

Non-Foods Manufacturer Line-Up**Page 2****Tabletop****Pages 3-109****Buffet & Catering****Pages 110-123****Dining/Table Service****Pages 124-147****Bar Service****Pages 148-155****Equipment/Countertop/Concession****Pages 156-180****Kitchen****Pages 181-283****Janitorial****Pages 284-302****Disposable/Chemical****Pages 303-310****Numerical Index (by Manufacturer & Item #)****Pages 311-334****General Index (by Product Name)****Pages 335-345****Reference & Buyer's Resource Guides/Manufacturers' Websites** **Pages 346-352**

EQUIPMENT & SUPPLY

- ALLIED**
- Anchor**
Anchor Hooking Foodservice
- APW**
uYou
- Arden Benhar**
Foodservice & Institutional
- Bar Maid**
- BLAZE**
- BLOOMFIELD**
- BUNN**
- CAMBRO**
TRUSTED FOR GENERATIONS™
- Cardinal**
- CARLISLE**
FoodService Products
- MARKO CARLISLE**
- CHEF-MASTER**
- MIR. BAR-B-Q**
- Chef**
- CREWWARE**
TOUGH AND SANITARY
- Copper ATKINS**
- DEXTER**
THE EDGE. BIFICE. HUB.
- Etlund**
- FOCUS**
FOODSERVICE, LLC
- regalware**
FOOD SERVICE

- G.E.T.**
- Hall**
The Hall China Company
- Hamilton Beach**
COMMERCIAL
- JACCARD**
- Libbey**
A Libbey FOODSERVICE Company
- TRAEX**
A Libbey FOODSERVICE Company
- WORLD TABLEWARE**
A Libbey FOODSERVICE Company
- Syracuse**
CHINA
A Libbey FOODSERVICE Company
- MUNDIAL**
- NEMCO**
FOOD EQUIPMENT
"Exceeding your expectations"
- ONEIDA**
- SANT'ANDREA**
- BUFFALO**
- DELCO**
- REGO**
- ProctorSilex**
- SAN JAMAR**
Smart • Safe • Sanitary
- SERVING SOLUTIONS**
- The STERNO GROUP**
- TABLECRAFT**
EVERY TABLE. EVERY DAY.
- TAYLOR**
- T&S**
RELIABILITY BUILT IN™
- update**
international

- Vertex**
CHINA
- Vitamix**
- VICTORINOX**
SWISS ARMY
- VOLLRATH**
Setting the Standard™
- WALCO**
- WARING**
COMMERCIAL
- WELLS**
WELLS
- Winco**
The Professional Answer to The Food Service Industry
- WIN-HOLT**
EQUIPMENT

JANITORIAL

- 3M**
- APEX**
CLEANING SOLUTIONS
- CACTUS MAT MFG. CO.**
- CONTINENTAL**
COMMERCIAL PRODUCTS
- DISCO**
- WILEN**
PROFESSIONAL CLEANING PRODUCTS
- HAVELLS**
powering lives
- SOULCO**

DISPOSABLE / CHEMICAL

- cedar**
Commercial
Makes Your Life Easier!
- ORECK**
COMMERCIAL
- AJAJM**
PACKAGING CORPORATION
- Boyd Products**
- DayMark**
Safety Systems
- DISCOVERY**
Products Corporation
- Diversey**
- GOLDMAX**
- HFA Inc.**
Handi-foil of America
- HANDY WACKS**
COMMERCIAL
- Handguards INC.**
- NCCO**
NATIONAL COOKING CONTAINERS
- Procter & Gamble Professional™**
- Reckitt Benckiser PROFESSIONAL**
- Reynolds**
Food Packaging
- SHEILA SHINE INC.**
- SMITH-LEE**
"Foodservice and a Thrive!"
- SPECTRUM PLASTICS, INC.**
...Global Packaging Solutions

GIBRALTAR®

LIBBEY®
+DuraTuff®

Libbey
GLASSWARE
A Libbey FOODSERVICE Company

TABLETOP



Rocks, 4½ oz
Item #369240
Mfg. #15248 +
H3⅝" T3"
B2½" D3"
Cs Pk 1 x 3 dz
Cs Wt 20.50 lb



Rocks, 5½ oz
Item #369505
Mfg. #15249 +
H3⅝" T3"
B2½" D3"
Cs Pk 1 x 3 dz
Cs Wt 16.00 lb



Rocks, 7 oz
Item #369243
Mfg. #15241 +
H3¼" T3⅝"
B2½" D3⅝"
Cs Pk 1 x 3 dz
Cs Wt 18.40 lb



Rocks, 8 oz
Item #368708
Mfg. #15240 +
H3⅝" T3⅝"
B2½" D3⅝"
Cs Pk 1 x 3 dz
Cs Wt 27.00 lb



Rocks, 9 oz
Item #368715
Mfg. #15242 +
H3⅝" T3⅝"
B2½" D3⅝"
Cs Pk 1 x 3 dz
Cs Wt 21.80 lb



Rocks, 10 oz
Item #369288
Mfg. #15232 +
H3⅝" T3½"
B2½" D3½"
Cs Pk 1 x 3 dz
Cs Wt 27.00 lb



Tall Rocks, 7 oz
Item #371321
Mfg. #15245 +
H3⅝" T3¼"
B2½" D3¼"
Cs Pk 1 x 3 dz
Cs Wt 26.00 lb



Tall Rocks, 9 oz
Item #369184
Mfg. #15231 +
H3⅝" T3½"
B2½" D3½"
Cs Pk 1 x 3 dz
Cs Wt 30.20 lb



Double Rocks, 12 oz
Item #368694
Mfg. #15243 +
H4" T3⅝"
B2¾" D3⅝"
Cs Pk 1 x 3 dz
Cs Wt 27.00 lb



Double Rocks, 13 oz
Item #370160
Mfg. #15233 +
H4½" T3¼"
B2¾" D3¼"
Cs Pk 1 x 3 dz
Cs Wt 32.00 lb



Hi-Ball, 7 oz
Item #369198
Mfg. #15239 +
H4½" T2⅝"
B2¼" D2⅝"
Cs Pk 1 x 3 dz
Cs Wt 20.00 lb



Hi-Ball, 9 oz
Item #369171
Mfg. #15236 +
H4¾" T3⅝"
B2½" D3⅝"
Cs Pk 1 x 3 dz
Cs Wt 33.00 lb



Beverage, 10 oz
Item #368721
Mfg. #15237 +
H4¾" T3⅝"
B2½" D3⅝"
Cs Pk 1 x 3 dz
Cs Wt 31.00 lb



Beverage, 12 oz
Item #368799
Mfg. #15238 +
H4⅝" T3¼"
B2⅝" D3¼"
Cs Pk 1 x 3 dz
Cs Wt 36.00 lb



Beverage, 14 oz
Item #368798
Mfg. #15244 +
H5⅝" T3½"
B2¾" D3½"
Cs Pk 1 x 3 dz
Cs Wt 37.00 lb



Cooler, 12 oz
Item #369156
Mfg. #15235 +
H5⅝" T3⅝"
B2¼" D3⅝"
Cs Pk 1 x 3 dz
Cs Wt 32.00 lb



Cooler, 16 oz
Item #388106
Mfg. #15256 +
H6⅝" T3⅝"
B2½" D3⅝"
Cs Pk 1 x 2 dz
Cs Wt 28.90 lb



Cooler, 20 oz
Item #390501
Mfg. #15665 +
H6¾" T3¼"
B2⅝" D3¼"
Cs Pk 1 x 2 dz
Cs Wt 28.90 lb



+ DuraTuff®

Sold in case pack only.

GIBRALTAR®

LIBBEY®
+DuraTuff®



Iced Tea, 22 oz
Item #368697
Mfg. #15253 +
H7" T3¾"
B2¾" D3¾"
Cs Pk 1 x 2 dz
Cs Wt 38.00 lb



Wine, 8½ oz
Item #370267
Mfg. #15246 +
H6¼" T3½"
B3" D3½"
Cs Pk 1 x 3 dz
Cs Wt 30.00 lb



Goblet, 11½ oz
Item #368714
Mfg. #15247 +
H6¾" T3¾"
B3½" D3¾"
Cs Pk 1 x 3 dz
Cs Wt 35.00 lb

FOOTED GIBRALTAR®



Footed Pilsner, 14 oz
Item #389014
Mfg. #15429 +
H7¼" T3¼"
B2¾" D3¼"
Cs Pk 1 x 2 dz
Cs Wt 34.70 lb



Footed Pilsner, 16¼ oz
Item #406640
Mfg. #15673 +
H8" T3¾"
B2¾" D3¾"
Cs Pk 1 x 1 dz
Cs Wt 18.90 lb

STACKABLE GIBRALTAR®

LIBBEY®
+DuraTuff®

Libbey
GLASSWARE®
A Libbey FOODSERVICE Company



Rocks, 7 oz
Item #370360
Mfg. #15661 +
H3½" T3½"
B1¾" D3¼"
Cs Pk 1 x 3 dz
Cs Wt 17.00 lb



Rocks, 9 oz
Item #370875
Mfg. #15659 +
H3¾" T3¼"
B2¾" D3¼"
Cs Pk 1 x 3 dz
Cs Wt 20.00 lb



Hi-Ball, 9 oz
Item #370189
Mfg. #15656 +
H4½" T3"
B2¼" D3"
Cs Pk 1 x 3 dz
Cs Wt 24.00 lb



Beverage, 12 oz
Item #369435
Mfg. #15654 +
H5" T3½"
B2¾" D3½"
Cs Pk 1 x 3 dz
Cs Wt 26.00 lb



Beverage, 14 oz
Item #369535
Mfg. #15652 +
H5¼" T3¼"
B2¾" D3¼"
Cs Pk 1 x 3 dz
Cs Wt 29.00 lb



Cooler, 16 oz
Item #369608
Mfg. #15651 +
H6¾" T3¼"
B2½" D3¼"
Cs Pk 1 x 3 dz
Cs Wt 36.00 lb

EMBASSY®



Libbey
GLASSWARE®
A Libbey FOODSERVICE Company



Wine, 6½ oz
Item #455743
Mfg. #3769 ■
H5¾" T2¾"
B2½" D2¾"
Cs Pk 1 x 2 dz
Cs Wt 10.80 lb



Wine, 8½ oz
Item #452222
Mfg. #3764 ■
H5¾" T2¾"
B2¼" D3½"
Cs Pk 1 x 2 dz
Cs Wt 11.05 lb



Wine, 10½ oz
Item #368727
Mfg. #3757 ■
H6" T3½"
B2¼" D3¾"
Cs Pk 1 x 3 dz
Cs Wt 20.00 lb



Wine, 6½ oz
Item #368807
Mfg. #3766 ■
H6¼" T2½"
B2¾" D2¾"
Cs Pk 1 x 3 dz
Cs Wt 17.00 lb



Wine, 8½ oz
Item #452921
Mfg. #3765 ■
H6¾" T2¾"
B2¼" D2¾"
Cs Pk 1 x 2 dz
Cs Wt 11.10 lb

Sold in case pack only.

+ DuraTuff® ■ Safedge® Rim and Foot Guarantee

EMBASSY®



Banquet Goblet, 10½ oz
Item #452220
Mfg. #3712 ■
H5¼" T2⅞"
B2⅞" D3⅞"
Cs Pk 1 x 2 dz
Cs Wt 13.60 lb



Goblet, 11½ oz
Item #452469
Mfg. #3711 ■
H6⅞" T2⅞"
B2¾" D3¼"
Cs Pk 1 x 2 dz
Cs Wt 12.60 lb



Goblet, 10¼ oz
Item #452223
Mfg. #3756 ■
H5¾" T3"
B2¾" D3"
Cs Pk 1 x 2 dz
Cs Wt 12.00 lb



Beer, 10 oz
Item #438414
Mfg. #3727 ■
H6¾" T2⅞"
B2¾" D2¾"
Cs Pk 1 x 2 dz
Cs Wt 11.50 lb



Beer, 12 oz
Item #452225
Mfg. #3728 ■
H7⅞" T2½"
B2¾" D2⅞"
Cs Pk 1 x 2 dz
Cs Wt 14.25 lb

TABLETOP



Footed Beer, 14 oz
Item #453268
Mfg. #3730 ■
H7⅞" T2½"
B2¾" D3"
Cs Pk 1 x 2 dz
Cs Wt 14.30 lb



Footed Beer, 12 oz
Item #370899
Mfg. #3725 ■
H7⅞" T2½"
B2¾" D2¾"
Cs Pk 1 x 3 dz
Cs Wt 22.00 lb



Footed Rocks, 5½ oz
Item #454341
Mfg. #3746 ■
H4⅞" T3⅞"
B2¾" D3⅞"
Cs Pk 1 x 2 dz
Cs Wt 13.10 lb



Footed Rocks, 7 oz
Item #453264
Mfg. #3747 ■
H4⅞" T3¼"
B2¾" D3¼"
Cs Pk 1 x 2 dz
Cs Wt 12.90 lb



Libbey
GLASSWARE
A Libbey FOODSERVICE Company



Brandy, 5½ oz
Item #369631
Mfg. #3702 ■
H4⅞" T2"
B2⅞" D2⅞"
Cs Pk 1 x 1 dz
Cs Wt 4.00 lb



Brandy, 9¼ oz
Item #369332
Mfg. #3704 ■
H4½" T2¼"
B2½" D3⅞"
Cs Pk 1 x 2 dz
Cs Wt 10.00 lb



Brandy, 11½ oz
Item #369167
Mfg. #3705 ■
H5" T2¼"
B2¾" D3⅞"
Cs Pk 1 x 2 dz
Cs Wt 11.00 lb



Brandy, 17½ oz
Item #369522
Mfg. #3708 ■
H5½" T2⅞"
B2¾" D4"
Cs Pk 1 x 2 dz
Cs Wt 14.00 lb



Brandy, 22 oz
Item #370327
Mfg. #3709 ■
H6" T2¾"
B2⅞" D4⅞"
Cs Pk 1 x 1 dz
Cs Wt 8.00 lb

■ Safedge® Rim and Foot Guarantee

Sold in case pack only.

EMBASSY®



Libbey
GLASSWARE®
A Libbey FOODSERVICE Company

TABLETOP



Champagne, 4½ oz
Item #368674
Mfg. #3777 ■
H4¼" T3¼"
B2¾" D3¾"
Cs Pk 1 x 3 dz
Cs Wt 14.00 lb



Champagne, 5½ oz
Item #369160
Mfg. #3773 ■
H4½" T3¼"
B2¾" D3¾"
Cs Pk 1 x 3 dz
Cs Wt 15.00 lb



Cordial, 1 oz
Item #370494
Mfg. #3793 ■
H4¼" T1½"
B1½" D1½"
Cs Pk 1 x 1 dz
Cs Wt 2.00 lb



Cordial, 1¼ oz
Item #370412
Mfg. #3790 ■
H4½" T1¼"
B1¾" D1¾"
Cs Pk 1 x 3 dz
Cs Wt 6.00 lb



Cocktail, 5 oz
Item #369269
Mfg. #3771 ■
H5¼" T3¼"
B2¾" D3¾"
Cs Pk 1 x 3 dz
Cs Wt 16.00 lb



Sherry, 3 oz
Item #450753
Mfg. #3788 ■
H4⅞" T2⅞"
B2¾" D2¾"
Cs Pk 1 x 1 dz
Cs Wt 4.00 lb



Brandy, 2 oz
Item #370240
Mfg. #3792 ■
H4¼" T1¾"
B1¾" D1¾"
Cs Pk 1 x 1 dz
Cs Wt 2.00 lb



Flute, 4½ oz
Item #369555
Mfg. #3794 ■
H7⅞" T1¼"
B2¾" D2¾"
Cs Pk 1 x 1 dz
Cs Wt 5.00 lb



Flute, 6 oz
Item #369175
Mfg. #3795 ■
H8⅞" T2"
B2¾" D2¾"
Cs Pk 1 x 1 dz
Cs Wt 6.00 lb



Cocktail, 7½ oz
Item #417899
Mfg. #3733 ■
H6⅜" T4¼"
B3" D4¼"
Cs Pk 1 x 1 dz
Cs Wt 7.40 lb



Martini, 9¼ oz
Item #370183
Mfg. #3779 ■
H6½" T4¾"
B3" D4¾"
Cs Pk 1 x 1 dz
Cs Wt 8.00 lb



Footed Hi-Ball, 8 oz
Item #453245
Mfg. #3736 ■
H5½" T2¾"
B2¾" D2¾"
Cs Pk 1 x 2 dz
Cs Wt 13.60 lb



Footed Hi-Ball, 10 oz
Item #450264
Mfg. #3737 ■
H6" T2⅞"
B2¾" D2⅞"
Cs Pk 1 x 2 dz
Cs Wt 14.00 lb



Banquet Goblet, 10½ oz
Item #453254
Mfg. #3752HT ■ ★
H5¼" T2⅞"
B2⅞" D3⅞"
Cs Pk 1 x 2 dz
Cs Wt 13.60 lb

Sold in case pack only.

★ Heat-Treated ■ Safedge® Rim and Foot Guarantee

EMBASSY ROYALE®



Iced Tea, 16¼ oz
Item #370115
Mfg. #3716 ■
H7" T3¼"
B3" D3½"
Cs Pk 1 x 3 dz
Cs Wt 28.00 lb



Tall Iced Tea, 16 oz
Item #372891
Mfg. #3750 ■
H8⅝" T2⅝"
B3" D3"
Cs Pk 1 x 3 dz
Cs Wt 24.00 lb



Banquet Goblet, 10½ oz
Item #369195
Mfg. #3721 ■
H6" T3"
B2¼" D3¼"
Cs Pk 1 x 3 dz
Cs Wt 20.75 lb



Poco Grande, 10½ oz
Item #369229
Mfg. #3715 ■
H7" T2⅝"
B2⅝" D3⅝"
Cs Pk 1 x 2 dz
Cs Wt 14.00 lb



Poco Grande, 13¼ oz
Item #369172
Mfg. #3717 ■
H7" T2⅝"
B3" D3⅝"
Cs Pk 1 x 1 dz
Cs Wt 7.00 lb

ATELIER



Tall Flute, 6 oz
Item #369308
Mfg. #3796 ■
H8¾" T2"
B2¾" D2¾"
Cs Pk 1 x 1 dz
Cs Wt 6.00 lb



Pinot Noir, 21 oz
Item #472332
Mfg. #08745/07 ◆❖
H8½" T2⅝"
B3⅝" D4⅝"
Cs Pk 1 x 1 dz
Cs Wt 7.00 lb



Cabernet/Merlot, 23¾ oz
Item #472348
Mfg. #08743/07 ◆❖
H9⅝" T2¾"
B3⅝" D4"
Cs Pk 1 x 1 dz
Cs Wt 7.00 lb



MICHELANGELO



All Purpose Burgunder, 13½ oz
Item #371352
Mfg. #C189ZX ◆
H7½" T3¼"
B3" D3¾"
Cs Pk 1 x 16 pcs
Cs Wt 11.00 lb



All Purpose Goblet, 19½ oz
Item #433415
Mfg. #C82ZX ◆
H7¾" T2¾"
B3" D3½"
Cs Pk 1 x 2 dz
Cs Wt 20.00 lb



Martini, 7¼ oz
Item #376195
Mfg. #C211ZX ◆
H6¾" T4⅝"
B2¾" D4⅝"
Cs Pk 1 x 2 dz
Cs Wt 11.00 lb

■ Safedge® Rim and Foot Guarantee ◆ Luigi Bormioli ❖ SON.hyx Rim and Foot Guarantee

Sold in case pack only.

MICHELANGELO®



A Libbey FOODSERVICE Partner

VAN GOGH

RIGOLETTO



Rocks/Juice Tumbler, 9 oz
Item #374970
Mfg. #PM521ZX ◆
H4" T2¾"
B2½" D2"
Cs Pk 1 x 2 dz
Cs Wt 15.00 lb



Double Old Fashioned, 11¼ oz
Item #377051
Mfg. #PM515ZX ◆
H4¼" T3"
B2¼" D3½"
Cs Pk 1 x 2 dz
Cs Wt 17.00 lb



Beverage, 14¾ oz
Item #374968
Mfg. #PM514ZX ◆
H6½" T2⅝"
B2" D2¾"
Cs Pk 1 x 2 dz
Cs Wt 20.00 lb



Pilsner, 15½ oz
Item #440803
Mfg. #C269ZX ◆
H8½" T2⅝"
B2¾" D2⅞"
Cs Pk 1 x 2 dz
Cs Wt 18.00 lb



Flute, 6¾ oz
Item #374020
Mfg. #C145ZX ◆
H9⅞" T2⅞"
B2¾" D2¾"
Cs Pk 1 x 2 dz
Cs Wt 11.00 lb

VINA™

LIBBEY®
▲ FINEEDGE®



Libbey
GLASSWARE
A Libbey FOODSERVICE Company



Flute, 8 oz
Item #406634
Mfg. #7500 ●▲
H9¼" T2"
B3¼" D3¼"
Cs Pk 1 x 1 dz
Cs Wt 5.80 lb



Tall Wine, 18½ oz
Item #406633
Mfg. #7504 ●▲
H9⅞" T2⅞"
B3¼" D3⅝"
Cs Pk 1 x 1 dz
Cs Wt 7.90 lb



Wine Taster, 12¾ oz
Item #402722
Mfg. #7508 ●▲
H8¼" T2½"
B3¼" D3⅝"
Cs Pk 1 x 1 dz
Cs Wt 5.50 lb



Tall Wine, 16 oz
Item #402726
Mfg. #7510 ●▲
H9" T2⅞"
B3¼" D3½"
Cs Pk 1 x 1 dz
Cs Wt 7.10 lb



Balloon, 13½ oz
Item #401940
Mfg. #7503 ●▲
H7⅝" T3¼"
B3¼" D3⅝"
Cs Pk 1 x 1 dz
Cs Wt 7.30 lb



Balloon, 16 oz
Item #402725
Mfg. #7509 ●▲
H7⅞" T3⅝"
B3¼" D3⅞"
Cs Pk 1 x 1 dz
Cs Wt 8.06 lb



Tall Wine, 12 oz
Item #406359
Mfg. #7502 ●▲
H8⅞" T3"
B3¼" D3⅝"
Cs Pk 1 x 1 dz
Cs Wt 6.00 lb



Grand Wine Taster, 16 oz
Item #411651
Mfg. #7551 ●▲
H9" T2⅝"
B3⅝" D3⅞"
Cs Pk 1 x 1 dz
Cs Wt 7.80 lb



Trumpet Flute, 6½ oz
Item #439103
Mfg. #7552 ●▲
H9¾" T2¼"
B3¼" D3¼"
Cs Pk 1 x 1 dz
Cs Wt 6.50 lb

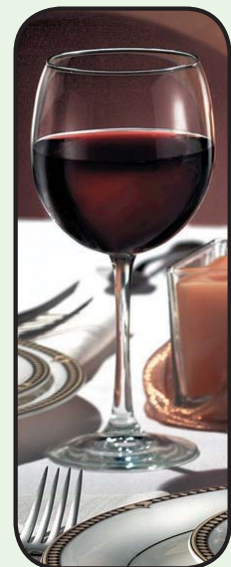

VINA™



Balloon, 18¼ oz
Item #406362
Mfg. #7505 ●▲
H8¼" T3⅞"
B3¼" D4"
Cs Pk 1 x 1 dz
Cs Wt 7.60 lb

LIBBEY®
▲FINEDGE®



Martini, 8 oz
Item #411639
Mfg. #7512 ●▲
H6⅞" T4⅞"
B3¼" D4⅞"
Cs Pk 1 x 1 dz
Cs Wt 6.00 lb



Goblet, 16 oz
Item #425775
Mfg. #7513 ●▲
H6⅞" T2⅞"
B3¼" D3½"
Cs Pk 1 x 1 dz
Cs Wt 6.45 lb

VINA II™



Tall Wine, 16 oz
Item #451172
Mfg. #7510SR ✖
H9" T2⅞"
B3¼" D3½"
Cs Pk 1 x 1 dz
Cs Wt 7.10 lb



Grand Wine, 18¼ oz
Item #411641
Mfg. #7555SR ✖
H9⅝" T2⅞"
B3⅝" D3⅝"
Cs Pk 1 x 1 dz
Cs Wt 8.30 lb



TABLETOP

BRISTOL VALLEY



Round Wine, 13½ oz
Item #370287
Mfg. #8515SR ✖
H6⅞" T3¼"
B3¼" D3⅞"
Cs Pk 1 x 2 dz
Cs Wt 14.00 lb



Red Wine, 9½ oz
Item #370535
Mfg. #8541SR ✖
H6⅞" T3"
B2¾" D3¼"
Cs Pk 1 x 2 dz
Cs Wt 10.00 lb



Cocktail, 7½ oz
Item #370197
Mfg. #8555SR ✖
H6¼" T4¼"
B3¼" D4¼"
Cs Pk 1 x 2 dz
Cs Wt 13.40 lb



Goblet, 12 oz
Item #370345
Mfg. #8556SR ✖
H5½" T3"
B2⅞" D3⅞"
Cs Pk 1 x 2 dz
Cs Wt 13.00 lb



Iced Tea, 16 oz
Item #415853
Mfg. #8513SR ✖
H6⅞" T2⅞"
B3¼" D3½"
Cs Pk 1 x 2 dz
Cs Wt 11.900 lb



White Wine, 8½ oz
Item #370565
Mfg. #8564SR ✖
H6¾" T2⅞"
B2¾" D2⅞"
Cs Pk 1 x 2 dz
Cs Wt 11.00 lb



White Wine, 13 oz
Item #370562
Mfg. #8573SR ✖
H7½" T2⅞"
B3¼" D3⅞"
Cs Pk 1 x 2 dz
Cs Wt 12.80 lb



Chalice Wine, 8½ oz
Item #370529
Mfg. #8565SR ✖
H6⅞" T2¼"
B2¾" D3"
Cs Pk 1 x 2 dz
Cs Wt 11.00 lb



Chalice Wine, 12½ oz
Item #370357
Mfg. #8572SR ✖
H7½" T3⅞"
B3¼" D3⅞"
Cs Pk 1 x 2 dz
Cs Wt 15.00 lb



Sherry, 3¾ oz
Item #370274
Mfg. #8588SR ✖
H5⅞" T1⅝"
B2¼" D2¼"
Cs Pk 1 x 2 dz
Cs Wt 6.50 lb

▲ Finedge® ● Safedge® Rim Guarantee ✖ Sheer Rim/D.T.E.™

Sold in case pack only.

DOMAINE

Design Patented



Wine, 8½ oz
Item #369672
 Mfg. #8941 ●
 H7" T3"
 B2⅝" D3⅛"
 Cs Pk 1 x 1 dz
 Cs Wt 5.20 lb



Banquet Goblet, 13 oz
Item #369498
 Mfg. #8956 ●
 H5⅝" T3⅝"
 B2⅞" D3½"
 Cs Pk 1 x 1 dz
 Cs Wt 6.30 lb



Martini, 8 oz
Item #371309
 Mfg. #8978 ●
 H7" T4½"
 B3" D4½"
 Cs Pk 1 x 1 dz
 Cs Wt 6.70 lb



Flute, 6 oz
Item #370374
 Mfg. #8995 ●
 H8⅞" T2"
 B2¾" D2¾"
 Cs Pk 1 x 1 dz
 Cs Wt 6.00 lb

CITATION



Tall Wine, 6½ oz
Item #369370
 Mfg. #8466 ●
 H6⅞" T2⅞"
 B2½" D2½"
 Cs Pk 1 x 3 dz
 Cs Wt 12.00 lb



White Wine, 11 oz
Item #453592
 Mfg. #8472 ●
 H6⅞" T2⅝"
 B2¾" D3¼"
 Cs Pk 1 x 2 dz
 Cs Wt 10.40 lb



All Purpose Wine, 7¾ oz
Item #369215
 Mfg. #8470 ●
 H5⅝" T2¼"
 B2½" D2¾"
 Cs Pk 1 x 3 dz
 Cs Wt 13.00 lb



Burgundy Wine, 8½ oz
Item #369395
 Mfg. #8471 ●
 H5⅝" T2¾"
 B2¾" D3¼"
 Cs Pk 1 x 3 dz
 Cs Wt 16.00 lb



Brandy, 6 oz
Item #370374
 Mfg. #8402 ●
 H3¾" T2"
 B2⅝" D3"
 Cs Pk 1 x 1 dz
 Cs Wt 4.00 lb



Brandy, 12 oz
Item #370365
 Mfg. #8405 ●
 H4⅞" T2½"
 B2¾" D3⅝"
 Cs Pk 1 x 3 dz
 Cs Wt 15.00 lb



Red Wine, 12 oz
Item #369173
 Mfg. #8414 ●
 H5⅝" T3"
 B2¾" D3⅝"
 Cs Pk 1 x 3 dz
 Cs Wt 18.00 lb



Banquet Goblet, 11 oz
Item #369252
 Mfg. #8411 ●
 H6" T2½"
 B2⅞" D3"
 Cs Pk 1 x 3 dz
 Cs Wt 17.00 lb



Goblet, 10 oz
Item #453258
 Mfg. #8456 ●
 H7" T2⅝"
 B2¾" D3"
 Cs Pk 1 x 2 dz
 Cs Wt 10.70 lb

NAPA COUNTRY



White Wine, 7¾ oz
Item #370237
 Mfg. #8764 ●
 H6¾" T2⅝"
 B2⅝" D2¾"
 Cs Pk 1 x 3 dz
 Cs Wt 14.00 lb



Flute, 5¾ oz
Item #369556
 Mfg. #8795 ●
 H7⅞" T1⅞"
 B2⅝" D2⅝"
 Cs Pk 1 x 1 dz
 Cs Wt 5.00 lb

CITATION



Libbey
GLASSWARE
A Libbey FOODSERVICE Company



TABLETOP



Wine/Ber, 8 oz
Item #452221
Mfg. #8464 ●
H6¾" T2¾"
B2½" D2¾"
Cs Pk 1 x 2 dz
Cs Wt 10.10 lb



Pilsner, 12 oz
Item #369223
Mfg. #8425 ●
H8¼" T3"
B3" D3"
Cs Pk 1 x 2 dz
Cs Wt 15.00 lb



Cocktail, 4½ oz
Item #369264
Mfg. #8454 ●
H5½" T3½"
B2¾" D3½"
Cs Pk 1 x 3 dz
Cs Wt 14.00 lb



Cocktail, 6 oz
Item #368704
Mfg. #8455 ●
H5½" T4¼"
B2¾" D4¼"
Cs Pk 1 x 3 dz
Cs Wt 16.00 lb



Flute, 6¼ oz
Item #377479
Mfg. #8495 ●
H7¼" T1¾"
B2½" D2½"
Cs Pk 1 x 1 dz
Cs Wt 5.00 lb

CITATION GOURMET™



Coupette-Margarita, 7 oz
Item #371316
Mfg. #8428 ●
H5½" T4½"
B3" D4½"
Cs Pk 1 x 1 dz
Cs Wt 7.00 lb



Coupette-Margarita, 9 oz
Item #369201
Mfg. #8429 ●
H6½" T4½"
B3" D4½"
Cs Pk 1 x 1 dz
Cs Wt 7.00 lb



Tall Wine, 12 oz
Item #368634
Mfg. #8412 ●
H7¾" T2¾"
B3" D3¾"
Cs Pk 1 x 1 dz
Cs Wt 7.00 lb



Round Wine, 13¾ oz
Item #369205
Mfg. #8415 ●
H6½" T3¼"
B3" D4"
Cs Pk 1 x 1 dz
Cs Wt 6.00 lb



Tulip Champagne, 6 oz
Item #369326
Mfg. #8477 ●
H7¾" T2½"
B2¾" D2¾"
Cs Pk 1 x 1 dz
Cs Wt 5.00 lb



Tulip Champagne, 9 oz
Item #368724
Mfg. #8476 ●
H8½" T2¼"
B2¾" D2¾"
Cs Pk 1 x 1 dz
Cs Wt 6.00 lb

PERCEPTION



Libbey
GLASSWARE
A Libbey FOODSERVICE Company



Red Wine, 8 oz
Item #370539
Mfg. #3064 ■
H7" T2¾"
B2¾" D3½"
Cs Pk 1 x 2 dz
Cs Wt 12.10 lb



Red Wine, 10 oz
Item #370455
Mfg. #3056 ■
H7½" T2¾"
B2¾" D3¾"
Cs Pk 1 x 2 dz
Cs Wt 13.40 lb



Red Wine, 13½ oz
Item #369641
Mfg. #3014 ■
H7¾" T2¾"
B3" D3¾"
Cs Pk 1 x 2 dz
Cs Wt 15.80 lb



Wine, 8 oz
Item #370312
Mfg. #3065 ■
H7¼" T2¾"
B2¾" D3"
Cs Pk 1 x 2 dz
Cs Wt 12.60 lb



Wine, 11 oz
Item #368794
Mfg. #3057 ■
H7½" T2½"
B2¾" D3½"
Cs Pk 1 x 2 dz
Cs Wt 14.00 lb

● Safedge® Rim Guarantee ■ Safedge® Rim and Foot Guarantee

Sold in case pack only.

PERCEPTION



Tall Wine, 20 oz
Item #406636
Mfg. #3060 ■
H8⁷/₈" T3¹/₈"
B3¹/₄" D3³/₈"
Cs Pk 1 x 1 dz
Cs Wt 9.60 lb



Tall Goblet, 14 oz
Item #370219
Mfg. #3011 ■
H8¹/₄" T2³/₄"
B3" D3³/₈"
Cs Pk 1 x 2 dz
Cs Wt 16.60 lb



Banquet Goblet, 14 oz
Item #394369
Mfg. #3010 ■
H6¹/₂" T2³/₄"
B3" D3³/₈"
Cs Pk 1 x 2 dz
Cs Wt 17.60 lb



Flute, 5³/₄ oz
Item #385990
Mfg. #3096 ■
H8¹/₂" T1⁷/₈"
B2³/₄" D2³/₄"
Cs Pk 1 x 1 dz
Cs Wt 5.90 lb



Cordial, 4¹/₈ oz
Item #373776
Mfg. #3088 ■
H5⁵/₈" T2"
B2¹/₄" D2⁵/₈"
Cs Pk 1 x 2 dz
Cs Wt 7.30 lb



Rocks Tumbler, 9 oz
Item #391456
Mfg. #2392 ●
H3⁵/₈" T2⁵/₈"
B2¹/₂" D3¹/₈"
Cs Pk 1 x 2 dz
Cs Wt 16.70 lb

TEARDROP



White Wine, 6¹/₂ oz
Item #370241
Mfg. #3966 ■
H6¹/₄" T2⁵/₈"
B2⁵/₈" D2³/₄"
Cs Pk 1 x 3 dz
Cs Wt 15.00 lb



White Wine, 8¹/₂ oz
Item #453249
Mfg. #3965 ■
H7⁷/₈" T2⁵/₈"
B2³/₄" D3"
Cs Pk 1 x 2 dz
Cs Wt 12.40 lb



Red Wine, 6¹/₂ oz
Item #370114
Mfg. #3969 ■
H5³/₄" T2⁵/₈"
B2⁵/₈" D3"
Cs Pk 1 x 3 dz
Cs Wt 14.00 lb



Red Wine, 8¹/₂ oz
Item #370864
Mfg. #3964 ■
H6¹/₈" T2³/₄"
B2⁷/₈" D3¹/₄"
Cs Pk 1 x 3 dz
Cs Wt 18.00 lb



All Purpose Wine, 10³/₄ oz
Item #369577
Mfg. #3957 ■
H7¹/₄" T2³/₄"
B2⁷/₈" D3¹/₄"
Cs Pk 1 x 3 dz
Cs Wt 20.00 lb



Flute, 5³/₄ oz
Item #370211
Mfg. #3996 ■
H7³/₄" T2"
B2³/₄" D2³/₄"
Cs Pk 1 x 1 dz
Cs Wt 6.00 lb



Goblet, 12 oz
Item #370519
Mfg. #3911 ■
H7¹/₄" T2⁵/₈"
B2⁷/₈" D3³/₈"
Cs Pk 1 x 3 dz
Cs Wt 22.50 lb



Goblet, 10¹/₂ oz
Item #370785
Mfg. #3914 ■
H5¹/₂" T3"
B2³/₄" D3¹/₄"
Cs Pk 1 x 3 dz
Cs Wt 18.00 lb



Beer, 14³/₄ oz
Item #369460
Mfg. #3915 ■
H7" T2¹/₂"
B2⁷/₈" D3¹/₄"
Cs Pk 1 x 3 dz
Cs Wt 29.00 lb

ESTATE



Wine, 8¹/₂ oz
Item #369438
Mfg. #3364 ■
H5⁵/₈" T2⁵/₈"
B2³/₄" D3¹/₈"
Cs Pk 1 x 3 dz
Cs Wt 20.00 lb



All Purpose Goblet, 10¹/₂ oz
Item #370578
Mfg. #3312 ■
H5¹/₂" T2⁵/₈"
B2³/₄" D3¹/₈"
Cs Pk 1 x 3 dz
Cs Wt 21.00 lb

CATALINA®



Libbey
GLASSWARE
A Libbey FOODSERVICE Company



Rocks/Sherbet, 7 oz
Item #370172
Mfg. #3824 ■
H4¼" T3⅝"
B3" D3⅝"
Cs Pk 1 x 3 dz
Cs Wt 24.00 lb



Dessert, 10 oz
Item #370416
Mfg. #3825 ■
H3⅞" T4¼"
B3" D4¼"
Cs Pk 1 x 3 dz
Cs Wt 25.00 lb



Cordial, 2 oz
Item #370271
Mfg. #3826 ■
H4⅝" T1⅝"
B2" D2"
Cs Pk 1 x 3 dz
Cs Wt 9.00 lb



Wine, 8½ oz
Item #370497
Mfg. #3820 ■
H5¼" T3⅝"
B2¼" D3⅝"
Cs Pk 1 x 3 dz
Cs Wt 22.00 lb



Margarita, 12 oz
Item #370167
Mfg. #3827 ■
H4⅞" T4⅞"
B3" D4⅞"
Cs Pk 1 x 3 dz
Cs Wt 29.00 lb



Pilsner, 12 oz
Item #370097
Mfg. #3828 ■
H9" T2⅝"
B3" D3"
Cs Pk 1 x 2 dz
Cs Wt 22.60 lb



Tall Beer, 14 oz
Item #369502
Mfg. #3823 ■
H9⅞" T2¼"
B3¼" D3¼"
Cs Pk 1 x 2 dz
Cs Wt 24.00 lb

CHIVALRY®



Banquet Goblet, 10½ oz
Item #455342
Mfg. #3211 ■
H5⅝" T2⅞"
B2¼" D3¼"
Cs Pk 1 x 2 dz
Cs Wt 13.60 lb



Goblet, 12 oz
Item #368805
Mfg. #3212 ■
H6½" T3¼"
B3" D3⅝"
Cs Pk 1 x 3 dz
Cs Wt 30.00 lb



Beer, 12 oz
Item #369293
Mfg. #3228 ■
H7" T2½"
B2¼" D3⅝"
Cs Pk 1 x 3 dz
Cs Wt 25.00 lb



Wine, 8 oz
Item #370446
Mfg. #3264 ■
H6¼" T2⅞"
B2⅝" D3"
Cs Pk 1 x 3 dz
Cs Wt 20.00 lb

CHIVALRY®



Libbey
GLASSWARE
A Libbey FOODSERVICE Company



Juice, 6 oz
Item #369524
Mfg. #2481 ●
H3¾" T2⅝"
B2⅞" D2⅞"
Cs Pk 1 x 3 dz
Cs Wt 15.00 lb



Rocks, 8 oz
Item #370518
Mfg. #2484 ●
H3⅝" T3⅝"
B2½" D3⅝"
Cs Pk 1 x 3 dz
Cs Wt 19.00 lb



Rocks, 10 oz
Item #369270
Mfg. #2485 ●
H3⅝" T3¼"
B2⅞" D3⅝"
Cs Pk 1 x 3 dz
Cs Wt 24.00 lb



Cooler, 16 oz
Item #369582
Mfg. #2486 ●
H6⅞" T3"
B2⅞" D3¼"
Cs Pk 1 x 3 dz
Cs Wt 28.00 lb



Beverage, 10 oz
Item #369441
Mfg. #2489 ●
H4¾" T2¾"
B2⅞" D3"
Cs Pk 1 x 3 dz
Cs Wt 20.00 lb



Beverage, 12 oz
Item #369446
Mfg. #2488 ●
H5¼" T2⅞"
B2¼" D3⅝"
Cs Pk 1 x 3 dz
Cs Wt 26.00 lb

● Safedge® Rim Guarantee ■ Safedge® Rim and Foot Guarantee

Sold in case pack only.

LEXINGTON



Footed Hi-Ball, 10 oz
Item #370253
Mfg. #3537 ■
H5⁵/₈" T2⁵/₈"
B2¹/₂" D2⁵/₈"
Cs Pk 1 x 3 dz
Cs Wt 20.00 lb



Goblet, 11 oz
Item #370499
Mfg. #3556 ■
H6¹/₄" T2⁷/₈"
B2⁵/₈" D2⁷/₈"
Cs Pk 1 x 3 dz
Cs Wt 20.00 lb



Juice, 5 oz
Item #370123
Mfg. #2349 ●
H3¹/₂" T2¹/₄"
B2¹/₄" D2¹/₄"
Cs Pk 1 x 3 dz
Cs Wt 14.00 lb



Old Fashioned, 7³/₄ oz
Item #369526
Mfg. #2328 ●
H3¹/₂" T2⁷/₈"
B2³/₄" D2⁷/₈"
Cs Pk 1 x 3 dz
Cs Wt 20.00 lb



Old Fashioned, 10¹/₄ oz
Item #369233
Mfg. #2338 ●
H3¹/₂" T3¹/₄"
B3¹/₈" D3¹/₄"
Cs Pk 1 x 3 dz
Cs Wt 26.00 lb



Double Old Fashioned, 12¹/₂ oz
Item #369256
Mfg. #2339 ●
H4" T3¹/₄"
B3¹/₈" D3¹/₄"
Cs Pk 1 x 3 dz
Cs Wt 28.00 lb



Hi-Ball, 8 oz
Item #370124
Mfg. #2318 ●
H4¹/₂" T2³/₈"
B2⁵/₈" D2³/₈"
Cs Pk 1 x 3 dz
Cs Wt 19.00 lb



Hi-Ball, 9 oz
Item #369578
Mfg. #2325 ●
H4³/₄" T2¹/₂"
B2¹/₂" D2¹/₂"
Cs Pk 1 x 3 dz
Cs Wt 20.65 lb



Tall Hi-Ball, 10 oz
Item #369513
Mfg. #2310 ●
H6" T2¹/₂"
B2¹/₄" D2¹/₂"
Cs Pk 1 x 3 dz
Cs Wt 21.50 lb



Beverage, 11¹/₄ oz
Item #370138
Mfg. #2359 ●
H5" T2³/₄"
B2³/₄" D2³/₄"
Cs Pk 1 x 3 dz
Cs Wt 23.40 lb



Cooler 15¹/₂ oz
Item #369536
Mfg. #2369 ●
H5⁵/₈" T2⁷/₈"
B2⁷/₈" D2⁷/₈"
Cs Pk 1 x 3 dz
Cs Wt 28.00 lb

WINCHESTER



Wine, 6¹/₂ oz
Item #370391
Mfg. #15463 +
H5¹/₄" T2⁵/₈"
B2¹/₂" D2³/₄"
Cs Pk 1 x 3 dz
Cs Wt 23.25 lb



Wine, 8¹/₂ oz
Item #370169
Mfg. #15464 +
H5⁵/₈" T2⁵/₈"
B2³/₄" D3"
Cs Pk 1 x 3 dz
Cs Wt 26.00 lb



Goblet, 10¹/₂ oz
Item #368665
Mfg. #15465 +
H6" T3¹/₄"
B2⁷/₈" D3¹/₈"
Cs Pk 1 x 3 dz
Cs Wt 35.00 lb



Rocks, 5¹/₂ oz
Item #369508
Mfg. #15453 +
H3³/₈" T2⁷/₈"
B2¹/₄" D2⁷/₈"
Cs Pk 1 x 3 dz
Cs Wt 23.00 lb



Rocks, 8 oz
Item #369174
Mfg. #15454 +
H3³/₈" T3¹/₈"
B2¹/₂" D3¹/₈"
Cs Pk 1 x 3 dz
Cs Wt 21.00 lb



Rocks, 10 oz
Item #369231
Mfg. #15457 +
H3³/₈" T3³/₈"
B2³/₈" D3³/₈"
Cs Pk 1 x 3 dz
Cs Wt 23.00 lb



Hi-Ball, 6³/₄ oz
Item #369553
Mfg. #15451 +
H4³/₈" T2¹/₂"
B1⁷/₈" D2¹/₂"
Cs Pk 1 x 3 dz
Cs Wt 19.00 lb



Hi-Ball, 8³/₄ oz
Item #369285
Mfg. #15456 +
H5" T2³/₄"
B2" D2³/₄"
Cs Pk 1 x 3 dz
Cs Wt 22.40 lb



Beverage, 12 oz
Item #368699
Mfg. #15458 +
H5⁵/₈" T3"
B2¹/₈" D3"
Cs Pk 1 x 3 dz
Cs Wt 24.50 lb



Cooler, 16 oz
Item #369467
Mfg. #15459 +
H5⁵/₈" T3¹/₄"
B2³/₈" D3¹/₄"
Cs Pk 1 x 3 dz
Cs Wt 35.00 lb

SUPER STEMS

Libbey
GLASSWARE
A Libbey FOODSERVICE Company



Super Globe, 51 oz
Item #370162
Mfg. #3408 ☼
H7 $\frac{1}{8}$ " T4 $\frac{1}{2}$ "
B4" D6 $\frac{1}{4}$ "
Cs Pk 1 x 6 ea
Cs Wt 11.00 lb



Super Schooner, 53 oz
Item #386111
Mfg. #3407 ☼
H8 $\frac{1}{2}$ " T4 $\frac{1}{2}$ "
B4" D6 $\frac{1}{4}$ "
Cs Pk 1 x 6 ea
Cs Wt 10.00 lb



Super Thistle, 15 oz
Item #369442
Mfg. #3402 ☼
H8 $\frac{1}{2}$ " T3 $\frac{3}{8}$ "
B3 $\frac{1}{2}$ " D3 $\frac{3}{8}$ "
Cs Pk 1 x 1 dz
Cs Wt 15.00 lb



Super Bowl, 38 oz
Item #369601
Mfg. #3403 ☼
H10 $\frac{1}{8}$ " T5 $\frac{3}{4}$ "
B4" D6 $\frac{1}{4}$ "
Cs Pk 1 x 6 ea
Cs Wt 10.00 lb



Super Martini, 44 oz
Item #370558
Mfg. #9570101 ☼
H10 $\frac{1}{8}$ " T9 $\frac{1}{4}$ "
B5 $\frac{1}{2}$ " D9 $\frac{1}{4}$ "
Cs Pk 1 x 6 ea
Cs Wt 18.00 lb

TABLETOP

SPECIALTY GLASSWARE



Libbey
GLASSWARE
A Libbey FOODSERVICE Company



Cosmopolitan
Cocktail, 8 $\frac{1}{4}$ oz
Item #395258
Mfg. #400 ●
H3 $\frac{3}{8}$ " T4" B2 $\frac{1}{4}$ " D4"
Cs Pk 1 x 1 dz
Cs Wt 8.30 lb



Cosmopolitan
Wine, 10 oz
Item #435120
Mfg. #401 ●
H4 $\frac{9}{16}$ " T3 $\frac{3}{8}$ " B2 $\frac{1}{4}$ " D3 $\frac{3}{8}$ "
Cs Pk 1 x 1 dz
Cs Wt 8.90 lb



Cosmopolitan Double
Old Fashioned, 14 oz
Item #442425
Mfg. #402 ●
H4 $\frac{9}{16}$ " T4 $\frac{3}{4}$ " B2 $\frac{3}{8}$ " D4 $\frac{1}{4}$ "
Cs Pk 1 x 1 dz
Cs Wt 11.50 lb



Cosmopolitan
Beverage, 14 oz
Item #434201
Mfg. #403 ●
H5 $\frac{3}{8}$ " T4" B2 $\frac{1}{2}$ " D4"
Cs Pk 1 x 1 dz
Cs Wt 10.70 lb



Martini Chiller, 5 $\frac{3}{4}$ oz
Item #420879
Mfg. #70855
H3 $\frac{1}{2}$ " T4 $\frac{1}{4}$ "
B2 $\frac{1}{2}$ " D4 $\frac{3}{8}$ "
Cs Pk 1 x 1 dz
Cs Wt 8.30 lb



Stemless Martini, 13 $\frac{1}{2}$ oz
Item #461169
Mfg. #224 ●
H3 $\frac{1}{2}$ " T4 $\frac{1}{2}$ "
B1 $\frac{3}{8}$ " D4 $\frac{1}{2}$ "
Cs Pk 1 x 1 dz
Cs Wt 5.90 lb



Stemless Red Wine, 16 $\frac{3}{4}$ oz
Item #458330
Mfg. #222 ●
H3 $\frac{3}{8}$ " T3 $\frac{3}{8}$ "
B1 $\frac{3}{4}$ " D3 $\frac{3}{8}$ "
Cs Pk 1 x 1 dz
Cs Wt 5.10 lb



Stemless White Wine, 11 $\frac{3}{4}$ oz
Item #489927
Mfg. #217 ●
H4" T2 $\frac{3}{8}$ "
B1 $\frac{1}{4}$ " D3 $\frac{1}{4}$ "
Cs Pk 1 x 1 dz
Cs Wt 3.90 lb



Stemless White Wine, 17 oz
Item #458329
Mfg. #221 ●
H4 $\frac{1}{2}$ " T2 $\frac{7}{8}$ "
B2" D3 $\frac{1}{2}$ "
Cs Pk 1 x 1 dz
Cs Wt 5.40 lb



Georgian Sherry, 2 oz
Item #369328
Mfg. #8089 ●
H4 $\frac{7}{8}$ " T2 $\frac{3}{8}$ "
B2 $\frac{1}{2}$ " D2 $\frac{1}{2}$ "
Cs Pk 1 x 3 dz
Cs Wt 11.00 lb

● Safedge® Rim Guarantee ☼ Hand Blown

Sold in case pack only.

SPECIALTY GLASSWARE

TABLETOP



Midtown™ Martini, 12 oz
Item #406635
Mfg. #7507 ●
H7³/₈" T4⁷/₈"
B3¹/₄" D4⁷/₈"
Cs Pk 1 x 1 dz
Cs Wt 7.00 lb



Midtown™ Margarita, 13 oz
Item #410327
Mfg. #7511 ●
H7¹/₂" T4³/₄"
B3³/₈" D4³/₄"
Cs Pk 1 x 1 dz
Cs Wt 7.90 lb



Cactus Margarita, 12 oz
Item #369262
Mfg. #3619JS ●
H6¹/₈" T3³/₄"
B3" D4"
Cs Pk 1 x 1 dz
Cs Wt 7.00 lb



Cactus Margarita, 16 oz
Item #369635
Mfg. #3620JS ●
H6¹/₄" T4³/₈"
B3" D4³/₈"
Cs Pk 1 x 1 dz
Cs Wt 8.00 lb



Z-Stem Martini, 5 oz
Item #369646
Mfg. #37719 ■
H5³/₈" T3³/₈"
B2³/₄" D3³/₈"
Cs Pk 1 x 1 dz
Cs Wt 5.00 lb



Z-Stem Martini, 7¹/₂ oz
Item #411567
Mfg. #37339 ■
H6³/₈" T4¹/₄"
B3" D4¹/₄"
Cs Pk 1 x 1 dz
Cs Wt 7.40 lb



Z-Stem Martini, 9¹/₄ oz
Item #369603
Mfg. #37799 ■
H6¹/₂" T4³/₈"
B3" D4³/₈"
Cs Pk 1 x 1 dz
Cs Wt 7.10 lb



Z-Stem Poco Grande, 13¹/₂ oz
Item #370569
Mfg. #37179 ■
H7⁵/₈" T3"
B2⁷/₈" D3³/₈"
Cs Pk 1 x 1 dz
Cs Wt 6.80 lb



Squall, 14¹/₂ oz
Item #369420
Mfg. #3616 ●
H8¹/₄" T3¹/₈"
B3" D3¹/₈"
Cs Pk 1 x 1 dz
Cs Wt 9.00 lb



Cyclone, 15 oz
Item #370184
Mfg. #3617 ●
H8¹/₄" T3¹/₈"
B3" D3¹/₈"
Cs Pk 1 x 1 dz
Cs Wt 8.90 lb



Hurricane, 23¹/₂ oz
Item #370382
Mfg. #3623 ●
H9³/₈" T3¹/₂"
B3" D3¹/₂"
Cs Pk 1 x 1 dz
Cs Wt 11.00 lb



Metropolis
Cocktail, 9³/₄ oz
Item #370316
Mfg. #3649LS ●
H7" T4⁷/₈"
B3¹/₄" D4⁷/₈"
Cs Pk 1 x 1 dz
Cs Wt 8.70 lb



Cocktail, 6¹/₂ oz
Item #369421
Mfg. #8876 ●
H6" T4¹/₄"
B3" D4¹/₄"
Cs Pk 1 x 3 dz
Cs Wt 18.00 lb



Bravura®
Tumbler, 16³/₄ oz
Item #431878
Mfg. #2212 ●
H6¹/₄" T2¹/₂"
B3¹/₈" D3³/₈"
Cs Pk 1 x 1 dz
Cs Wt 8.80 lb



Bravura®
Martini, 6³/₄ oz
Item #410673
Mfg. #7700 ●
H6³/₈" T4⁷/₈"
B3¹/₄" D4⁷/₈"
Cs Pk 1 x 1 dz
Cs Wt 7.60 lb



Bravura®
Martini, 6³/₄ oz
Item #413395
Mfg. #7700BS ●
H6³/₈" T4⁷/₈"
B3¹/₄" D4⁷/₈"
Cs Pk 1 x 1 dz
Cs Wt 7.60 lb



Omega®
Martini, 6³/₄ oz
Item #413030
Mfg. #8883 ●
H6¹/₂" T4⁷/₈"
B3¹/₄" D4⁷/₈"
Cs Pk 1 x 1 dz
Cs Wt 7.80 lb

GRANDE COLLECTION



Vino Grande™, 16 oz
Item #369657
Mfg. #8416 ●
H8½" T3"
B3" D3⅝"
Cs Pk 1 x 1 dz
Cs Wt 7.45 lb



Vino Grande™, 19½ oz
Item #370204
Mfg. #8420 ●
H8½" T3⅝"
B3" D3⅝"
Cs Pk 1 x 1 dz
Cs Wt 8.00 lb



Bolla Grande®, 17½ oz
Item #368718
Mfg. #8418 ●
H6⅝" T3⅝"
B3¼" D4⅜"
Cs Pk 1 x 1 dz
Cs Wt 8.00 lb



Magna Grande, 27¼ oz
Item #369655
Mfg. #8427 ●
H7⅝" T4½"
B3" D5"
Cs Pk 1 x 1 dz
Cs Wt 10.00 lb



Fiesta Grande®, 12 oz
Item #368660
Mfg. #8423 ●
H6" T4⅝"
B3⅝" D4½"
Cs Pk 1 x 1 dz
Cs Wt 7.00 lb



Fiesta Grande®, 15¼ oz
Item #369430
Mfg. #8422 ●
H6⅝" T4⅝"
B3" D5"
Cs Pk 1 x 1 dz
Cs Wt 8.50 lb



Fiesta Grande®, 16¾ oz
Item #369451
Mfg. #8417 ●
H6½" T4¼"
B3" D5"
Cs Pk 1 x 1 dz
Cs Wt 8.00 lb



Viva Grande®, 13 oz
Item #370165
Mfg. #8413 ●
H8⅝" T2⅝"
B3" D3⅝"
Cs Pk 1 x 1 dz
Cs Wt 7.00 lb



Salud Grande, 8½ oz
Item #432444
Mfg. #8485 ●
H6¼" T4½"
B3" D4½"
Cs Pk 1 x 1 dz
Cs Wt 7.40 lb



Salud Grande®, 10 oz
Item #368711
Mfg. #8480 ●
H6⅝" T4¼"
B3" D4¾"
Cs Pk 1 x 1 dz
Cs Wt 7.70 lb



INVERNESS™



Rocks, 7 oz
Item #451027
Mfg. #15480 +
H3¼" T3⅝"
B2⅝" D3⅝"
Cs Pk 1 x 2 dz
Cs Wt 17.90 lb



Rocks, 9 oz
Item #369341
Mfg. #15481 +
H3½" T3⅝"
B3⅝" D3⅝"
Cs Pk 1 x 3 dz
Cs Wt 35.00 lb



Double Old Fashioned, 12¼ oz
Item #455744
Mfg. #15482 +
H3⅝" T3¼"
B3⅝" D3¼"
Cs Pk 1 x 2 dz
Cs Wt 27.80 lb



Hi-Ball, 9 oz
Item #370601
Mfg. #15485 +
H5⅝" T2⅝"
B2⅝" D2⅝"
Cs Pk 1 x 3 dz
Cs Wt 26.00 lb



Beverage, 10 oz
Item #370358
Mfg. #15478 +
H5⅝" T3"
B2⅝" D3"
Cs Pk 1 x 3 dz
Cs Wt 33.00 lb



Beverage, 12 oz
Item #369169
Mfg. #15483 +
H5⅝" T3⅝"
B2¼" D3⅝"
Cs Pk 1 x 3 dz
Cs Wt 35.00 lb

+ DuraTuff® ● Safedge® Rim Guarantee

Sold in case pack only.

INVERNESS™

LIBBEY®
+DuraTuff®

ENDEAVOR™

LIBBEY®
+DuraTuff®

Libbey
GLASSWARE
A Libbey FOODSERVICE Company



Beverage, 14 oz
Item #370369
Mfg. #15479 +
H5¼" T3½"
B2½" D3½"
Cs Pk 1 x 3 dz
Cs Wt 40.00 lb



Cooler, 15¼ oz
Item #388112
Mfg. #15477 +
H6⅞" T3½"
B2½" D3½"
Cs Pk 1 x 2 dz
Cs Wt 29.20 lb



Rocks, 7 oz
Item #451129
Mfg. #15709 +
H3⅞" T3¼"
B2" D3¼"
Cs Pk 1 x 1 dz
Cs Wt 7.40 lb



Rocks, 9 oz
Item #451868
Mfg. #15710 +
H3⅞" T3½"
B2¼" D3½"
Cs Pk 1 x 1 dz
Cs Wt 8.70 lb



Double Old Fashioned,
12 oz
Item #460266
Mfg. #15712 +
H4⅞" T3⅞"
B2½" D3⅞"
Cs Pk 1 x 1 dz
Cs Wt 11.20 lb



Hi-Ball, 10 oz
Item #459085
Mfg. #15711 +
H6¼" T2¾"
B2" D2¾"
Cs Pk 1 x 1 dz
Cs Wt 10.80 lb



Beverage, 12 oz
Item #451127
Mfg. #15713 +
H6¼" T3"
B2¼" D3"
Cs Pk 1 x 1 dz
Cs Wt 12.30 lb



Beverage, 14 oz
Item #460569
Mfg. #15714 +
H6⅞" T3⅞"
B2¼" D3⅞"
Cs Pk 1 x 1 dz
Cs Wt 13.40 lb



Pub Glass, 16½ oz
Item #475965
Mfg. #15720 +
H6½" T3½"
B2½" D3½"
Cs Pk 1 x 1 dz
Cs Wt 14.30 lb



Cooler, 16 oz
Item #450509
Mfg. #15715 +
H7" T3¼"
B2⅞" D3¼"
Cs Pk 1 x 1 dz
Cs Wt 14.80 lb

DAKOTA®

LIBBEY®
+DuraTuff®



Beverage, 12 oz
Item #370270
Mfg. #15603 +
H4⅞" T3⅞"
B2⅞" D3⅞"
Cs Pk 1 x 3 dz
Cs Wt 36.00 lb



Cooler, 16 oz
Item #388100
Mfg. #15605 +
H6¼" T3½"
B2⅞" D3½"
Cs Pk 1 x 2 dz
Cs Wt 28.60 lb

PANELED TUMBLERS

LIBBEY®
+DuraTuff®

Libbey
GLASSWARE
A Libbey FOODSERVICE Company



Juice, 8½ oz
Item #370223
Mfg. #15640 +
H4⅞" T3"
B2¼" D3"
Cs Pk 1 x 3 dz
Cs Wt 20.70 lb



Tumbler, 12 oz
Item #370427
Mfg. #15641 +
H5⅞" T3⅞"
B2⅞" D3⅞"
Cs Pk 1 x 3 dz
Cs Wt 30.00 lb



Cooler, 16 oz
Item #370179
Mfg. #15642 +
H6⅞" T3⅞"
B2½" D3⅞"
Cs Pk 1 x 3 dz
Cs Wt 33.00 lb



Iced Tea, 20 oz
Item #369560
Mfg. #15643 +
H6⅞" T3⅞"
B2⅞" D3⅞"
Cs Pk 1 x 2 dz
Cs Wt 30.50 lb

EVEREST

LIBBEY®
+DuraTuff®



Juice, 5 oz
Item #370086
Mfg. #15431 +
H2⅞" T2⅞"
B1⅞" D2⅞"
Cs Pk 1 x 3 dz
Cs Wt 18.00 lb



Rocks, 7 oz
Item #370425
Mfg. #15432 +
H3⅞" T3"
B2½" D3"
Cs Pk 1 x 3 dz
Cs Wt 18.00 lb

EVEREST



Rocks, 8 oz
Item #370381
Mfg. #15433 +
H3 1/8" T3 1/8"
B2 1/8" D3 1/8"
Cs Pk 1 x 3 dz
Cs Wt 18.00 lb



Rocks, 9 oz
Item #369429
Mfg. #15434 +
H3 3/8" T3 3/8"
B2 3/4" D3 3/8"
Cs Pk 1 x 3 dz
Cs Wt 24.00 lb



Rocks, 12 oz
Item #369674
Mfg. #15435 +
H3 3/4" T3 3/8"
B3" D3 3/8"
Cs Pk 1 x 3 dz
Cs Wt 30.00 lb



Hi-Ball, 9 oz
Item #371342
Mfg. #15430 +
H4 1/2" T3"
B1 7/8" D3"
Cs Pk 1 x 3 dz
Cs Wt 25.00 lb



Beverage, 12 oz
Item #369190
Mfg. #15436 +
H4 3/8" T3 1/8"
B2 5/8" D3 1/8"
Cs Pk 1 x 3 dz
Cs Wt 25.80 lb



Cooler, 14 oz
Item #369225
Mfg. #15437 +
H4 3/4" T3 3/8"
B2 3/4" D3 3/8"
Cs Pk 1 x 3 dz
Cs Wt 28.00 lb

HEAVY BASE



Rocks, 8 oz
Item #369405
Mfg. #916CD ▲●
H3 1/4" T3"
B2 5/8" D3"
Cs Pk 1 x 3 dz
Cs Wt 21.00 lb



Beverage, 11 oz
Item #371312
Mfg. #917CD ▲●
H3 1/2" T3 1/4"
B3 1/8" D3 1/4"
Cs Pk 1 x 3 dz
Cs Wt 25.50 lb



Beverage, 12 1/2 oz
Item #370389
Mfg. #814CD ▲●
H5 5/8" T2 5/8"
B2 1/2" D2 5/8"
Cs Pk 1 x 3 dz
Cs Wt 24.00 lb



Cooler, 15 oz
Item #370366
Mfg. #817CD ▲●
H6 1/4" T3"
B2 1/2" D3"
Cs Pk 1 x 3 dz
Cs Wt 27.00 lb

HEAVY BASE



Old Fashioned, 5 1/2 oz
Item #370318
Mfg. #124 ●
H2 7/8" T2 7/8"
B2 1/8" D2 7/8"
Cs Pk 1 x 6 dz
Cs Wt 29.20 lb



Old Fashioned, 6 1/2 oz
Item #446314
Mfg. #127 ●
H3 1/4" T3"
B2 1/8" D3"
Cs Pk 1 x 4 dz
Cs Wt 21.15 lb



Old Fashioned, 9 oz
Item #388689
Mfg. #128 ●
H3 1/4" T3 3/8"
B2 3/8" D3 3/8"
Cs Pk 1 x 3 dz
Cs Wt 21.40 lb



English Hi-Ball, 13 oz
Item #369661
Mfg. #139 ●
H4" T3 3/8"
B2 3/4" D3 3/8"
Cs Pk 1 x 4 dz
Cs Wt 35.00 lb



English Hi-Ball, 14 1/4 oz
Item #370868
Mfg. #170 ●
H4 3/8" T3 3/8"
B2 3/4" D3 3/8"
Cs Pk 1 x 4 dz
Cs Wt 35.00 lb



Split, 6 oz
Item #370505
Mfg. #151 ●
H4" T2 5/8"
B2 1/8" D2 5/8"
Cs Pk 1 x 6 dz
Cs Wt 33.00 lb



Hi-Ball, 7 oz
Item #455745
Mfg. #123 ●
H4 3/8" T2 1/2"
B2 1/8" D2 1/2"
Cs Pk 1 x 4 dz
Cs Wt 19.70 lb



Hi-Ball, 8 oz
Item #457012
Mfg. #132 ●
H4 3/8" T2 5/8"
B2 1/8" D2 5/8"
Cs Pk 1 x 4 dz
Cs Wt 23.70 lb



Hi-Ball, 9 oz
Item #456252
Mfg. #125 ●
H4 3/4" T2 3/4"
B2 1/4" D2 3/4"
Cs Pk 1 x 4 dz
Cs Wt 26.40 lb



Hi-Ball, 9 oz
Item #388107
Mfg. #133 ●
H5" T2 3/4"
B2" D2 3/4"
Cs Pk 1 x 3 dz
Cs Wt 20.80 lb



Hi-Ball, 10 1/2 oz
Item #455753
Mfg. #172 ●
H5 1/8" T2 3/4"
B2 3/8" D2 7/8"
Cs Pk 1 x 4 dz
Cs Wt 28.70 lb



Hi-Ball, 10 1/2 oz
Item #370596
Mfg. #161 ●
H5 1/4" T2 1/4"
B2 1/2" D2 1/2"
Cs Pk 1 x 4 dz
Cs Wt 31.00 lb



Collins, 11 oz
Item #388102
Mfg. #126 ●
H5 1/4" T2 5/8"
B2 3/8" D2 7/8"
Cs Pk 1 x 3 dz
Cs Wt 20.90 lb



Beverage, 12 1/2 oz
Item #456253
Mfg. #159 ●
H5 5/8" T2 7/8"
B2 1/2" D2 7/8"
Cs Pk 1 x 4 dz
Cs Wt 33.90 lb



Cooler, 20 oz
Item #370618
Mfg. #158 ●
H6 1/4" T3 3/8"
B2 3/4" D3 3/8"
Cs Pk 1 x 1 dz
Cs Wt 10.00 lb

SUPER SHAM



Rocks, 7 oz
Item #370135
Mfg. #1654SR ✕
H3³/₈" T2⁷/₈"
B2³/₄" D2⁷/₈"
Cs Pk 1 x 2 dz
Cs Wt 16.00 lb



Rocks, 10¹/₂ oz
Item #370225
Mfg. #1660SR ✕
H4¹/₈" T3¹/₈"
B2⁷/₈" D3¹/₈"
Cs Pk 1 x 2 dz
Cs Wt 19.00 lb



Beverage, 12 oz
Item #370145
Mfg. #1661SR ✕
H6⁵/₈" T2¹/₂"
B2¹/₄" D2¹/₂"
Cs Pk 1 x 2 dz
Cs Wt 17.00 lb



NOB HILL®



Old Fashioned,
7¹/₄ oz
Item #458820
Mfg. #23286 ●
H3¹/₂" T2³/₄"
B2³/₄" D2⁷/₈"
Cs Pk 1 x 4 dz
Cs Wt 25.20 lb



Old Fashioned,
10¹/₄ oz
Item #455335
Mfg. #23386 ●
H3³/₈" T3¹/₄"
B3¹/₈" D3¹/₄"
Cs Pk 1 x 2 dz
Cs Wt 17.45 lb



Double Old Fashioned,
12¹/₄ oz
Item #370399
Mfg. #23396 ●
H3³/₈" T3¹/₈"
B3¹/₈" D3¹/₄"
Cs Pk 1 x 3 dz
Cs Wt 27.45 lb



Hi-Ball, 6³/₄ oz
Item #449713
Mfg. #23236 ●
H4¹/₈" T2³/₈"
B2³/₈" D2¹/₂"
Cs Pk 1 x 4 dz
Cs Wt 28.10 lb



Hi-Ball, 8 oz
Item #452023
Mfg. #23186 ●
H4¹/₂" T2³/₈"
B2³/₈" D2¹/₂"
Cs Pk 1 x 4 dz
Cs Wt 23.70 lb



Hi-Ball, 9 oz
Item #454343
Mfg. #23256 ●
H4⁵/₈" T2¹/₂"
B2¹/₂" D2³/₈"
Cs Pk 1 x 4 dz
Cs Wt 31.10 lb



Beverage, 11¹/₄ oz
Item #455405
Mfg. #23596 ●
H5" T2³/₄"
B2³/₄" D2³/₄"
Cs Pk 1 x 2 dz
Cs Wt 16.20 lb



Tall Hi-Ball, 10¹/₂ oz
Item #386805
Mfg. #23106 ●
H6" T2¹/₂"
B2¹/₄" D2¹/₂"
Cs Pk 1 x 3 dz
Cs Wt 23.90 lb



ESQUIRE



Old Fashioned, 7¹/₄ oz
Item #370342
Mfg. #227 ●
H3¹/₄" T3"
B2¹/₂" D3¹/₈"
Cs Pk 1 x 6 dz
Cs Wt 32.00 lb



Split, 7 oz
Item #444512
Mfg. #223 ●
H4⁵/₈" T2³/₈"
B2¹/₄" D2³/₈"
Cs Pk 1 x 4 dz
Cs Wt 21.90 lb



Hi-Ball, 8 oz
Item #456251
Mfg. #232 ●
H4⁷/₈" T2³/₈"
B2³/₈" D2¹/₂"
Cs Pk 1 x 4 dz
Cs Wt 24.00 lb



Hi-Ball, 9¹/₄ oz
Item #388103
Mfg. #225 ●
H5" T2¹/₂"
B2¹/₂" D2³/₈"
Cs Pk 1 x 3 dz
Cs Wt 21.70 lb



Collins, 11 oz
Item #388109
Mfg. #226 ●
H5³/₈" T2³/₈"
B2³/₈" D2³/₄"
Cs Pk 1 x 3 dz
Cs Wt 24.80 lb



Collins, 12¹/₄ oz
Item #388104
Mfg. #259 ●
H5¹/₂" T2³/₈"
B2³/₈" D2⁷/₈"
Cs Pk 1 x 3 dz
Cs Wt 24.90 lb

IMPRESSIONS



Double Old Fashioned,
11¹/₄ oz
Item #376565
Mfg. #1767591
H4" T3³/₈" B3³/₈" D3³/₈"
Cs Pk 1 x 1 dz
Cs Wt 9.60 lb



Beverage, 13 oz
Item #369549
Mfg. #9860594
H5¹/₂" T3"
B3" D3"
Cs Pk 1 x 1 dz
Cs Wt 10.00 lb

ROOM TUMBLERS



Room Tumbler, 8 oz
Item #465016
Mfg. #135 ●
H3³/₈" T2³/₄"
B2³/₈" D2³/₄"
Cs Pk 1 x 4 dz
Cs Wt 22.50 lb



Beverage, 11 oz
Item #369221
Mfg. #9171CD ▲
H3¹/₂" T3¹/₄"
B3¹/₈" D3¹/₄"
Cs Pk 1 x 3 dz
Cs Wt 26.00 lb

MISCELLANEOUS TUMBLERS



Old Fashioned, 4 oz
Item #453590
Mfg. #5131
H3¹/₈" T2⁷/₈"
B2¹/₄" D2⁷/₈"
Cs Pk 1 x 4 dz
Cs Wt 32.60 lb



Old Fashioned, 5 oz
Item #369574
Mfg. #5130
H3¹/₈" T2⁷/₈"
B2¹/₄" D2⁷/₈"
Cs Pk 1 x 3 dz
Cs Wt 19.00 lb

STRAIGHT SIDED



LIBBEY®
★ HEAT TREATED



Hi-Ball, 8 oz
Item #372485
Mfg. #44 ●
H4 3/4" T2 3/8"
B2 1/8" D2 3/8"
Cs Pk 1 x 6 dz
Cs Wt 26.00 lb



Collins, 10 oz
Item #369271
Mfg. #53 ●
H4 3/4" T2 3/8"
B2 1/4" D2 3/4"
Cs Pk 1 x 6 dz
Cs Wt 29.00 lb



Zombie, 12 oz
Item #369357
Mfg. #96 ●
H6" T2 1/2"
B2 1/4" D2 1/2"
Cs Pk 1 x 6 dz
Cs Wt 32.00 lb

BELL SODA



Bell Soda, 21 oz
Item #370438
Mfg. #539HT ★●
H6 1/2" T3 3/8"
B2 3/8" D3 3/4"
Cs Pk 1 x 3 dz
Cs Wt 30.20 lb

SPECIALTY TUMBLERS



Cooler, 16 oz
Item #370352
Mfg. #32802
H6 3/4" T2 3/8"
B2 3/8" D2 7/8"
Cs Pk 1 x 3 dz
Cs Wt 22.00 lb



Cobalt Blue
Cooler, 17 1/4 oz
Item #370390
Mfg. #171B
H5 3/8" T3 1/2" B2 3/8" D3 1/2"
Cs Pk 1 x 1 dz
Cs Wt 9.40 lb

TABLETOP

FROSTED CLEAR LIP



Collins, 10 oz
Item #442295
Mfg. #53/11680 ●
H4 3/4" T2 3/4"
B2 1/8" D2 3/4"
Cs Pk 1 x 4 dz
Cs Wt 17.50 lb



Zombie, 12 oz
Item #440835
Mfg. #96/11680 ●
H6" T2 1/2"
B2 1/4" D2 1/2"
Cs Pk 1 x 4 dz
Cs Wt 22.70 lb

FOOTED



LIBBEY®
★ HEAT TREATED

Libbey
GLASSWARE®
A Libbey FOODSERVICE Company



Beverage, 9 oz
Item #388111
Mfg. #1454HT ★●
H4 7/8" T2 3/4"
B2 3/8" D2 3/4"
Cs Pk 1 x 3 dz
Cs Wt 20.80 lb



Malted, 10 oz
Item #370475
Mfg. #1451HT ★●
H5 1/4" T2 3/4"
B2 3/8" D2 3/8"
Cs Pk 1 x 3 dz
Cs Wt 21.60 lb



Soda, 12 1/4 oz
Item #428901
Mfg. #1453HT ★●
H5 1/2" T3"
B2 1/2" D3"
Cs Pk 1 x 3 dz
Cs Wt 24.60 lb

GOVERNOR CLINTON®



LIBBEY®
★ HEAT TREATED

Libbey
GLASSWARE®
A Libbey FOODSERVICE Company



Juice, 5 oz
Item #369425
Mfg. #633HT ★●
H3 3/4" T2 1/8"
B1 3/4" D2 1/4"
Cs Pk 1 x 6 dz
Cs Wt 17.00 lb



Beverage, 8 oz
Item #447746
Mfg. #618HT ★●
H3 3/8" T2 3/8"
B2 3/8" D2 3/4"
Cs Pk 1 x 4 dz
Cs Wt 17.50 lb



Water, 9 1/2 oz
Item #369489
Mfg. #610HT ★●
H3 7/8" T2 3/8"
B2 1/2" D2 7/8"
Cs Pk 1 x 6 dz
Cs Wt 27.00 lb



Iced Tea, 12 oz
Item #452224
Mfg. #606HT ★●
H5 1/2" T2 1/2"
B2 3/8" D2 3/8"
Cs Pk 1 x 4 dz
Cs Wt 21.90 lb



Soda, 15 1/2 oz
Item #388099
Mfg. #1713HT ★●
H6 3/8" T3"
B2 1/2" D3 1/4"
Cs Pk 1 x 3 dz
Cs Wt 20.10 lb

CASCADE



LIBBEY®
★ HEAT TREATED



Juice/Side Water, 6 oz
Item #369364
Mfg. #29011HT ★●
H3½" T2⅝"
B2⅝" D2½"
Cs Pk 1 x 6 dz
Cs Wt 27.00 lb



Beverage, 8 oz
Item #463668
Mfg. #29511HT ★●
H3¾" T2¾"
B2⅝" D2¾"
Cs Pk 1 x 4 dz
Cs Wt 24.20 lb



Water, 10 oz
Item #369347
Mfg. #29211HT ★●
H4¼" T2¾"
B2¾" D2⅞"
Cs Pk 1 x 6 dz
Cs Wt 40.30 lb



Beverage, 12 oz
Item #458822
Mfg. #29411HT ★●
H5⅝" T2¾"
B2⅝" D2¾"
Cs Pk 1 x 2 dz
Cs Wt 15.50 lb



Cooler, 16 oz
Item #460213
Mfg. #29811HT ★●
H6" T2⅞"
B2⅝" D3"
Cs Pk 1 x 2 dz
Cs Wt 18.20 lb



NO-NIK



LIBBEY®
★ HEAT TREATED



Beverage, 7¾ oz
Item #369476
Mfg. #1917HT ★●
H3¾" T2½"
B2⅝" D2⅝"
Cs Pk 1 x 6 dz
Cs Wt 24.00 lb



Water, 10 oz
Item #458817
Mfg. #1910HT ★●
H3⅝" T2¾"
B2⅝" D2⅞"
Cs Pk 1 x 4 dz
Cs Wt 15.30 lb



Iced Tea, 12 oz
Item #369209
Mfg. #1906HT ★●
H5⅝" T2⅝"
B2½" D2¾"
Cs Pk 1 x 6 dz
Cs Wt 28.00 lb

RESTAURANT BASICS®

LIBBEY®
+DuraTuff®



Hi-Ball, 9 oz
Item #411731
Mfg. #15585 +
H4½" T3⅝"
B2⅝" D3⅝"
Cs Pk 1 x 2 dz
Cs Wt 17.20 lb



Beverage, 12 oz
Item #411733
Mfg. #15588 +
H5" T3⅝"
B2⅝" D3¼"
Cs Pk 1 x 2 dz
Cs Wt 19.10 lb



Libbey
GLASSWARE
A Libbey FOODSERVICE Company



Cooler, 14 oz
Item #387219
Mfg. #15141 +
H5⅝" T3½"
B2⅝" D3½"
Cs Pk 1 x 2 dz
Cs Wt 30.70 lb



Mixing Glass, 16 oz
Item #369193
Mfg. #1639HT +
H5⅝" T3½"
B2⅝" D3½"
Cs Pk 1 x 2 dz
Cs Wt 23.60 lb



Mixing Glass, 16 oz
Item #385622
Mfg. #5139 +
H5⅝" T3½"
B2⅝" D3½"
Cs Pk 1 x 2 dz
Cs Wt 23.60 lb



Mixing Glass, 20 oz
Item #369678
Mfg. #1637HT +
H6⅝" T3¾"
B2½" D3¾"
Cs Pk 1 x 2 dz
Cs Wt 31.00 lb



Mixing Glass, 20 oz
Item #370311
Mfg. #5137 +
H6⅝" T3¾"
B2½" D3¾"
Cs Pk 1 x 2 dz
Cs Wt 31.00 lb



Cooler, 22 oz
Item #437931
Mfg. #15722 +
H7" T3⅝"
B2½" D3⅝"
Cs Pk 1 x 2 dz
Cs Wt 36.50 lb

WHISKEY SERVICE

Libbey
GLASSWARE
A Libbey FOODSERVICE Company

TABLETOP



Tall Whiskey, 3/4 oz
Item #370396
Mfg. #5030
H2 7/8" T1 3/4"
B1 1/4" D1 3/4"
Cs Pk 1 x 6 dz
Cs Wt 23.65 lb



Tall Whiskey, 1 oz
Item #370181
Mfg. #5031
H2 7/8" T1 3/4"
B1 1/4" D1 3/4"
Cs Pk 1 x 6 dz
Cs Wt 21.00 lb



Tall Whiskey, 1 oz
Item #370178
Mfg. #5138
H3" T2 1/4"
B1 3/4" D2 1/4"
Cs Pk 1 x 4 dz
Cs Wt 31.00 lb



Whiskey, 7/8 oz
Item #370107
Mfg. #5128
H2 3/8" T2"
B1 5/8" D2"
Cs Pk 1 x 1 dz
Cs Wt 22.00 lb



Whiskey, 1 oz
Item #369443
Mfg. #5122
H2 3/8" T2"
B1 3/8" D2"
Cs Pk 1 x 6 dz
Cs Wt 23.00 lb



Whiskey, 1 1/4 oz
Item #370337
Mfg. #5121
H2 3/8" T2"
B1 3/8" D2"
Cs Pk 1 x 6 dz
Cs Wt 20.00 lb



Whiskey, 1 1/2 oz
Item #370458
Mfg. #5120
H2 3/8" T2"
B1 3/8" D2"
Cs Pk 1 x 6 dz
Cs Wt 17.00 lb



Whiskey, 2 oz
Item #369579
Mfg. #48
H2 3/8" T2"
B1 1/2" D2"
Cs Pk 1 x 6 dz
Cs Wt 17.00 lb



Whiskey, 3 oz
Item #370260
Mfg. #2303 ●
H2 3/8" T2"
B2" D2"
Cs Pk 1 x 3 dz
Cs Wt 10.00 lb



1 oz, Lined 3/8 oz
Item #369350
Mfg. #5122S0709
H2 3/8" T2"
B1 3/8" D2"
Cs Pk 1 x 6 dz
Cs Wt 23.00 lb



1 1/4 oz, Lined 1/2 oz
Item #370191
Mfg. #5135SO617
H2 3/8" T2 1/4"
B1 3/4" D2 1/4"
Cs Pk 1 x 4 dz
Cs Wt 29.00 lb



1 1/4 oz, Lined 7/8 oz
Item #370134
Mfg. #5121S0711
H2 3/8" T2"
B1 3/8" D2"
Cs Pk 1 x 6 dz
Cs Wt 20.00 lb



1 1/2 oz, Lined 3/4 oz
Item #371205
Mfg. #5127S0710
H2 3/8" T2 1/4"
B1 3/4" D2 1/4"
Cs Pk 1 x 4 dz
Cs Wt 28.00 lb



1 1/2 oz, Lined 7/8 oz
Item #369337
Mfg. #5127S0711
H2 3/8" T2 1/4"
B1 3/4" D2 1/4"
Cs Pk 1 x 4 dz
Cs Wt 28.00 lb



1 1/2 oz, Lined 1 oz
Item #370232
Mfg. #5120A0007
H2 3/8" T2"
B1 3/8" D2"
Cs Pk 1 x 6 dz
Cs Wt 17.00 lb



2 oz, Lined 7/8 oz
Item #370205
Mfg. #5126S0711
H2 3/8" T2 1/4"
B1 3/4" D2 1/4"
Cs Pk 1 x 4 dz
Cs Wt 24.00 lb



2 oz, Lined 1 oz
Item #369545
Mfg. #5126A0007
H2 3/8" T2 1/4"
B1 3/4" D2 1/4"
Cs Pk 1 x 4 dz
Cs Wt 24.00 lb



Fluted, 1 1/4 oz
Item #370284
Mfg. #5135
H2 3/8" T2 1/4"
B1 3/4" D2 1/4"
Cs Pk 1 x 4 dz
Cs Wt 29.00 lb

Libbey
GLASSWARE
A Libbey FOODSERVICE Company

SPECIALTY SHOTS & SHOOTERS



Fluted, 1 1/2 oz
Item #371204
Mfg. #5127
H2 3/8" T2 1/4"
B1 3/4" D2 1/4"
Cs Pk 1 x 4 dz
Cs Wt 28.00 lb



Fluted, 2 oz
Item #370343
Mfg. #5126
H2 3/8" T2 1/4"
B1 3/4" D2 1/4"
Cs Pk 1 x 4 dz
Cs Wt 24.00 lb



Mini-Martini, 3 oz
Item #433733
Mfg. #3701 ■
H3 3/4" T3 3/8"
B2 1/8" D3 3/8"
Cs Pk 1 x 1 dz
Cs Wt 3.80 lb



Tequila Shooter, 1 1/2 oz
Item #377096
Mfg. #9862324
H3 3/8" T1 1/2"
B1 1/4" D1 1/2"
Cs Pk 1 x 6 dz
Cs Wt 16.10 lb



Cordial, 2 1/2 oz
Item #370228
Mfg. #1650SR ✱
H4 1/8" T1 1/2"
B1 3/8" D1 1/2"
Cs Pk 1 x 2 dz
Cs Wt 6.00 lb



Spirit Glass, 1 3/4 oz
Item #370511
Mfg. #155
H4 1/8" T2"
B1 1/2" D2"
Cs Pk 1 x 2 dz
Cs Wt 9.00 lb

SPECIALTY SHOTS & SHOOTERS



Shooter, 1 7/8 oz
Item #370248
 Mfg. #5109
 H3 1/2" T2"
 B1 1/8" D2"
 Cs Pk 1 x 2 dz
 Cs Wt 7.00 lb



Boot Shot, 1 1/2 oz
Item #370120
 Mfg. #97038
 H3 1/8" T1 1/8"
 B2 1/8" D2 3/4"
 Cs Pk 1 x 3 dz
 Cs Wt 9.00 lb



Troyano Shooter, 5 3/8 oz
Item #429127
 Mfg. #1787386
 H5 5/8" T2 3/8"
 B1 7/8" D2 3/8"
 Cs Pk 1 x 2 dz
 Cs Wt 21.00 lb

HEAVY BASE PILSNERS



Pilsner, 7 oz
Item #372438
 Mfg. #15 ●
 H5 1/4" T2 5/8"
 B2 1/4" D2 7/8"
 Cs Pk 1 x 6 dz
 Cs Wt 38.00 lb



Pilsner, 10 oz
Item #399411
 Mfg. #13 ●
Item #412614
 Mfg. #1013HT ★●
 H5 7/8" T2 3/4"
 B2 1/2" D3"
 Cs Pk 1 x 3 dz
 Cs Wt 23.90 lb



Pilsner, 12 oz
Item #388101
 Mfg. #14 ●
 H6 1/4" T2 7/8"
 B2 1/2" D3 1/8"
 Cs Pk 1 x 3 dz
 Cs Wt 27.00 lb

HOURGLASS PILSNERS



LIBBEY®
 ★ HEAT TREATED

Libbey
 GLASSWARE
 A Libbey FOODSERVICE Company



Pilsner, 9 oz
Item #370161
 Mfg. #176 ●
Item #370564
 Mfg. #1176HT ★●
 H5 3/8" T2 3/4"
 B2 3/8" D2 7/8"
 Cs Pk 1 x 3 dz
 Cs Wt 23.00 lb



Pilsner, 10 oz
Item #451267
 Mfg. #178 ●
Item #452022
 Mfg. #1178HT ★●
 H5 3/4" T2 3/4"
 B2 3/8" D2 3/4"
 Cs Pk 1 x 2 dz
 Cs Wt 15.40 lb



Pilsner, 11 oz
Item #402449
 Mfg. #179 ●
 H6" T2 3/4"
 B2 3/8" D2 7/8"
 Cs Pk 1 x 3 dz
 Cs Wt 23.00 lb



Pilsner, 12 oz
Item #452922
 Mfg. #181 ●
Item #452226
 Mfg. #1181HT ★●
 H6" T3 1/8"
 B2 3/8" D3 1/4"
 Cs Pk 1 x 2 dz
 Cs Wt 17.10 lb



Libbey
 GLASSWARE
 A Libbey FOODSERVICE Company



Pilsner, 15 oz
Item #370210
 Mfg. #183 ●
Item #370457
 Mfg. #1183HT ★●
 H6 3/8" T3 1/4"
 B2 3/8" D3 1/4"
 Cs Pk 1 x 3 dz
 Cs Wt 29.00 lb



FLARE PILSNERS



Flare Pilsner, 10 oz
Item #388110
 Mfg. #1240HT ★●
 H6 3/4" T3"
 B2 1/8" D3 1/8"
 Cs Pk 1 x 3 dz
 Cs Wt 21.90 lb



Flare Pilsner, 11 oz
Item #370542
 Mfg. #18 ●
 H7" T3 1/8"
 B2 1/2" D3 1/8"
 Cs Pk 1 x 3 dz
 Cs Wt 29.00 lb



Pilsner, 11 1/2 oz
Item #369375
 Mfg. #19 ●
 H7 1/4" T3 1/8"
 B2 1/2" D3 1/4"
 Cs Pk 1 x 3 dz
 Cs Wt 30.00 lb

FLARE PILSNERS



Pilsner, 19¼ oz
Item #419542
Mfg. #1242HT ★●
H8" T3⅞"
B2⅞" D3⅞"
Cs Pk 1 x 1 dz
Cs Wt 12.70 lb



Pilsner, 16 oz
Item #488384
Mfg. #247 ●
H8⅞" T3½"
B2⅝" D3½"
Cs Pk 1 x 1 dz
Cs Wt 12.80 lb

INTERNATIONAL STYLE BEERS



Giant Beer, 23 oz
Item #386504
Mfg. #1611 ●
H8⅞" T3"
B3⅞" D3⅝"
Cs Pk 1 x 1 dz
Cs Wt 14.50 lb



Giant Beer, 23 oz
Item #406181
Mfg. #1623 ●
H9¼" T3⅝"
B3⅞" D3⅝"
Cs Pk 1 x 1 dz
Cs Wt 13.10 lb



Giant Beer, 23 oz
Item #368644
Mfg. #1610 ●
H9¼" T3½"
B2¾" D3½"
Cs Pk 1 x 1 dz
Cs Wt 12.75 lb



Giant Beer, 22¾ oz
Item #370881
Mfg. #2478 ●
H9⅞" T3¼"
B3⅞" D3⅝"
Cs Pk 1 x 1 dz
Cs Wt 16.00 lb



Pilsner, 16 oz
Item #480549
Mfg. #1604 ●
H8⅞" T3"
B2⅝" D3"
Cs Pk 1 x 2 dz
Cs Wt 22.20 lb



Pub Glass, 16 oz
Item #370216
Mfg. #194 ●
H6⅞" T3⅞"
B2½" D3"
Cs Pk 1 x 3 dz
Cs Wt 28.00 lb



Pub Glass, 16 oz
Item #370174
Mfg. #14806HT ★●
H6" T3⅞"
B2¼" D3¼"
Cs Pk 1 x 3 dz
Cs Wt 24.00 lb



Pub Glass, 20 oz
Item #369220
Mfg. #14801HT ★●
H6" T3⅞"
B2⅝" D3½"
Cs Pk 1 x 3 dz
Cs Wt 29.40 lb



Pub Glass, 20 oz
Item #447742
Mfg. #4803 ●
H6⅞" T3⅞"
B2⅝" D3⅞"
Cs Pk 1 x 2 dz
Cs Wt 15.50 lb



BEVERAGE & BEER



Casual Cooler
Waves, 20 oz
Item #426122
Mfg. #15646 +
H6¾" T3⅞"
B2½" D3⅞"
Cs Pk 1 x 1 dz
Cs Wt 14.70 lb



FOOTED BEERS



Hoffman House Goblet, 10 oz
Item #369497
Mfg. #5210
H6⅞" T4"
B3¼" D4"
Cs Pk 1 x 1 dz
Cs Wt 24.00 lb



Hoffman House Goblet, 12 oz
Item #369570
Mfg. #5212
H6⅞" T4"
B3¼" D4"
Cs Pk 1 x 1 dz
Cs Wt 21.00 lb



Schooner, 18 oz
Item #375984
Mfg. #1785473
H7¼" T4½"
B4¼" D4¾"
Cs Pk 1 x 1 dz
Cs Wt 32.41 lb



Schooner, 21 oz
Item #371399
Mfg. #1722471
H7¼" T4½"
B4¼" D4¾"
Cs Pk 1 x 1 dz
Cs Wt 27.00 lb



Pilsner, 10 oz
Item #369650
Mfg. #6425 ●
H8⅞" T2⅞"
B2¾" D2⅞"
Cs Pk 1 x 2 dz
Cs Wt 16.00 lb

● Safedge® Rim Guarantee ★ Heat-Treated + DuraTuff®

Sold in case pack only.

FOOTED BEERS



Footed Ale, 10 oz
Item #369540
Mfg. #3810 ■
H6½" T2½"
B2¾" D2¾"
Cs Pk 1 x 3 dz
Cs Wt 23.00 lb



Footed Ale, 12 oz
Item #370269
Mfg. #3812 ■
H6½" T2¾"
B2¾" D3"
Cs Pk 1 x 3 dz
Cs Wt 22.50 lb



Footed Ale, 15¼ oz
Item #370281
Mfg. #3815 ■
H8¾" T2½"
B3" D3¼"
Cs Pk 1 x 2 dz
Cs Wt 23.40 lb

MUGS & TANKARDS



Mug, 22 oz
Item #373236
Mfg. #5360
H8" T3⅞"
B3¼" D5⅞"
Cs Pk 1 x 1 dz
Cs Wt 28.70 lb



Handled Mug, 15 oz
Item #370180
Mfg. #5011
H5½" T3"
B3⅞" D4½"
Cs Pk 1 x 1 dz
Cs Wt 17.00 lb



Mug, 8½ oz
Item #369669
Mfg. #5307
H5⅝" T2⅞"
B2¾" D4⅞"
Cs Pk 1 x 2 dz
Cs Wt 36.00 lb



Mug, 12 oz
Item #369218
Mfg. #5309
H5⅝" T3"
B2⅞" D4⅞"
Cs Pk 1 x 2 dz
Cs Wt 40.10 lb



Mug, 10 oz
Item #387220
Mfg. #5362
H5¾" T3⅞"
B3" D4¾"
Cs Pk 1 x 1 dz
Cs Wt 23.30 lb



Mug, 12 oz
Item #381932
Mfg. #5364
H5½" T3¼"
B3¼" D5⅞"
Cs Pk 1 x 1 dz
Cs Wt 23.90 lb



Scandinavia Mug, 12 oz
Item #369359
Mfg. #5297
H5⅝" T3⅞"
B3⅞" D4⅞"
Cs Pk 1 x 1 dz
Cs Wt 20.00 lb



Scandinavia, 15 oz
Item #369343
Mfg. #5298
H6¼" T3⅞"
B3½" D5⅞"
Cs Pk 1 x 1 dz
Cs Wt 24.00 lb



Stein, 10 oz
Item #368808
Mfg. #5205
H5⅝" T2⅞"
B3¼" D4½"
Cs Pk 1 x 1 dz
Cs Wt 26.00 lb



Handled Mug, 12½ oz
Item #369519
Mfg. #5012
H5½" T2⅞"
B2⅞" D4½"
Cs Pk 1 x 2 dz
Cs Wt 32.00 lb



Mug, 10 oz
Item #369217
Mfg. #5202
H5⅝" T3⅞"
B2½" D5⅞"
Cs Pk 1 x 2 dz
Cs Wt 28.00 lb



Mug, 11 oz
Item #369228
Mfg. #5203
H5⅝" T3⅞"
B2¾" D5¼"
Cs Pk 1 x 2 dz
Cs Wt 26.00 lb

■ Safedge® Rim and Foot Guarantee

Sold in case pack only.

MUGS & TANKARDS

Libbey
GLASSWARE
A Libbey FOODSERVICE Company

TABLETOP



Tankard, 16 oz
Item #369389
Mfg. #5092
H6 $\frac{1}{8}$ " T3 $\frac{1}{8}$ "
B3 $\frac{3}{8}$ " D4 $\frac{3}{4}$ "
Cs Pk 1 x 1 dz
Cs Wt 21.00 lb



Dimple Stein, 19 $\frac{1}{4}$ oz
Item #370587
Mfg. #5355
H4 $\frac{7}{8}$ " T3 $\frac{3}{8}$ "
B2 $\frac{3}{4}$ " D5 $\frac{1}{8}$ "
Cs Pk 1 x 2 dz
Cs Wt 33.00 lb



Handled Mug, 12 oz
Item #369393
Mfg. #5010
H5 $\frac{1}{8}$ " T3 $\frac{3}{8}$ "
B3 $\frac{1}{8}$ " D4 $\frac{1}{2}$ "
Cs Pk 1 x 2 dz
Cs Wt 41.00 lb



Paneled Mug, 10 oz
Item #369529
Mfg. #5019
H5 $\frac{5}{8}$ " T3 $\frac{1}{4}$ "
B3 $\frac{1}{4}$ " D4 $\frac{7}{8}$ "
Cs Pk 1 x 1 dz
Cs Wt 25.00 lb



Paneled Mug, 12 oz
Item #370603
Mfg. #5021
H5 $\frac{5}{8}$ " T3 $\frac{1}{4}$ "
B3 $\frac{1}{4}$ " D4 $\frac{7}{8}$ "
Cs Pk 1 x 1 dz
Cs Wt 20.00 lb



Paneled Mug, 12 oz
Item #370582
Mfg. #5016
H5 $\frac{7}{8}$ " T3 $\frac{3}{8}$ "
B3 $\frac{1}{4}$ " D5 $\frac{1}{8}$ "
Cs Pk 1 x 1 dz
Cs Wt 27.00 lb



Paneled Mug, 14 oz
Item #369610
Mfg. #5018
H6 $\frac{1}{8}$ " T3 $\frac{1}{2}$ "
B3 $\frac{1}{2}$ " D5"
Cs Pk 1 x 1 dz
Cs Wt 30.00 lb



Paneled Mug, 16 oz
Item #369154
Mfg. #5020
H6 $\frac{1}{8}$ " T3 $\frac{1}{2}$ "
B3 $\frac{1}{2}$ " D5"
Cs Pk 1 x 1 dz
Cs Wt 27.00 lb



Maritime Mug, 15 oz
Item #382015
Mfg. #5027
H5 $\frac{1}{8}$ " T3 $\frac{1}{4}$ "
B3 $\frac{3}{4}$ " D5"
Cs Pk 1 x 1 dz
Cs Wt 21.00 lb



Stein, 12 oz
Item #368692
Mfg. #5206
H5 $\frac{5}{8}$ " T2 $\frac{5}{8}$ "
B3 $\frac{1}{4}$ " D4 $\frac{1}{2}$ "
Cs Pk 1 x 1 dz
Cs Wt 23.00 lb



Mug, 12 oz
Item #370249
Mfg. #5273
H5 $\frac{1}{2}$ " T2 $\frac{3}{4}$ "
B2 $\frac{3}{4}$ " D4 $\frac{1}{8}$ "
Cs Pk 1 x 1 dz
Cs Wt 16.00 lb



Sport Mug, 25 oz
Item #369161
Mfg. #5272
H7 $\frac{1}{8}$ " T3 $\frac{3}{8}$ "
B3 $\frac{3}{8}$ " D5 $\frac{1}{8}$ "
Cs Pk 1 x 1 dz
Cs Wt 34.00 lb



Super Mug, 34 oz
Item #369447
Mfg. #5262
H8" T4"
B4" D6"
Cs Pk 1 x 1 dz
Cs Wt 39.00 lb



Frankfurt Mug, 20 $\frac{3}{4}$ oz
Item #369197
Mfg. #5001
H9" T3"
B3 $\frac{3}{8}$ " D4 $\frac{3}{8}$ "
Cs Pk 1 x 1 dz
Cs Wt 27.50 lb



Drinking Jar, 16 $\frac{1}{2}$ oz
Item #369422
Mfg. #97085
H5 $\frac{1}{4}$ " T2 $\frac{5}{8}$ "
B2 $\frac{1}{2}$ " D4 $\frac{1}{8}$ "
Cs Pk 1 x 1 dz
Cs Wt 12.00 lb



Drinking Jar, 16 $\frac{1}{2}$ oz
Item #369649
Mfg. #97084
H5 $\frac{1}{4}$ " T2 $\frac{5}{8}$ "
B2 $\frac{1}{2}$ " D4 $\frac{1}{8}$ "
Cs Pk 1 x 1 dz
Cs Wt 12.00 lb



Boot Mug, 17 oz
Item #370148
Mfg. #97036
H6 $\frac{1}{2}$ " T3 $\frac{1}{4}$ "
B3 $\frac{3}{8}$ " D5 $\frac{1}{8}$ "
Cs Pk 1 x 1 dz
Cs Wt 17.00 lb

Libbey
GLASSWARE
A Libbey FOODSERVICE Company

Sold in case pack only.

WARM BEVERAGE

TABLETOP



Warm Beverage, 10 oz
Item #369456
Mfg. #5201
H3½" T3½"
B2¾" D4½"
Cs Pk 1 x 1 dz
Cs Wt 29.00 lb



Warm Beverage, 13 oz
Item #370291
Mfg. #5213
H3¾" T3½"
B3¾" D4¾"
Cs Pk 1 x 1 dz
Cs Wt 13.00 lb



Warm Beverage, 13 oz
Item #370443
Mfg. #5213B
H3¾" T3½"
B3¾" D4¾"
Cs Pk 1 x 1 dz
Cs Wt 13.00 lb



Catalina Irish Coffee, 8½ oz
Item #370250
Mfg. #5293
H5⅞" T3"
B2⅞" D3⅞"
Cs Pk 1 x 2 dz
Cs Wt 21.00 lb



Irish Coffee, 10½ oz
Item #370538
Mfg. #5304
H5" T3⅞"
B2¾" D4¼"
Cs Pk 1 x 1 dz
Cs Wt 12.00 lb



Irish Coffee w/Optic, 8¼ oz
Item #369181
Mfg. #5294
H5⅞" T3⅞"
B2¾" D4⅞"
Cs Pk 1 x 2 dz
Cs Wt 22.00 lb



Irish Coffee, 8½ oz
Item #368655
Mfg. #5295
H5⅞" T3⅞"
B2¾" D4⅞"
Cs Pk 1 x 2 dz
Cs Wt 21.00 lb



HARMONY



Salad Plate, 7⅝"
Item #369517
Mfg. #15506 +
H7⅞" T7⅞"
B5½" D7⅞"
Cs Pk 1 x 3 dz
Cs Wt 29.00 lb

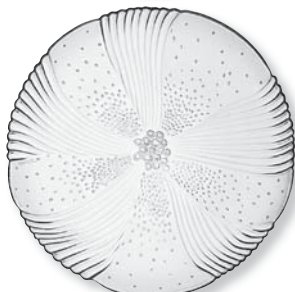

Soup/Salad Plate,
8", 24 oz
Item #370095
Mfg. #15507 +
H1⅞" T8"
B6¼" D8"
Cs Pk 1 x 3 dz
Cs Wt 38.00 lb

MODERNO



Salad/Dessert, 8"
Item #370532 +
Mfg. #15427
H½" T8" B3⅞" D8"
Cs Pk 1 x 3 dz
Cs Wt 28.00 lb



Salad/Dessert Plate, 7½"
Item #417635
Mfg. #1788491
H7⅞" T7½" D7½"
Cs Pk 1 x 1 dz
Cs Wt 10.00 lb



Soup/Salad, 9" deep
Item #417894
Mfg. #1788490
H1⅞" T9" D9"
Cs Pk 1 x 1 dz
Cs Wt 14.79 lb

GIBRALTAR®

LIBBEY®
+DuraTuff®



Salad/Dessert Plate, 7½"

Item #370188

Mfg. #15411 +

H 7/8" T 7/8"

B 5" D 7/8"

Cs Pk 1 x 3 dz

Cs Wt 25.00 lb



Soup/Deep Salad Plate, 8", 17¼ oz

Item #369323

Mfg. #15412 +

H 1¼" T 8"

B 5" D 8"

Cs Pk 1 x 3 dz

Cs Wt 31.50 lb

BOUQUET

LIBBEY®
+DuraTuff®

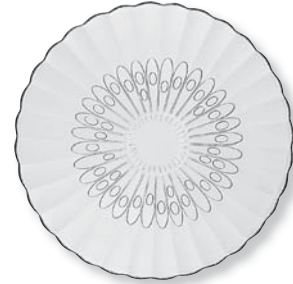

Salad Plate, 7⅝"

Item #370395

Mfg. #15500 +

H 7/8" T 7/8"

B 5½" D 7/8"

Cs Pk 1 x 3 dz

Cs Wt 27.00 lb

FOUNTAINWARE

Libbey
GLASSWARE
A Libbey FOODSERVICE Company



Supreme Liner, 5 oz

Item #369334

Mfg. #5119

H 1¼" T 3¼"

B 1½" D 3¼"

Cs Pk 1 x 6 dz

Cs Wt 19.80 lb



Supreme, 18 oz

Item #369365

Mfg. #5118

H 4½" T 5⅝"

B 4" D 5⅝"

Cs Pk 1 x 2 dz

Cs Wt 31.00 lb



Tulip Sundae, 6½ oz

Item #369417

Mfg. #5115

H 4⅞" T 4"

B 3" D 4"

Cs Pk 1 x 3 dz

Cs Wt 32.00 lb



Soda, 12 oz

Item #388105

Mfg. #5110

H 7½" T 3⅝"

B 3⅝" D 3⅝"

Cs Pk 1 x 2 dz

Cs Wt 28.60 lb



Soda, 11½ oz

Item #369550

Mfg. #5310

H 7⅞" T 3¼"

B 3⅝" D 3¼"

Cs Pk 1 x 2 dz

Cs Wt 34.80 lb



Libbey
GLASSWARE
A Libbey FOODSERVICE Company



Tulip Sundae, 4½ oz

Item #369675

Mfg. #5101

H 4" T 3⅝"

B 2¾" D 3⅝"

Cs Pk 1 x 3 dz

Cs Wt 20.00 lb



Tulip Sundae, 5¼ oz

Item #369278

Mfg. #5314

H 5⅞" T 4¼"

B 3⅝" D 4¼"

Cs Pk 1 x 2 dz

Cs Wt 29.00 lb



Sundae, 6¼ oz

Item #370173

Mfg. #5315

H 5¾" T 4"

B 3⅝" D 4"

Cs Pk 1 x 2 dz

Cs Wt 29.70 lb

+ DuraTuff®

Sold in case pack only.

FOUNTAINWARE



9" Banana Split/Relish Dish
Item #370154
 Mfg. #5317
 H1 7/8" T9"
 B5" D9"
 Cs Pk 1 x 2 dz
 Cs Wt 25.00 lb



Sherbet, 3 1/2 oz
Item #450757
 Mfg. #5102
 H2 1/4" T3 3/4"
 B2 3/4" D3 3/4"
 Cs Pk 1 x 4 dz
 Cs Wt 22.10 lb



Sherbet, 4 1/2 oz
Item #434202
 Mfg. #5103
 H2 3/8" T4 1/8"
 B3" D4 1/8"
 Cs Pk 1 x 4 dz
 Cs Wt 24.10 lb



Sherbet, 3 1/2 oz
Item #370177
 Mfg. #5161
 H2 7/8" T3 1/8"
 B2 3/8" D3 1/8"
 Cs Pk 1 x 6 dz
 Cs Wt 29.00 lb



Sherbet, 4 1/2 oz
Item #369180
 Mfg. #5162
 H3 1/8" T3 1/2"
 B2 5/8" D3 1/2"
 Cs Pk 1 x 6 dz
 Cs Wt 40.00 lb

SERVICE ACCESSORIES



Server, 11 1/2 oz
Item #369203
 Mfg. #5065
 H4 3/4" T2 1/8"
 B2 3/8" D3 1/4"
 Cs Pk 1 x 2 dz
 Cs Wt 8.00 lb



Cruet w/Stopper, 6 oz
Item #370137
 Mfg. #75305
 H4 3/8" T1 1/2"
 B1 3/4" D2 7/8"
 Cs Pk 1 x 1 dz
 Cs Wt 7.00 lb



Ramekin, 1 1/2 oz
Item #369432
 Mfg. #15445 +
 H1 1/8" T2 3/8"
 B1 7/8" D2 3/8"
 Cs Pk 1 x 3 dz
 Cs Wt 4.00 lb



Ramekin, 3 oz
Item #369260
 Mfg. #15446 +
 H1 3/8" T3"
 B2 1/4" D3"
 Cs Pk 1 x 3 dz
 Cs Wt 7.00 lb



Ramekin, 5 oz
Item #369470
 Mfg. #15447 +
 H2" T3 3/8"
 B2 1/4" D3 3/8"
 Cs Pk 1 x 3 dz
 Cs Wt 12.00 lb



Oyster Cocktail, 2 1/4 oz
Item #369404
 Mfg. #5160
 H1 7/8" T2 1/2"
 B1 3/4" D2 1/2"
 Cs Pk 1 x 12 dz
 Cs Wt 26.00 lb



Winchester Shaker
 Chrome Plated Brass Top,
 1 1/2 oz
Item #369414
 Mfg. #70022
 H4 1/8" T1" B2" D2"
 Cs Pk 1 x 2 dz
 Cs Wt 7.00 lb



Shaker Stainless
 Steel Top, 2 oz
Item #369305
 Mfg. #97052
 H4 1/8" T1 1/2"
 B1 1/2" D1 1/2"
 Cs Pk 1 x 6 dz
 Cs Wt 22.00 lb



Shaker Chrome Plated
 Plastic Top, 1 1/4 oz
Item #369653
 Mfg. #5221
 H3 3/8" T1 5/8"
 B1 5/8" D1 1/4"
 Cs Pk 1 x 2 dz
 Cs Wt 9.00 lb



Shaker Chrome Plated
 Plastic Top, 1 1/2 oz
Item #369547
 Mfg. #5037
 H4 1/8" T1 5/8"
 B1 5/8" D2 1/4"
 Cs Pk 1 x 2 dz
 Cs Wt 11.00 lb



Shaker Aluminum Top,
 2 oz
Item #369557
 Mfg. #5045
 H3 3/8" T1 1/4"
 B1 1/2" D1 5/8"
 Cs Pk 1 x 6 dz
 Cs Wt 13.00 lb



Sugar Package Holder, 4 1/4"
Item #369537
 Mfg. #5460
 H2 1/8" T4 1/4"
 B3 3/8" D4 1/4"
 Cs Pk 1 x 2 dz
 Cs Wt 16.00 lb



Sugar Package Holder, 3 1/2"
Item #369183
 Mfg. #5258
 H2 1/8" T3 1/2"
 B3 1/2" D3 1/2"
 Cs Pk 1 x 2 dz
 Cs Wt 10.70 lb

VOTIVES & VASE



Votive Glass, 3/4 oz
Item #369352
 Mfg. #763
 H2 1/2" T2"
 B2" D2"
 Cs Pk 1 x 3 dz
 Cs Wt 6.80 lb



Votive, 4/4 oz
Item #369676
 Mfg. #1965
 H2 1/2" T2 1/8"
 B1 3/8" D2 5/8"
 Cs Pk 1 x 3 dz
 Cs Wt 7.00 lb



Cylinder Bud Vase, 6 3/4"
Item #370867
 Mfg. #2824 ●
 H7 1/2" T1 7/8"
 B1 7/8" D1 7/8"
 Cs Pk 1 x 2 dz
 Cs Wt 12.90 lb

PITCHERS & DECANTERS



Pitcher, 60 oz
Item #369378
Mfg. #5260
H9¼" T5¼"
B4⅞" D7⅞"
Cs Pk 1 x 6 ea
Cs Wt 26.55 lb



Decanter, 21½ oz
Item #370193
Mfg. #789
H7¾" T3½"
B3" D3½"
Cs Pk 1 x 1 dz
Cs Wt 10.00 lb



Decanter, 40 oz
Item #370324
Mfg. #795
H10¾" T3¼"
B3⅞" D3¼"
Cs Pk 1 x 1 dz
Cs Wt 17.00 lb



Wine Decanter/Carafe,
½ liter (19¼ oz)
Item #369479
Mfg. #97001
H8⅞" T3"
B3⅞" D3⅞"
Cs Pk 1 x 1 dz
Cs Wt 13.00 lb



Wine Decanter/Carafe,
1 liter (39¼ oz)
Item #368680
Mfg. #97000
H10⅞" T3½"
B3¼" D3¼"
Cs Pk 1 x 1 dz
Cs Wt 21.00 lb



Cocktail Decanter/
Bud Vase, 4½ oz
Item #370103
Mfg. #718
H3⅞" T1¾"
B1⅞" D2⅞"
Cs Pk 1 x 6 dz
Cs Wt 17.00 lb



Cocktail Decanter/
Bud Vase, 8½ oz
Item #371313
Mfg. #719
H4⅞" T2¼"
B2½" D2¾"
Cs Pk 1 x 3 dz
Cs Wt 12.00 lb

Decanter capacities are rim full



BARRELS

Barrel, 20 liter
Item #370310
Mfg. #9520004
H18½" + T6½"
B8½" D11½"
Cs Pk 1 x 1 ea
Cs Wt 15.00 lb

Barrel, 10 liter
Item #381990
Mfg. #9520003
H15" + T5¼"
B9" D9"
Cs Pk 1 x 2 ea
Cs Wt 17.00 lb



† Height does not include lid

SMOKING ACCESSORIES



Ashtray, 4⅞"
Item #369408
Mfg. #5044
Cs Pk 1 x 3 dz
Cs Wt 25.00 lb



Square Ashtray, 3¾"
Item #368642
Mfg. #5143
Cs Pk 1 x 3 dz
Cs Wt 22.00 lb



Ashtray, 4¼"
Item #369380
Mfg. #5156
Cs Pk 1 x 4 dz
Cs Wt 22.00 lb



Safety Ashtray, 5"
Item #368651
Mfg. #5164
Cs Pk 1 x 3 dz
Cs Wt 22.00 lb



Safety Ashtray, 6½"
Item #369486
Mfg. #5165
Cs Pk 1 x 2 dz
Cs Wt 27.00 lb

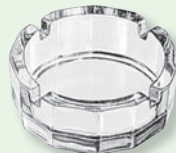

Gibraltar Ashtray, 4"
Item #369619
Mfg. #5172
Cs Pk 1 x 3 dz
Cs Wt 24.00 lb



Winchester Ashtray, 4⅞"
Item #369189
Mfg. #5265
Cs Pk 1 x 3 dz
Cs Wt 22.00 lb



Nob Hill Ashtray, 4"
Item #369163
Mfg. #5154
Cs Pk 1 x 3 dz
Cs Wt 18.00 lb

Sold in case pack only.

NEW ORLEANS



TABLETOP



Rocks, 4 oz
Item #458686
Mfg. #90004 *
H3 3/8" T2 7/8"
B2 1/4" D2 7/8"
Cs Pk 1 x 3 dz
Cs Wt 23.00 lb



Rocks, 5 oz
Item #458840
Mfg. #90005 *
H3 3/8" T2 7/8"
B2 1/4" D2 7/8"
Cs Pk 1 x 3 dz
Cs Wt 20.00 lb



Rocks, 7 oz
Item #458841
Mfg. #90006 +*
H3 3/8" T3 1/4"
B2 1/2" D3 1/4"
Cs Pk 1 x 3 dz
Cs Wt 27.00 lb



Rocks, 8 oz
Item #458843
Mfg. #90007 +*
H3 3/8" T3 3/8"
B2 1/2" D3 3/8"
Cs Pk 1 x 3 dz
Cs Wt 27.00 lb



Rocks, 9 oz
Item #458847
Mfg. #90008 +*
H3 3/8" T3 3/8"
B2 1/2" D3 3/8"
Cs Pk 1 x 3 dz
Cs Wt 22.00 lb



Rocks, 9 oz
Item #379195
Mfg. #799U *
H3 7/8" T3 1/2"
B2 1/2" D3 1/2"
Cs Pk 1 x 3 dz
Cs Wt 30.00 lb



Rocks, 10 oz
Item #458850
Mfg. #90009 *
H3 7/8" T3 1/2"
B2 1/2" D3 1/2"
Cs Pk 1 x 3 dz
Cs Wt 30.00 lb



Double Rocks, 12 oz
Item #458864
Mfg. #90010 +*
H4 1/4" T3 7/8"
B2 3/4" D3 7/8"
Cs Pk 1 x 3 dz
Cs Wt 36.00 lb



Hi-Ball, 9 oz
Item #379174
Mfg. #7729U +*
H4 3/4" T3 1/8"
B2 1/2" D3 1/8"
Cs Pk 1 x 3 dz
Cs Wt 35.00 lb



Beverage, 10 oz
Item #379176
Mfg. #7730U +*
H4 3/4" T3 1/8"
B2 1/2" D3 1/8"
Cs Pk 1 x 3 dz
Cs Wt 30.00 lb



Beverage, 12 oz
Item #379179
Mfg. #7732U +*
H4 7/8" T3 3/8"
B2 3/4" D3 3/8"
Cs Pk 1 x 3 dz
Cs Wt 36.00 lb



Iced Tea, 14 1/2 oz
Item #379183
Mfg. #7745U +*
H5 1/8" T3 1/2"
B2 3/4" D3 3/8"
Cs Pk 1 x 3 dz
Cs Wt 38.00 lb



Cooler, 12 oz
Item #379180
Mfg. #7733U +*
H5 5/8" T3 1/8"
B2 1/4" D3 1/8"
Cs Pk 1 x 3 dz
Cs Wt 34.00 lb



Cooler, 16 oz
Item #379000
Mfg. #77746 +*
H6 3/8" T3 3/8"
B2 1/2" D3 3/8"
Cs Pk 1 x 3 dz
Cs Wt 40.00 lb



Iced Tea, 22 oz
Item #378999
Mfg. #77722 +*
H7" T3 3/4"
B2 3/4" D3 3/4"
Cs Pk 1 x 2 dz
Cs Wt 37.00 lb

EXCELLENCY™



Wine, 6 1/2 oz
Item #379067
Mfg. #2926M *
H5 3/8" T2 3/8"
B2 1/2" D2 3/8"
Cs Pk 1 x 3 dz
Cs Wt 14.00 lb



Wine, 8 1/2 oz
Item #379068
Mfg. #2928M *
H5 5/8" T2 3/8"
B2 3/4" D3"
Cs Pk 1 x 3 dz
Cs Wt 18.00 lb



Wine, 10 1/2 oz
Item #379069
Mfg. #2930M *
H6" T3 1/8"
B2 3/4" D3 3/8"
Cs Pk 1 x 3 dz
Cs Wt 19.00 lb



Wine, 6 1/2 oz
Item #379073
Mfg. #2936M *
H6 1/4" T2 1/8"
B2 5/8" D2 1/2"
Cs Pk 1 x 3 dz
Cs Wt 15.00 lb



Wine, 8 1/2 oz
Item #427500
Mfg. #2938M *
H6 3/8" T2 3/8"
B2 5/8" D2 3/4"
Cs Pk 1 x 3 dz
Cs Wt 16.00 lb

EXCELLENCY™



TABLETOP



Goblet, 10½ oz
Item #379141
Mfg. #7221M *
H5¼" T2⅝"
B2⅞" D3⅞"
Cs Pk 1 x 3 dz
Cs Wt 20.00 lb



Goblet, 10½ oz
Item #379070
Mfg. #2931M *
H5¾" T3"
B2¾" D3"
Cs Pk 1 x 3 dz
Cs Wt 20.00 lb



Goblet, 11½ oz
Item #379071
Mfg. #2932M *
H6" T2⅞"
B3" D3⅞"
Cs Pk 1 x 3 dz
Cs Wt 20.00 lb



Pilsner, 12 oz
Item #379076
Mfg. #2942M *
H7⅞" T2½"
B2⅝" D2⅞"
Cs Pk 1 x 3 dz
Cs Wt 20.00 lb



Footed Hi-Ball, 8 oz
Item #379062
Mfg. #2908M *
H5½" T2¼"
B2¾" D2¾"
Cs Pk 1 x 3 dz
Cs Wt 20.00 lb



Footed Hi-Ball, 10 oz
Item #379063
Mfg. #2910M *
H6" T2⅞"
B2¾" D2⅞"
Cs Pk 1 x 3 dz
Cs Wt 21.00 lb



Footed Rocks, 5½ oz
Item #379065
Mfg. #2915M *
H4¼" T3⅞"
B2¾" D3"
Cs Pk 1 x 3 dz
Cs Wt 18.00 lb



Footed Rocks, 7 oz
Item #427944
Mfg. #2907M *
H4⅝" T3¼"
B2¾" D3¼"
Cs Pk 1 x 3 dz
Cs Wt 20.00 lb



Brandy, 6 oz
Item #446503
Mfg. #3950M *
H4" T2⅞"
B2⅝" D3"
Cs Pk 1 x 2 dz
Cs Wt 7.00 lb



Brandy, 9 oz
Item #379114
Mfg. #3933M *
H4½" T2¼"
B2½" D3⅞"
Cs Pk 1 x 2 dz
Cs Wt 12.00 lb



Brandy, 12 oz
Item #379116
Mfg. #3951M *
H4¾" T2½"
B2¾" D3⅞"
Cs Pk 1 x 2 dz
Cs Wt 12.00 lb



FLORENTINE™



Wine, 8½ oz
Item #379012
Mfg. #80018 *
H7¼" T2½"
B2¾" D2⅞"
Cs Pk 1 x 2 dz
Cs Wt 11.00 lb



All Purpose Wine, 11 oz
Item #379015
Mfg. #80021 *
H7⅝" T2⅞"
B3" D3¼"
Cs Pk 1 x 2 dz
Cs Wt 13.00 lb

FLORENTINE™



Red Wine, 13 oz
Item #379009
Mfg. #80013 *
H7½" T3"
B3" D3½"
Cs Pk 1 x 2 dz
Cs Wt 13.00 lb



Martini, 8½ oz
Mini 4 Case
Item #518392
Mfg. #90071 *
H6½" D4½"
Cs Pk 1 x 2 dz
Cs Wt 24.50 lb



Flute, 6 oz
Item #379013
Mfg. #80019 *
H8½" T1⅞"
B2½" D2⅞"
Cs Pk 1 x 2 dz
Cs Wt 10.00 lb



MARBEYA



Martini, 9 oz
Item #390644
Mfg. #80226X *
H7" T4½" B2⅞" D4½"
Cs Pk 1 x 1 dz
Cs Wt 7.00 lb

ASHBURY



Martini, 6 oz
Item #396628
Mfg. #H037491 *
H5¾" T4⅞"
B2⅞" D4⅞"
Cs Pk 1 x 3 dz
Cs Wt 17.00 lb



SPECIALTY STEMWARE



Celebrate Martini, 9 oz
Item #387645
Mfg. #80278X *
H6¾" T4½"
B3" D4½"
Cs Pk 1 x 1 dz
Cs Wt 7.00 lb



Poco, 10½ oz
Item #379052
Mfg. #2081M *+
H7" T2¾"
B2⅞" D3"
Cs Pk 1 x 2 dz
Cs Wt 14.00 lb



Poco, 13½ oz
Item #379053
Mfg. #2085M *+
H7" T2⅞"
B2¾" D3⅞"
Cs Pk 1 x 1 dz
Cs Wt 8.00 lb



Footed Hurricane, 15 oz
Item #379120
Mfg. #524UX *+
H8¼" T3⅞"
B3" D3⅞"
Cs Pk 1 x 1 dz
Cs Wt 11.00 lb



Margarita, 12 oz
Item #379064
Mfg. #2912UX *
H6⅞" T4¼"
B3¼" D4⅞"
Cs Pk 1 x 2 dz
Cs Wt 17.00 lb



Margarita, 15¼ oz
Item #379054
Mfg. #2095UX *
H6" T4¾"
B3⅞" D4⅞"
Cs Pk 1 x 1 dz
Cs Wt 9.00 lb



Margarita, 16¾ oz
Item #379066
Mfg. #2917UX *
H6¼" T4¾"
B3⅞" D5"
Cs Pk 1 x 1 dz
Cs Wt 10.00 lb

WEINLAND



Flute, 6¾ oz
Item #506970
Mfg. #100-00-07 *
H8¼" T1¾"
B2¾" D2¼"
Cs Pk 1 x 4 dz
Cs Wt 18.00 lb



All Purpose 12, 12 oz
Item #531438
Mfg. #100-00-02 *
H7¾" T2½"
B3" D3"
Cs Pk 1 x 4 dz
Cs Wt 21.00 lb



All Purpose 15, 15 oz
Item #506969
Mfg. #100-00-01 *
H8" T2½"
B3" D3¼"
Cs Pk 1 x 4 dz
Cs Wt 25.00 lb



Cabernet/Bordeaux,
18 oz
Item #518198
Mfg. #100-00-35 *
H8¼" T2¾"
B3¼" D3½"
Cs Pk 1 x 4 dz
Cs Wt 26.00 lb



Cabernet/Bordeaux,
22¼ oz
Item #506971
Mfg. #100-00-37 *
H8¾" T2¾"
B3¼" D3¾"
Cs Pk 1 x 4 dz
Cs Wt 29.00 lb



Water, 16 oz
Item #530774
Mfg. #283-00-11 *
H6" T2¾"
B3" D3¼"
Cs Pk 1 x 4 dz
Cs Wt 22.00 lb



Rocks, 9¼ oz
Item #523408
Mfg. #100-00-15 *
H3½" T2¼"
B2¼" D3"
Cs Pk 1 x 4 dz
Cs Wt 25.00 lb



D.O.F., 11 oz
Item #516752
Mfg. #100-00-16 *
H3½" T3"
B2¾" D3¼"
Cs Pk 1 x 4 dz
Cs Wt 30.00 lb



Tumbler, 10½ oz
Item #523406
Mfg. #100-00-09 *
H5" T2½"
B2¼" D2½"
Cs Pk 1 x 4 dz
Cs Wt 22.00 lb



Tall Tumbler, 13 oz
Item #523405
Mfg. #100-00-12 *
H5¾" T2½"
B2¼" D2½"
Cs Pk 1 x 4 dz
Cs Wt 21.00 lb

WEISS



Goblet, 18 oz
Item #489881
Mfg. #03212 *
H7½" T4½"
B3¾" D4¾"
Cs Pk 1 x 1 dz
Cs Wt 36.00 lb



Goblet, 20 oz
Item #489884
Mfg. #07767 *
H7½" T5"
B3¾" D5"
Cs Pk 1 x 1 dz
Cs Wt 36.00 lb

BEER MUGS



Beer Wagon, 10 oz
Item #379026
Mfg. #1150U *
H5½" T2¾"
B2¾" D4¾"
Cs Pk 1 x 2 dz
Cs Wt 31.00 lb



Beer Wagon, 12 oz
Item #379027
Mfg. #1152U *
H5¾" T3"
B2¾" D4½"
Cs Pk 1 x 2 dz
Cs Wt 37.00 lb



Beer Mug, 12 oz
Item #379047
Mfg. #18U *
H5½" T3½"
B2¾" D4¾"
Cs Pk 1 x 2 dz
Cs Wt 36.00 lb

BEER MUGS



Gusto Mug, 1 Liter
Item #379028
Mfg. #1153U *
H8" T4"
B4" D6"
Cs Pk 1 x 1 dz
Cs Wt 39.00 lb



Handled Beer, 22 oz
16¼ oz mark
Item #387675
Mfg. #133450 *
H7¼" T3½"
B3¼" D5½"
Cs Pk 1 x 6 ea
Cs Wt 24.20 lb



Beer Tankard, 10 oz
Item #379033
Mfg. #1170U *
H5½" T2½"
B3¼" D4½"
Cs Pk 1 x 1 dz
Cs Wt 25.00 lb



Beer Tankard, 12 oz
Item #379034
Mfg. #1172U *
H5½" T2½"
B3¼" D4½"
Cs Pk 1 x 1 dz
Cs Wt 21.00 lb

BARBARY

Use serving paddles to increase your beer sales and profits. Serve your customers four different beers (at your 13 oz price) using Barbary 2.5 oz beer shots and then put their select choice in a 13, 16 or 20 oz beer glass. Or, use the paddle to serve four 5 oz Barbary Beer Taster glasses at your 20 oz price.



Sample Paddle
Item #482542
Mfg. #90038 *
H½" L14½"
Cs Pk 1 x 1 dz
Cs Wt 8.00 lb



Beer, 4½ oz
Item #480555
Mfg. #93013 *
H4" T2¼"
B1¾" D2½"
Cs Pk 1 x 2 dz
Cs Wt 6.00 lb



Beer, 13 oz
Item #480554
Mfg. #93012 *
H6¼" T2½"
B2½" D2¾"
Cs Pk 1 x 2 dz
Cs Wt 10.00 lb



Beer, 16 oz
Item #480553
Mfg. #93011 *
H6½" T3½"
B2¾" D3¼"
Cs Pk 1 x 2 dz
Cs Wt 17.00 lb



Beer, 20 oz
Item #480552
Mfg. #93010 *
H7" T2½"
B2¾" D3¼"
Cs Pk 1 x 2 dz
Cs Wt 18.00 lb

SHOT GLASSES



Whiskey, ¾ oz
Item #388133
Mfg. #3666EU *
H2¼" T1½"
B1¾" D1¾"
Cs Pk 1 x 6 *
Cs Wt 26.00 lb



Whiskey, 7/8 oz
Item #386087
Mfg. #3667EU *
H2¼" T2"
B1¾" D2"
Cs Pk 1 x 6 dz *
Cs Wt 24.00 lb



Whiskey, 1 oz
Item #379111
Mfg. #3668U *
H2¼" T2"
B1¾" D2"
Cs Pk 1 x 6 dz
Cs Wt 22.00 lb



Whiskey, 1½ oz
Item #379123
Mfg. #5281U *
H2½" T2¼"
B1¾" D2¼"
Cs Pk 1 x 4 dz *
Cs Wt 27.50 lb



Whiskey, 2 oz
Item #379126
Mfg. #5282U *
H2½" T2¼"
B1¾" D2¼"
Cs Pk 1 x 4 dz
Cs Wt 23.30 lb



Whiskey, 1½ oz
w/¾ oz Cap Line
Item #379121
Mfg. #5281/931U *
H2½" T2¼"
B1¾" D2¼"
Cs Pk 1 x 4 dz *
Cs Wt 27.50 lb



Whiskey, 1½ oz
w/7/8 oz Cap Line
Item #379122
Mfg. #5281/932U *
H2½" T2¼"
B1¾" D2¼"
Cs Pk 1 x 4 dz *
Cs Wt 27.50 lb



Whiskey, 2 oz
w/1 oz Cap Line
Item #379124
Mfg. #5282/928U *
H2½" T2¼"
B1¾" D2¼"
Cs Pk 1 x 4 dz *
Cs Wt 23.30 lb



Whiskey, 1¼ oz
w/½ oz Cap Line
Item #389447
Mfg. #5280/1612UL *
H2½" T2¼"
B1¾" D2¼"
Cs Pk 1 x 6 dz
Cs Wt 43.00 lb



Whiskey Taster, 3 oz
Item #389980
Mfg. #2283Q *
H2½" T2¼"
B2" D2½"
Cs Pk 1 x 3 dz
Cs Wt 10.00 lb

SOLACE™



Cooler, 15¼ oz
Item #527923
 Mfg. #90054A *+
 H5½" T3" B2½" D3¼"
 Cs Pk 1 x 2 dz
 Cs Wt 21.00 lb

BULGE-TOP PILSNER



Pilsner, 23 oz
Item #426104
 Mfg. #80436 *
 H9¾" T2½"
 B2¾" D3¾"
 Cs Pk 1 x 2 dz
 Cs Wt 12.00 lb



Footed Beer, 13 oz
Item #448203
 Mfg. #165270 *+
 H9¾" T2½"
 B2¾" D2¾"
 Cs Pk 1 x 6 ea
 Cs Wt 5.10 lb



Treva Pilsner, 14 oz
Item #396619
 Mfg. #H023202 *+
 H9¾" T2½"
 B2¾" D2¾"
 Cs Pk 1 x 2 dz
 Cs Wt 26.00 lb

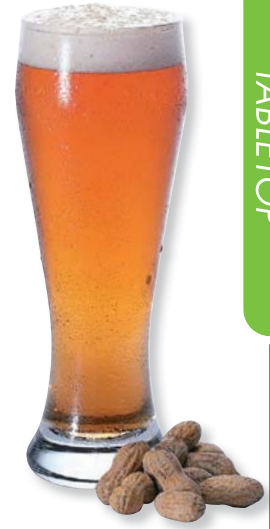

PILSNER



Bavarian Pilsner, 9 oz
Item #379153
 Mfg. #7409U *+
 H5½" T2½"
 B2¼" D2½"
 Cs Pk 1 x 3 dz
 Cs Wt 22.00 lb



Bavarian Pilsner, 10 oz
Item #379154
 Mfg. #7410U *+
 H5¼" T2½"
 B2¼" D2½"
 Cs Pk 1 x 3 dz
 Cs Wt 23.00 lb



Bavarian Pilsner, 12 oz
Item #379155
 Mfg. #7412U *+
 H6" T3¼"
 B2½" D3¼"
 Cs Pk 1 x 3 dz
 Cs Wt 27.00 lb

CLARISSE™



Rocks, 7 oz
Item #379188
 Mfg. #77787 *+
 H3¾" T3¼"
 B2¾" D3¼"
 Cs Pk 1 x 3 dz
 Cs Wt 26.00 lb



Rocks, 8 oz
Item #379191
 Mfg. #77788R *+
 H3¾" T3¼"
 B2¾" D3¼"
 Cs Pk 1 x 3 dz
 Cs Wt 24.00 lb



Rocks, 10 oz
Item #379001
 Mfg. #77770 *+
 H3¾" T3½"
 B2¾" D3½"
 Cs Pk 1 x 3 dz
 Cs Wt 33.00 lb



Rocks, 12 oz
Item #379192
 Mfg. #77790R *+
 H4" T3¾"
 B2½" D3¾"
 Cs Pk 1 x 3 dz
 Cs Wt 39.00 lb



Beverage, 12 oz
Item #379193
 Mfg. #77792R *+
 H4½" T3¼"
 B2¼" D3¼"
 Cs Pk 1 x 3 dz
 Cs Wt 38.00 lb



Beverage, 14 oz
Item #379002
 Mfg. #77794 *+
 H5½" T3¾"
 B2¼" D3¾"
 Cs Pk 1 x 3 dz
 Cs Wt 34.00 lb



Cooler, 16 oz
Item #386405
 Mfg. #77796 *+
 H6½" T3¾"
 B2½" D3¾"
 Cs Pk 1 x 3 dz
 Cs Wt 38.00 lb



* Sure Guard™ Guarantee + Rim-Tempered

Sold in case pack only.

BRECKENRIDGE™



Hi-Ball, 9 oz
Item #379005
Mfg. #80009 *+
H4⁷/₈" T2³/₄"
B2" D2³/₄"
Cs Pk 1 x 3 dz
Cs Wt 23.00 lb



Beverage, 12¹/₂ oz
Item #379008
Mfg. #80012 *+
H5³/₈" T3¹/₈"
B2¹/₄" D3¹/₈"
Cs Pk 1 x 3 dz
Cs Wt 25.00 lb



Cooler, 16 oz
Item #379011
Mfg. #80016 *+
H5⁵/₈" T3¹/₄"
B2³/₈" D3¹/₄"
Cs Pk 1 x 3 dz
Cs Wt 37.00 lb



Goblet, 10¹/₂ oz
Item #379007
Mfg. #80011 *+
H6" T3¹/₄"
B2⁷/₈" D3¹/₄"
Cs Pk 1 x 3 dz
Cs Wt 35.00 lb

STACKABLES™



Beverage, 10 oz
Item #382816
Mfg. #73010 *+
H4³/₄" T3¹/₈"
B1³/₄" D3¹/₈"
Cs Pk 1 x 3 dz
Cs Wt 21.50 lb



Cooler, 16 oz
Item #379146
Mfg. #73017 *+
H6" T3¹/₂"
B2¹/₄" D3¹/₂"
Cs Pk 1 x 3 dz
Cs Wt 35.00 lb

MIXING GLASSES



Mixing Glass, 14 oz
Item #378993
Mfg. #77174 *+
H5⁵/₈" T3¹/₂"
B2³/₈" D3¹/₂"
Cs Pk 1 x 3 dz
Cs Wt 43.00 lb



Mixing Glass, 16 oz
Item #379045
Mfg. #176FU *
Item #379135
Mfg. #7176FU *+
H5⁵/₈" T3¹/₄"
B2³/₈" D3¹/₄"
Cs Pk 1 x 2 dz
Cs Wt 24.00 lb



Mixing Glass, 20 oz
Item #378994
Mfg. #77420 *+
H6⁷/₈" T3³/₈"
B2³/₈" D3³/₈"
Cs Pk 1 x 2 dz
Cs Wt 33.00 lb



Mixing Glass, 22 oz
Item #383500
Mfg. #77422 *+
H6⁷/₈" T3³/₈"
B2³/₈" D3³/₈"
Cs Pk 1 x 2 dz
Cs Wt 27.00 lb



SOHO



Old Fashioned, 8¹/₂ oz
Item #414012
Mfg. #H054504 *
H3³/₈" T3"
B2³/₄" D3"
Cs Pk 1 x 2 dz
Cs Wt 20.00 lb



Dbl. Old Fashioned, 11 oz
Item #414010
Mfg. #H054539 *
H3³/₈" T3¹/₈"
B3" D3¹/₈"
Cs Pk 1 x 2 dz
Cs Wt 22.00 lb



Collins, 11¹/₂ oz
Item #417017
Mfg. #H054540 *
H5¹/₂" T2⁵/₈"
B2⁵/₈" D2⁵/₈"
Cs Pk 1 x 2 dz
Cs Wt 21.00 lb

TARTAN®



Rocks, 10¹/₂ oz
Item #378990
Mfg. #68349 *
H3¹/₂" T3¹/₄"
B3³/₈" D3³/₈"
Cs Pk 1 x 1 dz
Cs Wt 10.00 lb



Iced Tea, 16 oz
Item #425571
Mfg. #68347 *
H6" T3"
B3¹/₈" D3¹/₈"
Cs Pk 1 x 1 dz
Cs Wt 15.00 lb

TUMBLERS



Room Tumbler, 8 oz
Item #379055
 Mfg. #2238U *
 H3 $\frac{3}{8}$ " T2 $\frac{3}{4}$ "
 B2 $\frac{1}{2}$ " D2 $\frac{3}{4}$ "
 Cs Pk 1 x 6 dz
 Cs Wt 38.00 lb



Barrel Tumbler, 9 oz
Item #386901
 Mfg. #5054U *
 H3 $\frac{3}{8}$ " T2 $\frac{3}{8}$ "
 B2 $\frac{1}{4}$ " D3"
 Cs Pk 1 x 3 dz
 Cs Wt 24.00 lb

CONCORD



Old Fashioned, 10 $\frac{1}{2}$ oz
Item #379089
 Mfg. #3141U *
 H3 $\frac{1}{2}$ " T3 $\frac{1}{4}$ "
 B3 $\frac{1}{4}$ " D3 $\frac{1}{4}$ "
 Cs Pk 1 x 3 dz
 Cs Wt 27.00 lb



Dbl. Old Fashioned, 12 $\frac{1}{2}$ oz
Item #379090
 Mfg. #3143U *
 H4" T3 $\frac{1}{4}$ "
 B3 $\frac{1}{4}$ " D3 $\frac{1}{4}$ "
 Cs Pk 1 x 3 dz
 Cs Wt 29.00 lb



TABLETOP

BEACON HILL™



Old Fashioned, 10 $\frac{1}{4}$ oz
Item #379050
 Mfg. #2047U *
 H3 $\frac{3}{8}$ " T3 $\frac{1}{4}$ "
 B3 $\frac{1}{8}$ " D3 $\frac{1}{4}$ "
 Cs Pk 1 x 3 dz
 Cs Wt 27.00 lb



Old Fashioned, 12 $\frac{1}{4}$ oz
Item #379051
 Mfg. #2051U *
 H3 $\frac{3}{8}$ " T3 $\frac{1}{8}$ "
 B3 $\frac{1}{8}$ " D3 $\frac{1}{4}$ "
 Cs Pk 1 x 3 dz
 Cs Wt 27.00 lb

REGENCY
HEAVY BASE

Hi-Ball, 8 oz.
Item #379082
 Mfg. #3108U ■
 H4 $\frac{7}{8}$ " T2 $\frac{3}{8}$ "
 B2 $\frac{1}{4}$ " D2 $\frac{1}{2}$ "
 Cs. Pk. 1 x 6 dz.
 Cs. Wt. 38.00 lb.



REALITY™



Rocks, 10 oz
Item #489846
 Mfg. #90044 *†
 H3 $\frac{3}{4}$ " T2 $\frac{3}{8}$ "
 B2 $\frac{1}{2}$ " D3 $\frac{3}{8}$ "
 Cs Pk 1 x 2 dz
 Cs Wt 14.00 lb

HEAVY BASE



Rocks, 9 oz
Item #379100
 Mfg. #3178FU *
 H3 $\frac{1}{4}$ " T3 $\frac{1}{8}$ "
 B2 $\frac{3}{4}$ " D3 $\frac{1}{8}$ "
 Cs Pk 1 x 3 dz
 Cs Wt 20.00 lb



Double Rocks, 13 oz
Item #379086
 Mfg. #3113U *
 H4" T3 $\frac{3}{8}$ "
 B2 $\frac{3}{4}$ " D3 $\frac{3}{8}$ "
 Cs Pk 1 x 3 dz
 Cs Wt 29.00 lb



Hi-Ball, 7 oz
Item #379093
 Mfg. #3167U *
 H4 $\frac{3}{8}$ " T2 $\frac{1}{2}$ "
 B2" D2 $\frac{1}{2}$ "
 Cs Pk 1 x 6 dz
 Cs Wt 31.00 lb



Hi-Ball, 8 oz
Item #379094
 Mfg. #3168U *
 H4 $\frac{5}{8}$ " T2 $\frac{5}{8}$ "
 B2 $\frac{1}{8}$ " D2 $\frac{5}{8}$ "
 Cs Pk 1 x 6 dz
 Cs Wt 39.00 lb



Hi-Ball, 9 oz
Item #379095
 Mfg. #3169U *
 H4 $\frac{1}{4}$ " T2 $\frac{5}{8}$ "
 B2 $\frac{1}{4}$ " D2 $\frac{5}{8}$ "
 Cs Pk 1 x 6 dz
 Cs Wt 39.00 lb



Hi-Ball, 10 $\frac{1}{2}$ oz
Item #379096
 Mfg. #3170U *
 H5 $\frac{1}{8}$ " T2 $\frac{5}{8}$ "
 B2 $\frac{1}{4}$ " D2 $\frac{5}{8}$ "
 Cs Pk 1 x 6 dz
 Cs Wt 42.00 lb



Beverage, 12 $\frac{1}{2}$ oz
Item #379097
 Mfg. #3172U *
 H5 $\frac{1}{2}$ " T2 $\frac{5}{8}$ "
 B2 $\frac{3}{8}$ " D2 $\frac{5}{8}$ "
 Cs Pk 1 x 6 dz
 Cs Wt 47.00 lb



Collins, 10 $\frac{1}{2}$ oz
Item #379101
 Mfg. #3181EU *
 H6" T2 $\frac{1}{2}$ "
 B2 $\frac{1}{4}$ " D2 $\frac{1}{2}$ "
 Cs Pk 1 x 3 dz
 Cs Wt 22.00 lb



Iced Tea, 15 oz
Item #379098
 Mfg. #3175U *
 H6 $\frac{1}{4}$ " T3"
 B2 $\frac{1}{2}$ " D3"
 Cs Pk 1 x 3 dz
 Cs Wt 30.00 lb

* Sure Guard™ Guarantee † Rim-Tempered

Sold in case pack only.

NEW YORK



Rocks, 8½ oz
Item #523399
 Mfg. #350-00-46 *
 H3¼" T3"
 B3" D3"
 Cs Pk 1 x 4 dz
 Cs Wt 34.00 lb



Tumbler, 12¾ oz
Item #531256
 Mfg. #350-00-10 *
 H6" T2¾"
 B2½" D2¾"
 Cs Pk 1 x 4 dz
 Cs Wt 36.00 lb

MUGS



Punch Cup, 6 oz
Item #379058
 Mfg. #279U *
 H2¾" T3¾"
 B1¾" D4¼"
 Cs Pk 1 x 3 dz
 Cs Wt 15.00 lb



Irish Coffee, 8 oz
Item #383413
 Mfg. #308U *
 H5¼" T3"
 B2½" D4"
 Cs Pk 1 x 2 dz
 Cs Wt 20.00 lb

STRAIGHT-SIDED SHELLS



Hi-Ball, 8 oz
Item #379159
 Mfg. #7513U +*
 H4¾" T2½"
 B2½" D2½"
 Cs Pk 1 x 6 dz
 Cs Wt 27.00 lb



Collins, 10 oz
Item #379160
 Mfg. #7514U +*
 H4¾" T2¾"
 B2¼" D2¾"
 Cs Pk 1 x 6 dz
 Cs Wt 30.00 lb



Zombie, 12 oz
Item #379107
 Mfg. #3532U +*
 H6½" T2¼"
 B2½" D2¼"
 Cs Pk 1 x 6 dz
 Cs Wt 35.00 lb



Zombie, Frosted, 12 oz
Item #379106
 Mfg. #3532/6721U +*
 H6½" T2¼"
 B2½" D2¼"
 Cs Pk 1 x 6 dz
 Cs Wt 35.00 lb



Seltzer, 6 oz
Item #395499
 Mfg. #7511U +*
 H3½" T2¾"
 B2½" D2¾"
 Cs Pk 1 x 6 dz
 Cs Wt 20.00 lb

STORAGE



Jar/Cover, 1 Gallon
Item #385609
 Mfg. #69349T *
 H10" T6¾" B7" D7¾"
 Cs Pk 1 x 1 ea
 Cs Wt 5.00 lb



Jar/Cover, 2 Gallon
Item #382870
 Mfg. #69372T *
 H13¾" T9" B9" D9¾"
 Cs Pk 1 x 1 ea
 Cs Wt 10.00 lb



Jar/Cover, 1 Gallon
Item #400256
 Mfg. #69590R *
 H8½" T4¼"
 B5½" D8¾"
 Cs Pk 1 x 4 ea
 Cs Wt 15.00 lb

Jar/Cover w/Stand,
 2 Gallon
Item #394226
 Mfg. #80142 *+
 H9½" T4¾"
 B5½" D8¾"
 Cs Pk 1 x 2 ea
 Cs Wt 14.76 lb

DESSERT



Anchor Hocking Foodservice



Waverly Sherbet, 5 oz
Item #379129
 Mfg. #56EU *
 H2½" T3¼" B2⅛" D3¾"
 Cs Pk 1 x 3 dz
 Cs Wt 15.00 lb



Footed Sherbet, 4½ oz
Item #379130
 Mfg. #575GU *
 H4⅛" T3⅝" B2¾" D3⅝"
 Cs Pk 1 x 3 dz
 Cs Wt 20.00 lb



Tulip Sundae, 5½ oz
Item #379128
 Mfg. #563FU *
 H6" T4" B3⅛" D4"
 Cs Pk 1 x 3 dz
 Cs Wt 31.00 lb



Soda, 12½ oz
Item #379127
 Mfg. #562U *
 H6¾" T3½" B3⅛" D3⅝"
 Cs Pk 1 x 3 dz
 Cs Wt 40.00 lb

CARAFES/PITCHERS



Anchor Hocking Foodservice

Beer Wagon, 55 oz
Item #379030
 Mfg. #1155UR +*
 H9⅞" T5½"
 B4" D7"
 Cs Pk 1 x 6 ea
 Cs Wt 24.00 lb



Carafe, ½ liter (19¼ oz)
Item #379035
 Mfg. #121UR *
 H9" T2⅞"
 B3¼" D3¼"
 Cs Pk 1 x 1 dz
 Cs Wt 16.00 lb



Carafe, 1 liter (39¾ oz)
Item #379037
 Mfg. #139UR *
 H11" T3"
 B4⅞" D4⅞"
 Cs Pk 1 x 1 dz
 Cs Wt 25.00 lb

SERVICE ACCESSORIES



Tower Shaker w/
 Chrome Top, 1 oz
Item #379132
 Mfg. #6099U *
 H4½" T1" B2" D2"
 Cs Pk 1 x 2 dz
 Cs Wt 8.00 lb



Shaker w/Aluminum
 Top, 2 oz
Item #379046
 Mfg. #1830EU *
 H3⅝" T1⅝" B1⅝" D1⅝"
 Cs Pk 1 x 3 dz
 Cs Wt 7.00 lb



Salt & Pepper Shaker, 2 oz
Item #379043
 Mfg. #16U *
 H4¼" T1⅝" B1⅝" D2⅛"
 Cs Pk 1 x 2 dz
 Cs Wt 11.00 lb



Cruet/Stopper, 10 oz
Item #425325
 Mfg. #980R *
 H6½" T1⅝" B1½" D3½"
 Cs Pk 1 x 6 ea
 Cs Wt 5.00 lb

DINNERWARE

Swedish Modern Plate, 6¼"
Item #379200
 Mfg. #828U *
 Cs Pk 1 x 3 dz
 Cs Wt 16.00 lb

Swedish Modern Plate, 8"
Item #379201
 Mfg. #842U *
 Cs Pk 1 x 3 dz
 Cs Wt 28.00 lb



ASHTRAYS



Square, 3⅝"
Item #379038
 Mfg. #143U *
 Cs Pk 1 x 3 dz
 Cs Wt 21.00 lb



Round Snuffer, 4⅜"
Item #379040
 Mfg. #148U *
 Cs Pk 1 x 3 dz
 Cs Wt 21.00 lb



Stacking Safety, 5"
Item #379143
 Mfg. #72U *
 Cs Pk 1 x 3 dz
 Cs Wt 21.00 lb

CAPRI



Flute, 7¼ oz
Item #531661
Mfg. #366087
H8½" T2"
B2¾"
Cs Pk 1 x 1 dz
Cs Wt 6.00 lb



Tall Wine, 11½ oz
Item #531658
Mfg. #101226
H8" T3"
B3"
Cs Pk 1 x 1 dz
Cs Wt 8.00 lb

Cardinal



Imperial Plus Wine, 6½ oz
Item #531668
Mfg. #432100 ✦
H6½" T2½"
B3"
Cs Pk 1 x 2 dz
Cs Wt 9.00 lb



Imperial Burgundy, 15¼ oz
Item #531667
Mfg. #455078
H8" T3"
B2⅞"
Cs Pk 1 x 2 dz
Cs Wt 16.00 lb

Elemental



Red Wine, 8 oz
Item #531666
Mfg. #899289
H6" T3"
B2¾"
Cs Pk 1 x 3 dz
Cs Wt 17.00 lb



Banquet Goblet, 10 oz
Item #531660
Mfg. #332103 +
H5½" T3"
B2¾"
Cs Pk 1 x 3 dz
Cs Wt 21.00 lb



Goblet, 11¼ oz
Item #531657
Mfg. #101223 +
H6¼" T3"
B2¾"
Cs Pk 1 x 3 dz
Cs Wt 20.00 lb



Brandy, 9 oz
Item #531665
Mfg. #887209
H4¾" T2½"
B2½"
Cs Pk 1 x 2 dz
Cs Wt 11.00 lb



Beer, 12½ oz
Item #531659
Mfg. #102086
H7¼" T2½"
B2¾"
Cs Pk 1 x 3 dz
Cs Wt 21.00 lb

EXCALIBUR



Flute, 5¼ oz
Item #531497
Mfg. #71086 ✦
H7¾" T2"
B2½" D2½"
Pk 1 x 3 dz
Cs Wt 12.00 lb



Ballon Wine, 8½ oz
Item #531494
Mfg. #71082 ✦
H6⅞" T2⅞"
B2¾" D3¼"
Cs Pk 1 x 3 dz
Cs Wt 15.00 lb



Grand Ballon, 13 oz
Item #531693
Mfg. #71075 ✦
H6⅞" T3⅞"
B3" D3⅞"
Cs Pk 1 x 2 dz
Cs Wt 14.00 lb



Tall Wine, 8½ oz
Item #531496
Mfg. #71084 ✦
H6⅜" T2⅞"
B2¾" D2⅞"
Cs Pk 1 x 3 dz
Cs Wt 15.00 lb



Tall Wine, 10½ oz
Item #531495
Mfg. #71083 ✦
H7¼" T2⅞"
B2¾" D3⅞"
Cs Pk 1 x 3 dz
Cs Wt 16.00 lb



Grand Savoie, 12 oz
Item #531698
Mfg. #71080 ✦
H7½" T3"
B3" D3⅞"
Cs Pk 1 x 2 dz
Cs Wt 13.00 lb



Grand Savoie, 15½ oz
Item #531650
Mfg. #51752 ✦
H8¼" T3¼"
B3" D3⅞"
Cs Pk 1 x 2 dz
Cs Wt 14.00 lb

EXCALIBUR



Arcoroc
Professional

Cardinal



Petite Cuvee, 13 oz
Item #531499
Mfg. #71093 ❖
H7" T2¾"
B3" D3¾"
Cs Pk 1 x 2 dz
Cs Wt 14.00 lb



Grand Cuvee, 13 oz
Item #531493
Mfg. #71081 ❖
H8½" T2¾"
B3" D3¾"
Cs Pk 1 x 2 dz
Cs Wt 14.00 lb



Banquet Goblet, 11½ oz
Item #531491
Mfg. #71078 ❖
H5¼" T3"
B2½" D3¾"
Cs Pk 1 x 3 dz
Cs Wt 18.00 lb



All Purpose Goblet, 11 oz
Item #531490
Mfg. #71076 ❖
H6¼" T2½"
B3" D3¾"
Cs Pk 1 x 3 dz
Cs Wt 18.00 lb



All Purpose Goblet, 14 oz
Item #531465
Mfg. #04757 ❖
H6¾" T2½"
B3" D3¾"
Cs Pk 1 x 2 dz
Cs Wt 15.00 lb



Margarita, 12 oz
Item #531702
Mfg. #15442
H6¾" T4¾"
B3" D4¾"
Cs Pk 1 x 1 dz
Cs Wt 8.00 lb



Cocktail, 5 oz
Item #531550
Mfg. #22760 ❖
H6" T3¾"
B2¾" D3¾"
Cs Pk 1 x 3 dz
Cs Wt 15.00 lb



Cocktail, 7½ oz
Item #531475
Mfg. #09232
H6¾" T4½"
B3" D4½"
Cs Pk 1 x 1 dz
Cs Wt 6.00 lb



Cocktail, 7½ oz
Item #531514
Mfg. #D2024 ❖
H6¾" T4½"
B3½" D4½"
Cs Pk 1 x 1 dz
Cs Wt 10.00 lb



Cocktail, 10 oz
Item #531500
Mfg. #79320
H7¼" T4¾"
B3" D4¾"
Cs Pk 1 x 1 dz
Cs Wt 10.00 lb



Cocktail, 10 oz
Item #531456
Mfg. #00213 ❖
H7¼" T4¾"
B3" D4¾"
Cs Pk 1 x 1 dz
Cs Wt 10.00 lb



Brandy, 12 oz
Item #531492
Mfg. #71079 ❖
H5" T2½"
B2½" D3½"
Cs Pk 1 x 2 dz
Cs Wt 11.00 lb



Brandy, 17 oz
Item #531552
Mfg. #23876
H5½" T2½"
B2½" D3¾"
Cs Pk 1 x 2 dz
Cs Wt 14.00 lb



Old Fashioned, 7 oz
Item #531532
Mfg. #20875 ❖
H3½" T3"
B2½" D3"
Cs Pk 1 x 3 dz
Cs Wt 14.00 lb



Old Fashioned, 9 oz
Item #531531
Mfg. #20874 ❖
H3¼" T3¼"
B2½" D3¼"
Cs Pk 1 x 3 dz
Cs Wt 17.00 lb



Old Fashioned, 10½ oz
Item #531530
Mfg. #20873 ❖
H3½" T3¾"
B2½" D3¾"
Cs Pk 1 x 3 dz
Cs Wt 20.00 lb



Footed Hi-Ball, 8 oz
Item #531498
Mfg. #71092 ❖
H5¼" T2¾"
B2½" D2¾"
Cs Pk 1 x 3 dz
Cs Wt 18.00 lb

TABLETOP

EXCALIBUR



Cardinal



Hi-Ball, 6 oz
Item #531529
Mfg. #20871 ❖
H4" T2½"
B1¾" D2½"
Cs Pk 1 x 3 dz
Cs Wt 15.00 lb



Hi-Ball, 8 oz
Item #531526
Mfg. #20869 ❖
H4¾" T2¾"
B1¾" D2¾"
Cs Pk 1 x 3 dz
Cs Wt 16.00 lb



Hi-Ball, 9 oz
Item #531524
Mfg. #20868 ❖
H4¾" T2¾"
B1¾" D2¾"
Cs Pk 1 x 3 dz
Cs Wt 18.00 lb



Hi-Ball, 10½ oz
Item #531512
Mfg. #20867 ❖
H5½" T2¾"
B2" D2¾"
Cs Pk 1 x 3 dz
Cs Wt 22.00 lb



Hi-Ball, 11 oz
Item #531511
Mfg. #20866 ❖
H5¼" T2¾"
B2" D2¾"
Cs Pk 1 x 3 dz
Cs Wt 22.00 lb



Beverage, 12½ oz
Item #531509
Mfg. #20865 ❖
H5½" T2¾"
B2" D2¾"
Cs Pk 1 x 3 dz
Cs Wt 23.00 lb



Beverage, 16 oz
Item #531508
Mfg. #20864 ❖
H6" T3½"
B2½" D3½"
Cs Pk 1 x 3 dz
Cs Wt 27.00 lb



Iced Tea, 16½ oz
Item #531689
Mfg. #12926 ❖
H7¾" T2¾"
B3" D3½"
Cs Pk 1 x 2 dz
Cs Wt 15.00 lb

CABERNET



Cordial, 2½ oz
Item #531619
Mfg. #47346 ⚡
H3½" T1½"
B1¾" D1½"
Cs Pk 1 x 4 dz
Cs Wt 12.00 lb



Cordial, 2¼ oz
Item #531527
Mfg. #E5358 ⚡
H5¼" T1¾"
B2" D1¾"
Cs Pk 1 x 2 dz
Cs Wt 5.00 lb



Port, 4 oz
Item #531701
Mfg. #14798 ⚡
H5½" T1¾"
B2" D2½"
Cs Pk 1 x 2 dz
Cs Wt 7.00 lb



Flute, 5¾ oz
Item #531633
Mfg. #48024 ⚡
H8¾" T2"
B2¼" D2¾"
Cs Pk 1 x 2 dz
Cs Wt 9.00 lb



Champagne Flute, 8 oz
Item #531513
Mfg. #D0796 ⚡
H9¾" T2"
B2¾" D2¾"
Cs Pk 1 x 2 dz
Cs Wt 10.00 lb



Tall Wine, 8½ oz
Item #531611
Mfg. #46978 ⚡
H7½" T2¼"
B2¾" D2¾"
Cs Pk 1 x 2 dz
Cs Wt 10.00 lb



Tall Wine, 10½ oz
Item #531649
Mfg. #50816 ⚡
H7¾" T2¾"
B3" D3¼"
Cs Pk 1 x 2 dz
Cs Wt 12.00 lb



Tall Wine, 12 oz
Item #531609
Mfg. #46973 ⚡
H8" T2½"
B3" D3¼"
Cs Pk 1 x 2 dz
Cs Wt 13.00 lb



Tall Wine, 16 oz
Item #531607
Mfg. #46961 ⚡
H8¾" T2¾"
B3½" D3½"
Cs Pk 1 x 2 dz
Cs Wt 15.00 lb



Tall Wine, 19¾ oz
Item #531604
Mfg. #46888 ⚡
H9½" T2¾"
B3¼" D3¼"
Cs Pk 1 x 2 dz
Cs Wt 17.00 lb

CABERNET



TABLETOP



Young Wine, 12 oz
Item #531522
Mfg. #E2788 :
H8" T2¼"
B3⅜" D4"
Cs Pk 1 x 2 dz
Cs Wt 13.00 lb



Young Wine, 16 oz
Item #531525
Mfg. #E2790 :
H8½" T2⅝"
B3¼" D3½"
Cs Pk 1 x 2 dz
Cs Wt 17.00 lb



Young Wine, 19½ oz
Item #531523
Mfg. #E2789 :
H8⅞" T2¾"
B3⅜" D3¾"
Cs Pk 1 x 2 dz
Cs Wt 17.00 lb



Ballon Wine, 12 oz
Item #531615
Mfg. #47019 :
H7⅜" T2⅞"
B3" D3⅝"
Cs Pk 1 x 2 dz
Cs Wt 11.00 lb



Ballon Wine, 16 oz
Item #531613
Mfg. #47017 :
H7¾" T3"
B3" D3⅞"
Cs Pk 1 x 2 dz
Cs Wt 12.00 lb



Ballon Wine, 20 oz
Item #531617
Mfg. #47026 :
H8¼" T3⅜"
B3¼" D4⅜"
Cs Pk 1 x 2 dz
Cs Wt 16.00 lb



Ballon Wine, 24 oz
Item #531707
Mfg. #46981 :
H8½" T3⅞"
B3¼" D4½"
Cs Pk 1 x 2 dz
Cs Wt 19.00 lb



Tulipe, 25¼ oz
Item #531510
Mfg. #D0795 :
H10" T3"
B3⅞" D3¾"
Cs Pk 1 x 1 dz
Cs Wt 9.00 lb



Champagne Coupe, 10 oz
Item #531515
Mfg. #D6140 :
H6¾" T4⅞"
B2⅞" D4⅞"
Cs Pk 1 x 2 dz
Cs Wt 12.00 lb



Cocktail, 7½ oz
Item #531479
Mfg. #58001
H6¾" T4½"
B3" D4½"
Cs Pk 1 x 2 dz
Cs Wt 14.00 lb



Cocktail, 10 oz
Item #531485
Mfg. #62449 :
H7½" T4¾"
B3" D4¾"
Cs Pk 1 x 2 dz
Cs Wt 15.00 lb



Margarita, 15½ oz
Item #531711
Mfg. #62447 :
H7½" T4⅞"
B3" D4⅞"
Cs Pk 1 x 2 dz
Cs Wt 17.00 lb



Brandy, 13¼ oz
Item #531555
Mfg. #E9336 :
H5⅞" T2½"
B3¼" D3⅞"
Cs Pk 1 x 16 ea
Cs Wt 8.00 lb



All Purpose, 13½ oz
Item #531568
Mfg. #G3573 :
H6⅞" T2⅞"
B3⅞" D3⅞"
Cs Pk 1 x 2 dz
Cs Wt 13.00 lb



Iced Tea, 16 oz
Item #531566
Mfg. #G3570 :
H7⅞" T2⅞"
B3⅞" D3⅞"
Cs Pk 1 x 2 dz
Cs Wt 15.00 lb

CABERNET



Beverage, 11½ oz
Item #531602
Mfg. #46774
H5" T2½"
B2¼" D2¼"
Cs Pk 1 x 4 dz
Cs Wt 28.00 lb



Rocks, 10½ oz
Item #531478
Mfg. #10007 ❖
H3¼" T3¼"
B2¾" D3¾"
Cs Pk 1 x 3 dz
Cs Wt 24.00 lb



Double Old Fashioned, 14 oz
Item #531488
Mfg. #17197 ❖
H3½" T3½"
B2¾" D3½"
Cs Pk 1 x 1 dz
Cs Wt 9.00 lb



Hi-Ball, 7¾ oz
Item #531705
Mfg. #46697 ❖
H4½" T2½"
B2" D2¾"
Cs Pk 1 x 4 dz
Cs Wt 24.00 lb



Cooler, 17 oz
Item #531502
Mfg. #17198 ❖
H5½" T2¾"
B2½" D3½"
Cs Pk 1 x 1 dz
Cs Wt 10.00 lb

MILLESIME



Flute, 6¼ oz
Item #531537
Mfg. #E8520 :
H8¾" T1¾"
B2¾" D2¾"
Cs Pk 1 x 2 dz
Cs Wt 10.00 lb



Wine, 10¼ oz
Item #531536
Mfg. #E8519 :
H7¼" T2½"
B2¾" D3¼"
Cs Pk 1 x 2 dz
Cs Wt 13.00 lb



Wine, 15¼ oz
Item #531535
Mfg. #E8518 :
H8¾" T2¾"
B3¼" D3¾"
Cs Pk 1 x 2 dz
Cs Wt 15.00 lb



Wine, 19¼ oz
Item #531528
Mfg. #E8516 :
H8¾" T3"
B3¼" D3¾"
Cs Pk 1 x 1 dz
Cs Wt 9.00 lb



ARTIC



Wine, 8 oz
Item #531471
Mfg. #57286 ❖
H5½" T3"
B2½" D3"
Cs Pk 1 x 4 dz
Cs Wt 29.00 lb



Goblet, 10½ oz
Item #531655
Mfg. #57070 ❖
H5¼" T3½"
B2½" D3½"
Cs Pk 1 x 4 dz
Cs Wt 33.00 lb



Juice, 6 oz
Item #531652
Mfg. #53664 ❖
H3¼" T2¼"
B1½" D2¼"
Cs Pk 1 x 4 dz
Cs Wt 17.00 lb



Old Fashioned, 10½ oz
Item #531469
Mfg. #57282 ❖
H3¾" T3¾"
B2¾" D3¾"
Cs Pk 1 x 4 dz
Cs Wt 31.00 lb



Beverage, 12½ oz
Item #531654
Mfg. #57069 ❖
H5½" T2¾"
B2¼" D2¾"
Cs Pk 1 x 4 dz
Cs Wt 39.00 lb

GRANITE®



Cardinal

TABLETOP



Tall Rocks, 9 oz
Item #531599
Mfg. #44032 ❖ □
H3 3/8" T3 3/8"
B2 3/8" D3 3/8"
Cs Pk 1 x 3 dz
Cs Wt 25.00 lb



Beverage, 10 1/2 oz
Item #531570
Mfg. #29879 ❖ □
H5 1/2" T2 7/8"
B2 7/16" D2 7/8"
Cs Pk 1 x 4 dz
Cs Wt 41.00 lb



Beverage, 12 oz
Item #531704
Mfg. #43279 ❖ □
H4 7/8" T3 1/4"
B2 5/8" D3 1/4"
Cs Pk 1 x 3 dz
Cs Wt 31.00 lb



Beverage, 14 oz
Item #531579
Mfg. #43280 ❖ □
H5 1/8" T3 1/2"
B2 3/4" D3 1/2"
Cs Pk 1 x 3 dz
Cs Wt 36.00 lb



Beverage, 16 oz
Item #531581
Mfg. #43281 ❖ □
H6 3/8" T3 3/8"
B2 1/2" D3 3/8"
Cs Pk 1 x 3 dz
Cs Wt 45.00 lb

ISLANDE



Iced Tea, 22 oz
Item #531583
Mfg. #43282 ❖ □
H7" T3 3/4"
B2 3/4" D3 3/4"
Cs Pk 1 x 2 dz
Cs Wt 37.00 lb



Cordial, 2 1/4 oz
Item #531458
Mfg. #01005
H4 1/8" T1 1/2"
B1 3/8" D1 1/2"
Cs Pk 1 x 4 dz
Cs Wt 12.00 lb



Whiskey, 3 1/4 oz
Item #531467
Mfg. #05425
H3 7/16" T2"
B1 7/8" D2"
Cs Pk 1 x 4 dz
Cs Wt 19.00 lb



Old Fashioned, 7 oz
Item #531577
Mfg. #40383
H3 1/4" T2 3/4"
B2 5/8" D2 3/4"
Cs Pk 1 x 4 dz
Cs Wt 28.00 lb



Old Fashioned, 8 1/2 oz
Item #531699
Mfg. #12652
H3 3/8" T3 1/8"
B3" D3 3/8"
Cs Pk 1 x 4 dz
Cs Wt 36.00 lb



Old Fashioned, 10 oz
Item #531506
Mfg. #20750
H3 3/8" T3 1/8"
B3" D3 3/8"
Cs Pk 1 x 4 dz
Cs Wt 41.00 lb



Hi-Ball, 10 oz
Item #531642
Mfg. #48722
H5 5/8" T2 1/2"
B2 1/4" D2 1/2"
Cs Pk 1 x 4 dz
Cs Wt 32.00 lb



Hi-Ball, 11 oz
Item #531575
Mfg. #40334
H6 1/2" T2 3/8"
B2 1/8" D2 3/8"
Cs Pk 1 x 4 dz
Cs Wt 33.00 lb



Cooler, 13 oz
Item #531574
Mfg. #40326
H6 3/4" T2 1/2"
B2 1/4" D2 1/2"
Cs Pk 1 x 4 dz
Cs Wt 35.00 lb



❖ Fully Tempered □ Stackable

Sold in case pack only.

CASABLANCA

Elemental

Cardinal



Beverage, 12¼ oz
Item #531676
Mfg. #703225 +
H5" T3½"
B2½"
Cs Pk 1 x 3 dz
Cs Wt 31.00 lb



Beverage, 14 oz
Item #531670
Mfg. #218416 +
H5¼" T3½"
B2½"
Cs Pk 1 x 3 dz
Cs Wt 33.00 lb



Cooler, 12¼ oz
Item #531675
Mfg. #664625 +
H6¼" T3¼"
B2¼"
Cs Pk 1 x 3 dz
Cs Wt 31.00 lb



Cooler, 16¼ oz
Item #531677
Mfg. #896402 +
H6½" T3½"
B2"
Cs Pk 1 x 3 dz
Cs Wt 39.00 lb



Rocks, 4¾ oz
Item #531671
Mfg. #364624 +
H3" T3"
B2"
Cs Pk 1 x 3 dz
Cs Wt 16.00 lb



Rocks, 7 oz
Item #531672
Mfg. #481322 +
H3½" T3¼"
B2¼"
Cs Pk 1 x 3 dz
Cs Wt 17.00 lb



Rocks, 8¼ oz
Item #531673
Mfg. #490249 +
H3¾" T3½"
B2¼"
Cs Pk 1 x 3 dz
Cs Wt 22.00 lb



Rocks, 9 oz
Item #531669
Mfg. #101231 +
H4" T3½"
B2¼"
Cs Pk 1 x 3 dz
Cs Wt 22.00 lb



Rocks, 9¾ oz
Item #531674
Mfg. #660962 +
H5" T3¼"
B2½"
Cs Pk 1 x 3 dz
Cs Wt 32.00 lb

ROOM TUMBLER



Tumbler, 8¾ oz
Item #531569
Mfg. #29811
H3¾" T3"
B2¾" D3"
Cs Pk 1 x 3 dz
Cs Wt 21.00 lb

SHETLAND



Old Fashioned, 8½ oz
Item #531505
Mfg. #79747
H3½" T3½"
B2¾" D3½"
Cs Pk 1 x 4 dz
Cs Wt 30.00 lb



Old Fashioned, 10½ oz
Item #531521
Mfg. #E1907
H3¾" T3¾"
B2½" D3¾"
Cs Pk 1 x 4 dz
Cs Wt 36.00 lb



Hi-Ball, 12 oz
Item #531503
Mfg. #79728
H5½" T3¼"
B2" D3¼"
Cs Pk 1 x 4 dz
Cs Wt 33.00 lb



Hi-Ball, 14 oz
Item #531501
Mfg. #79698
H5¾" T3¾"
B2½" D3¾"
Cs Pk 1 x 4 dz
Cs Wt 36.00 lb

ARISTOCRAT



Old Fashioned, 11 oz
Item #531651
 Mfg. #53224
 H3½" T3⅜"
 B3" D3⅜"
 Cs Pk 1 x 3 dz
 Cs Wt 27.00 lb

NONIC



Tumbler, 10 oz
Item #531589
 Mfg. #43716 ✦ □
 H4½" T2⅜"
 B2⅜" D2⅞"
 Cs Pk 1 x 4 dz
 Cs Wt 16.00 lb



Tumbler, 16 oz
Item #531538
 Mfg. #E8792 ✦ □
 H5½" T3⅞"
 B2½" D3⅜"
 Cs Pk 1 x 4 dz
 Cs Wt 30.00 lb



Tumbler, 20 oz
Item #531645
 Mfg. #49357 ✦ □
 H5⅝" T3⅞"
 B2⅞" D3⅜"
 Cs Pk 1 x 4 dz
 Cs Wt 35.00 lb

PRYSM



Rocks, 9 oz
Item #531519
 Mfg. #E1515 ✦
 H3½" T3⅞"
 B2¾" D3⅞"
 Cs Pk 1 x 4 dz
 Cs Wt 32.00 lb



Cooler, 16 oz
Item #531520
 Mfg. #E1516 ✦
 H5¾" T3¾"
 B2¾" D3¾"
 Cs Pk 1 x 4 dz
 Cs Wt 48.00 lb

ARTISAN



Artisan Circle Textured, 16 oz
Item #531684
 Mfg. #1012317 +
 H6⅞" T3⅞"
 B2⅞" D3⅞"
 Cs Pk 1 x 1 dz
 Cs Wt 16.00 lb



Artisan Square Textured, 16 oz
Item #531686
 Mfg. #1012318 +
 H6⅞" T3⅞"
 B2⅞" D3⅞"
 Cs Pk 1 x 1 dz
 Cs Wt 16.00 lb



Artisan Line Textured, 16 oz
Item #531683
 Mfg. #1012316 +
 H6⅞" T3⅞"
 B2⅞" D3⅞"
 Cs Pk 1 x 1 dz
 Cs Wt 16.00 lb



Artisan Textured Assortment, 16 oz
Item #531688
 Mfg. #1012319 +
 H6⅞" T3⅞"
 B2⅞" D3⅞"
 Cs Pk 1 x 1 dz
 Cs Wt 16.00 lb



PUB & MIXING



Pub Glass, 16 oz
Item #531504
Mfg. #19343 ✦
H5¾" T3½"
B2¾" D3½"
Cs Pk 1 x 2 dz
Cs Wt 23.00 lb



Mixing/Cooler, 14 oz
Item #531680
Mfg. #165629 ✦
H6" T3½"
B2½"
Cs Pk 1 x 2 dz
Cs Wt 31.00 lb



Mixing, 16 oz
Item #531682
Mfg. #442116 ✦
H6" T3½"
B2½"
Cs Pk 1 x 2 dz
Cs Wt 26.00 lb

CERVOISE



Goblet, 10½ oz
Item #531470
Mfg. #07134
H6½" T2¾"
B2⅞" D2⅞"
Cs Pk 1 x 2 dz
Cs Wt 11.00 lb



Goblet, 16½ oz
Item #531468
Mfg. #07131
H7½" T2¾"
B2⅞" D3¼"
Cs Pk 1 x 2 dz
Cs Wt 15.00 lb

PILSNERS



Linz, 13½ oz
Item #531559
Mfg. #25263
H8⅞" T2¾"
B2⅞" D2¾"
Cs Pk 1 x 2 dz
Cs Wt 17.00 lb



Linz, 23 oz
Item #531563
Mfg. #25275
H8½" T3⅞"
B3¼" D3⅞"
Cs Pk 1 x 2 dz
Cs Wt 28.00 lb

CIN CIN



Tall Beer, 14 oz
Item #531679
Mfg. #521284
H10" T2¾"
B3¼"
Cs Pk 1 x 2 dz
Cs Wt 25.00 lb

SHOT GLASS



Tall Square, 2¾ oz
Item #531507
Mfg. #C3966 ✦
H3¾" T1⅞"
B1⅞" D1⅞"
Cs Pk 1 x 6 dz
Cs Wt 27.00 lb

STACKING ASHTRAYS



White, 3¼" dia
Item #531708
Mfg. #51254
H1¼" T3¼"
B2⅞" D3¼"
Cs Pk 1 x 2 dz
Cs Wt 8.00 lb



Black, 3¼" dia
Item #531710
Mfg. #55878
H1¼" T3¼"
B2⅞" D3¼"
Cs Pk 1 x 2 dz
Cs Wt 8.00 lb

SEABREEZE DESSERT PLATE

- Features fluid-like swirls reminiscent of ocean waves
- Fully tempered
- 7½" dia

Item #531489
Mfg. #62899
Cs Pk 1 x 6 pc
Cs Wt 16.00 lb
Sold in case pack only.



✦ Rim-Tempered ✦ Fully Tempered

Sold in case pack only.



ARCADE BOWLS

- Attractive with a variety of uses
- Stack for easy, efficient storage
- Fully tempered



Item #	Mfg. #	Description	Cs Pk	Cs Wt
531646	49698	Bowl, 4", 5½ oz	1 x 3 dz	9.00 lb
531457	00556	Bowl, 5", 11 oz	1 x 12 dz	51.00 lb

Sold in case pack only.

ROC

- Fully tempered, extra resistant
- Clear



Item #	Mfg. #	Description	Cs Pk	Cs Wt
531462	01166	Plate, Dessert, 6"	1 x 3 dz	16.00 lb
531461	01158	Plate, Salad, 7½"	1 x 3 dz	22.00 lb
531460	01141	Plate, Dinner, 9⅞"	1 x 3 dz	35.00 lb
531459	01133	Plate, Soup/Deep Salad, 9⅞", 10 oz	1 x 3 dz	35.00 lb
531464	01273	Bowl, 4⅞", 10 oz	1 x 3 dz	18.00 lb
531463	01224	Compote, 5½", 10 oz	1 x 6 dz	37.00 lb

Sold in case pack only.



STACK BOWLS

- Attractive with a variety of uses
- Stack for easy, efficient storage
- Fully tempered, extra resistant



Item #	Mfg. #	Description	Cs Pk	Cs Wt
531541	E9155	Bowl, 2⅓", 1¼ oz	1 x 3 dz	4.00 lb
531543	E9156	Bowl, 3", 2¼ oz	1 x 3 dz	7.00 lb
531545	E9157	Bowl, 3½", 5 oz	1 x 3 dz	9.00 lb
531547	E9158	Bowl, 4⅞", 7½ oz	1 x 3 dz	13.00 lb
531551	E9159	Bowl, 4¾", 12 oz	1 x 3 dz	20.00 lb
531553	E9160	Bowl, 5½", 21 oz	1 x 3 dz	23.00 lb
531480	10027	Bowl, 6⅞", 39 oz	1 x 2 dz	25.00 lb
531476	09994	Bowl, 10¼", 144 oz	1 x 6 pc	18.00 lb
531560	G2102	Bowl, 8", 64 oz	1 x 6 pc	10.00 lb
531558	G2100	Bowl, 9", 94 oz	1 x 6 pc	14.00 lb

Sold in case pack only.

FLEUR

- Frosted flower design to enhance any tabletop
- Fully tempered



Item #	Mfg. #	Description	Cs Pk	Cs Wt
531580	G4315	Plate, Dessert, 7½"	1 x 3 dz	22.00 lb
531472	08781	Compote, 5¾", 10 oz	1 x 4 dz	22.00 lb
531517	D9016	Bowl, 5", 10½ oz	1 x 1 dz	11.00 lb
531539	E8883	Bowl, 7", 32 oz	1 x 6 pc	5.00 lb
531518	D9070	Bowl, 9", 70 oz	1 x 4 pc	22.00 lb
531643	48728	Soup/Deep Salad, 8", 15 oz	1 x 3 dz	33.00 lb

Sold in case pack only.



GLASSWARE CODING

Each manufacturer has special individual processes used to treat their glassware. The following is a guide to the symbols used at the foot of the page throughout the preceding section designating the process used.

LIBBEY® GLASSWARE – PAGES 3-31

+ DuraTuff®

A special thermal afterprocess for “pressed” glass. Performed only on the upper portion of pressed tumblers and stemware to increase their resistance to thermal and mechanical shock.



★ Heat-Treated

A secondary process on “blown” glass. After the glass is formed a special heating and rapid cooling process is performed on the upper portion to increase resistance to thermal and mechanical shock. Recommended for fast service cycle operations.



● Safedge® Rim Guarantee

If the rim of any glass covered by this guarantee chips it will be replaced or the price refunded when returned to the dealer (does not cover breakage).



■ Safedge® Rim and Foot Guarantee

If the rim or foot of any one-piece stemware item chips it will be replaced or the price refunded when returned to the dealer (does not cover breakage).



▲ Finedge®

Features a minimum bead on the edge. This finely rimmed glassware brings subtle beauty to any establishment.



✘ Sheer Rim/D.T.E™

Features a beadless edge which is first cracked-off then polished to produce a fine, yet durable edge. Guaranteed against breakage of the rim.



◆ Luigi Bormioli

Developed to provide a superior, resonant blown glass in a quality and purity rivaling that of lead crystal.



✦ SON.hyx Rim and Foot Guarantee

If the rim or foot chips it will be replaced when returned to the manufacturer (does not cover breakage).



✦ Hand Blown

Manufactured by hand, giving the glass unique individual characteristics.

ANCHOR® GLASSWARE – PAGES 32-41

■ Sure Guard™ Guarantee

Guarantees the entire foodservice line against chipping. If the rim of a tumbler or the foot or rim of a piece of stemware chips in normal use, it will be replaced or the price refunded when returned to the dealer (does not cover breakage).

+ Rim-Tempered

Heat is concentrated on the rim area, followed by a cooling process which allows for a stronger, more durable product.

ABBREVIATIONS FOR DIMENSIONS

- H** represents Height
- T** represents Top Diameter
- B** represents Bottom Diameter
- D** represents Maximum Diameter

CARDINAL GLASSWARE – PAGES 42-50

✦ Fully Tempered

Up to 5 times more resistant to breakage. Offers increased strength and safety for handlers, without the loss of style and elegance.



✦ Kwarx Advanced Material

Revolutionary material created specifically to allow sheer rim designs to obtain extreme strength against chipping, breakage, scratching, and is guaranteed for up to 2,000 industrial dishwashing cycles. Completely transparent, making it perfect for tasting quality glassware.



+ Rim-Tempered

Adds strength and durability to affordability in the Elemental offering.

□ Stackable

Especially designed for stacking.



Traex Warewashing Racks Equivalency Chart

Catalog Page #	Libbey Mfg. #	Catalog Item #	Rack Catalog Item #
24	13	399411	431489
24	14	388101	431489
24	15	372438	431490
24	18	370542	431493
24	19	369375	431493
21	44	372845	457781
23	48	369579	457781
21	53	369271	457776
21	53/11680	442295	457776
21	96	369357	431490
21	96/11680	440835	431490
19	123	455745	457781
19	124	370318	457776
19	125	456252	457776
19	126	388102	431490
19	127	446314	457776
19	128	388689	457770
19	132	457012	457776
19	133	388107	431490
20	135	465016	457776
19	139	369661	457780
19	151	370505	457781
23	155	370511	457781
19	158	370618	431489
19	159	456253	431490
19	161	370596	431490
19	170	370868	457780
19	172	455753	431490
24	176	370161	431490
24	178	451267	431490
24	179	402449	431490
24	181	452922	431489
24	183	370210	431493
25	194	370216	431493
15	217	489927	457770
15	221	458329	457776
15	222	458330	457770
20	223	444512	457781
15	224	461169	N/A
20	225	388103	431490
20	226	388109	431490
20	227	370342	457770
20	232	456251	457781
25	247	488384	457771
20	259	388104	431490
15	400	395258	457780
15	401	435120	457780
15	402	442425	457783
15	403	434201	451539
31	718	370103	457781
31	719	371313	431490
30	763	369352	429337
31	789	370193	431493
31	795	370324	459237
25	1604	480549	457771
25	1610	368644	457771
25	1611	386504	459237
25	1623	406181	457771
30	1965	369676	457776
16	2212	431878	431495
23	2303	370260	457781

Catalog Page #	Libbey Mfg. #	Catalog Item #	Rack Catalog Item #
14	2310	369513	431490
14	2318	370124	457781
14	2325	369578	457781
14	2328	369526	457770
14	2338	369233	457770
14	2339	369256	457770
14	2349	370123	457781
14	2359	370138	431490
14	2369	369536	431490
12	2392	391456	457770
25	2478	370881	459237
13	2481	369524	457776
13	2484	370518	457770
13	2485	369270	457770
13	2486	369582	431489
13	2488	369446	431489
13	2489	369441	457770
30	2824	370867	431494
12	3010	394369	431495
12	3011	370219	459237
11	3014	369641	431495
11	3056	370455	431493
11	3057	368794	457771
12	3060	406636	459237
11	3064	370539	431493
11	3065	370312	431493
12	3088	373776	431490
12	3096	385990	457779
13	3211	455342	431489
13	3212	368805	431495
13	3228	369293	431493
13	3264	370446	431493
12	3312	370578	431489
12	3364	369438	431489
15	3402	369442	459237
15	3403	369601	429336
15	3407	386111	429336
15	3408	370162	429336
14	3537	370253	431490
14	3556	370499	431494
16	3616	369420	457771
16	3617	370184	457771
16	3623	370382	457771
23	3701	433733	457770
5	3702	369631	457776
5	3704	369332	457770
5	3705	369167	431491
5	3708	369522	431491
5	3709	370327	431491
5	3711	452469	431489
5	3712	452220	431489
7	3715	369229	431493
7	3716	370115	431493
7	3717	369172	431495
7	3721	369195	431489
5	3725	370899	431494
5	3727	438414	431494
5	3728	452225	431494
5	3730	453268	431493
6	3733	417899	431491
6	3736	453245	431490

TABLETOP

Rack extenders are available on a special order basis as needed. N/A ask your customer service for specialized rack.

Traex Warewashing Racks Equivalency Chart

Catalog Page #	Libbey Mfg. #	Catalog Item #	Rack Catalog Item #
6	3737	450264	431490
5	3746	454341	457770
5	3747	453264	457770
7	3750	372891	457771
5	3756	452223	431489
4	3757	368727	431489
4	3764	452222	431489
4	3765	452921	431494
4	3766	368807	431490
4	3769	455743	431490
6	3771	369269	431491
6	3773	369160	457770
6	3777	368674	457770
6	3779	370183	431495
6	3788	450753	457781
6	3790	370412	457781
6	3792	370240	457781
6	3793	370494	457781
6	3794	369555	431494
6	3795	369175	457779
7	3796	369308	457771
26	3810	369540	431494
26	3812	370269	431493
26	3815	370281	457771
13	3820	370497	431489
13	3823	369502	457779
13	3824	370172	457780
13	3825	370416	457770
13	3826	370271	457781
13	3827	370167	431491
13	3828	370097	457779
12	3911	370519	431493
12	3914	370785	431489
12	3915	369460	431493
12	3957	369577	431493
12	3964	370864	431489
12	3965	453249	431493
12	3966	370241	431490
12	3969	370114	431489
12	3996	370211	431490
25	4803	447742	431492
27	5001	369197	459237
27	5010	369393	457783
26	5011	370180	457783
26	5012	369519	457783
27	5016	370582	457783
27	5018	369610	457783
27	5019	369529	457783
27	5020	369154	457783
27	5021	370603	457783
27	5027	382015	431491
23	5030	370396	457781
23	5031	370181	457781
30 & 135	5037	369547	457781
31	5044	369408	429338
30 & 135	5045	369557	457781
30	5065	369203	457770
27	5092	369389	457783
29	5101	369675	457770
30	5102	450757	429339
30	5103	434202	457780

Catalog Page #	Libbey Mfg. #	Catalog Item #	Rack Catalog Item #
24	5109	370248	457781
29	5110	388105	431493
29	5115	369417	431491
29	5118	369365	457783
29	5119	369334	429340
23	5120	370458	457781
23	5121	370337	457781
23	5122	369443	457781
23	5126	370343	457781
23	5127	371204	457781
23	5128	370107	457781
20	5130	369574	457776
20	5131	453590	457776
23	5135	370284	457776
22	5137	370311	431495
23	5138	370178	457776
22	5139	385622	431489
31	5143	368642	429338
31	5154	369163	429338
31	5156	369380	429338
30	5160	369404	457776
30	5161	370177	457770
30	5162	369180	457770
31	5164	368651	429338
31	5165	369486	429338
31	5172	369619	429338
28	5201	369456	457770
26	5202	369217	457783
26	5203	369228	457783
26	5205	368808	457783
27	5206	368692	457783
25	5210	369497	431491
25	5212	369570	431491
28	5213	370291	457780
30 & 135	5221	369653	457781
30 & 87	5258	369183	457770
31	5260	369378	429336
27	5262	369447	429336
31	5265	369189	429338
27	5272	369161	457783
27	5273	370249	457783
28	5293	370250	431491
28	5294	369181	431491
28	5295	368655	431491
26	5297	369359	457783
26	5298	369343	457783
28	5304	370538	431491
26	5307	369669	431491
26	5309	369218	457783
29	5310	369550	431493
29	5314	369278	431491
29	5315	370173	431491
30	5317	370154	429338
27	5355	370587	457783
26	5360	373236	457783
26	5362	387220	457783
26	5364	381932	457783
30 & 87	5460	369537	429336
25	6425	369650	457779
8	7500	406634	457771
8	7502	406359	459237

Rack extenders are available on a special order basis as needed.

Traex Warewashing Racks Equivalency Chart

Catalog Page #	Libbey Mfg. #	Catalog Item #	Rack Catalog Item #
8	7503	401940	431495
8	7504	406633	459237
9	7505	406362	459237
16	7507	406635	457783
8	7508	402722	457771
8	7509	402725	431495
8	7510	402726	457771
16	7511	410327	457783
9	7512	411639	457783
9	7513	425775	431491
8	7551	411651	459237
8	7552	439103	457771
16	7700	410673	457783
15	8089	369328	431490
10	8402	370374	457770
10	8405	370365	457780
10	8411	369252	431489
11	8412	368634	457771
17	8413	370165	457771
10	8414	369173	431491
11	8415	369205	431495
17	8416	369657	459237
17	8417	369451	457783
17	8418	368718	431495
17	8420	370204	459237
17	8422	369430	457783
17	8423	368660	457783
11	8425	369223	457771
17	8427	369655	457783
11	8428	371316	457783
11	8429	369201	457783
11	8454	369264	431489
11	8455	368704	431491
10	8456	453258	431493
11	8464	452221	431494
10	8466	369370	431490
10	8470	369215	431490
10	8471	369395	431489
10	8472	453592	431493
11	8476	368724	457779
11	8477	369326	431494
17	8480	368711	457783
17	8485	432444	457783
11	8495	377479	431494
10	8764	370237	431494
10	8795	369556	457779
16	8876	369421	431491
16	8883	413030	457783
10	8941	369672	431493
10	8941	369672	431493
10	8956	369498	431489
10	8978	371309	457783
10	8995	369468	457779
7	08743/07	472348	459237
7	08745/07	472332	459237
22	15141	387219	431489
3	15231	369184	457770
3	15232	369288	457770
3	15233	370160	457780
3	15235	369156	431489
3	15236	369171	457770

Catalog Page #	Libbey Mfg. #	Catalog Item #	Rack Catalog Item #
3	15237	368721	457770
3	15238	368799	431489
3	15239	369198	457776
3	15240	368708	457770
3	15241	369243	457770
3	15242	368715	457770
3	15243	368694	457780
3	15244	368798	431489
3	15245	371321	457770
4	15246	370267	431489
4	15247	368714	431495
3	15248	369240	457770
3	15249	369505	457770
4	15253	368697	431495
3	15256	388106	431493
29	15411	370188	429338
29	15412	369323	429338
28	15427	370532	429338
4	15429	389014	431493
19	15430	371342	457770
18	15431	370086	457776
18	15432	370425	457770
19	15433	370381	457770
19	15434	369429	457770
19	15435	369674	457780
19	15436	369190	457770
19	15437	369225	457770
30 & 90	15445	369432	429337
30 & 90	15446	369260	428340
30 & 90	15447	369470	457770
14	15451	369553	457776
14	15453	369508	457776
14	15454	369174	457770
14	15456	369285	431490
14	15457	369231	457770
14	15458	368699	431489
14	15459	369467	431489
14	15463	370391	431490
14	15464	370169	431489
14	15465	368665	431489
18	15477	388112	431489
17	15478	370358	431489
18	15479	379369	431489
17	15480	451027	457770
17	15481	369341	457770
17	15482	455744	457780
17	15483	369169	431489
17	15485	370601	431490
29	15500	370395	429338
28	15507	370095	429338
22	15585	411731	457770
22	15588	411733	431489
18	15603	370270	431489
18	15605	388100	431489
18	15640	370223	457770
18	15641	370427	431489
18	15642	370179	431491
18	15643	369560	431495
25	15646	426122	457780
4	15651	369608	431493
4	15652	369535	431489

Rack extenders are available on a special order basis as needed.

Traex Warewashing Racks Equivalency Chart

TABLETOP

Catalog Page #	Libbey Mfg. #	Catalog Item #	Rack Catalog Item #
4	15654	369435	431489
4	15656	370189	457770
4	15659	370875	457770
4	15661	370360	457770
3	15665	390501	451539
4	15673	406640	457771
18	15709	451129	457770
18	15710	451868	457770
18	15711	459085	431489
18	15712	460266	457780
18	15713	451127	431489
18	15714	460569	431493
18	15715	450509	431493
18	15720	475965	431493
22	15722	437931	431495
20	23106	386805	431490
20	23186	452023	457776
20	23236	449713	457776
20	23256	454343	457776
20	23286	458820	457776
20	23386	455335	457770
20	23396	370399	457780
20	23596	455405	431490
21	32802	370352	431493
16	37179	370569	431493
16	37339	411567	431495
16	37719	369646	431491
16	37799	369603	431495
135	70017	379625	457781
30 & 135	70022	369414	457781
15	70855	420879	457780
30	75305	370137	457776
31	97000	368680	459237
31	97001	369479	457771
27	97036	370148	457783
24	97038	370120	457776
30 & 135	97052	369305	457781
27	97084	369649	431491
27	97085	369422	431491
25	1722471	371399	457783
20	1767591	376565	457770
25	1785473	375984	457783
24	1787386	429127	431489
28	1788490	417894	429338
28	1788491	417635	429338
31	9520003	381990	429336
31	9520004	370310	429336
15	9570101	370558	429336
20	9860594	369549	431489
23	9862324	377096	457781
24	1240HT	388110	431493
24	1176HT	370564	431490
24	1178HT	452022	431490
24	1181HT	452226	431489
24	1183HT	370457	431493
25	1242HT	419542	459237
21	1450HT	370482	457776
21	1451HT	370475	431490
21	1453HT	428901	431490
21	1454HT	388111	431490
25	14801HT	369220	431489

Catalog Page #	Libbey Mfg. #	Catalog Item #	Rack Catalog Item #
25	14806HT	370174	431489
22	1637HT	369678	431495
22	1639HT	369193	431489
23	1650SR	370228	457781
20	1654SR	370135	457776
20	1660SR	370225	457770
20	1661SR	370145	431490
21	1713HT	388099	431493
21	171B	370390	431489
22	1906HT	369209	431490
22	1910HT	458817	457776
22	1917HT	369476	457776
22	29011HT	369364	457776
22	29211HT	369347	457776
22	29411HT	458822	431490
22	29511HT	463668	457776
22	29811HT	460213	431489
16	3619JS	369262	431491
16	3620JS	369635	431495
16	3649LS	370316	457783
6	3752HT	453254	431489
23	5120A0007	370232	457781
23	5121S0711	370134	457781
23	5122S0709	369350	457781
23	5126A0007	369545	457781
23	5126S0711	370205	457781
23	5127S0710	371205	457781
23	5127S0711	369337	457781
23	5135S0617	370191	457781
28	5213B	370443	502152
21	539HT	370438	431495
21	606HT	452224	431490
21	610HT	369489	457776
21	618HT	447746	457776
21	633HT	369425	457781
9	7510SR	451172	457771
9	7555SR	411641	459237
16	7700BS	413395	457783
19	814CD	370389	431490
19	817CD	370366	431489
9	8513SR	415853	431489
9	8515SR	370287	431495
9	8541SR	370535	431489
9	8555SR	370197	431489
9	8556SR	370345	431489
9	8564SR	370565	431494
9	8565SR	370529	431493
9	8572SR	370357	431493
9	8573SR	370562	431493
9	8588SR	370274	431490
19	916CD	369405	457770
20	9171CD	369221	457770
19	917CD	371312	457770
8	C145ZX	374020	457771
7	C189ZX	371352	451539
7	C211ZX	376195	451539
8	C269ZX	440803	457771
7	C82ZX	433415	457771
8	PM514ZX	374968	457771
8	PM515ZX	377061	457770
8	PM521ZX	374970	457770

Rack extenders are available on a special order basis as needed.

Cambro Warewashing Racks Equivalency Chart

Catalog Page #	Anchor Mfg. #	Catalog Item #	Rack Catalog Item #
35	100-00-01	506969	458145
35	100-00-02	531438	432227
35	100-00-07	506970	458147
35	100-00-09	523406	458147
35	100-00-12	523405	458147
35	100-00-15	523408	458674
35	100-00-16	516752	458674
35	100-00-35	518198	458145
35	100-00-37	506971	458145
35	283-00-11	530774	458151
40	350-00-10	531256	458147
40	350-00-46	523399	458674
35	03212	489881	389253
35	07767	489884	389253
38	68347	425571	432227
38	68349	378990	458674
38	73010	382816	458151
38	73017	379146	432227
38	77174	378993	432227
38	77420	378994	458174
38	77422	383500	458174
32	77722	378999	458174
32	77746	379000	458174
37	77770	379001	458674
37	77787	379188	458674
37	77794	379002	458151
37	77794	379002	458151
37	77796	386405	432227
37	77796	386405	458151
38	80009	379005	458147
38	80011	379007	432227
38	80012	379008	432227
33	80013	379009	458174
38	80016	379011	432227
33	80018	379012	458148
33	80019	379013	458154
33	80021	379015	432227
33	80022	379016	458148
33	80023	379017	458148
40	80142	394226	389252
37	80436	426104	458145
32	90004	458686	458152
32	90005	458840	458152
32	90006	458841	458674
32	90007	458843	458674
32	90008	458847	458674
32	90009	458850	458674
32	90010	458864	432227
36	90038	482542	389254
39	90044	489846	458178
33	90071	518392	458177
36	93010	480552	438174
36	93011	480553	458151
36	93012	480554	458148
36	93013	480555	458152
36	133450	387675	458145
37	165270	448203	458145
35	1150U	379026	432222
35	1152U	379027	458174
36	1153U	379028	389252
41	1155UR	379030	389252

Catalog Page #	Anchor Mfg. #	Catalog Item #	Rack Catalog Item #
36	1170U	379033	458177
36	1172U	379034	458177
41	121UR	379035	458149
41	139UR	379037	458145
41	143U	379038	389254
41	148U	379040	389254
41	16U	379043	458152
38	176FU	379045	432227
41	1830EU	379046	458150
35	18U	379047	458177
39	2047U	379050	458674
39	2051U	379051	458674
34	2081M	379052	432227
34	2085M	379053	432227
34	2095UX	379054	458177
39	2238U	379055	458152
36	2283Q	389980	458152
40	279U	379058	458178
33	2907M	427944	458674
33	2908M	379062	458148
33	2910M	379063	458148
34	2912UX	379064	458174
33	2915M	379065	458674
34	2917UX	379066	458177
32	2926M	379067	458148
32	2928M	379068	432227
32	2930M	379069	432227
33	2931M	379070	432227
33	2932M	379071	432227
32	2936M	379073	458148
32 & 33	2938M	427500	432227
33	2940M	427945	458148
33	2942M	379076	458148
40	308U	383413	432222
39	3108U	379082	458147
39	3113U	379086	458178
39	3141U	379089	458178
39	3143U	379090	458674
39	3167U	379093	458152
39	3168U	379094	458147
39	3169U	379095	458147
39	3170U	379096	458147
39	3172U	379097	458148
39	3175U	379098	432227
39	3178FU	379100	458674
39	3181EU	379101	458148
40	3532/6721U	379106	458148
40	3532U	379107	458148
36	3666EU	388133	389253
36	3667EU	386087	389253
36	3668U	379111	389253
33	3933M	379114	458674
33	3950M	446503	458674
33	3951M	379116	458178
39	5054U	386901	458674
34	524UX	379120	458149
36	5280/1612UL	389447	458142
36	5281/931U	379121	389253
36	5281/932U	379122	389253
36	5281U	379123	389253
36	5282/928U	379124	389253

TABLETOP

Rack extenders are available on a special order basis as needed.

Cambro Warewashing Racks Equivalency Chart

Catalog Page #	Anchor Mfg. #	Catalog Item #	Rack Catalog Item #
36	5282U	379126	389253
41	562U	379127	458174
41	563FU	379128	458174
41	56EU	379129	458674
41	575GU	379130	458152
41	6099U	379132	458152
40	69349T	385609	389252
40	69372T	382870	389252
40	69590R	400256	389252
38	7176FU	379135	432227
33	7221M	379141	458151
41	72U	379143	389254
37	7409U	379153	458148
37	7410U	379154	458148
37	7412U	379155	432227
40	7511U	395499	458152
40	7513U	379159	458152
40	7514U	379160	458147
32	7729U	379174	458151
32	7730U	379176	458151
32	7732U	379179	458151
32	7733U	379180	432227
32	7745U	379183	432222
37	77770R	379192	458674
37	77787R	379188	458674
37	77788R	379191	458674
37	77790R	379192	458178
37	77792R	379193	458151
32	799U	379195	458674
34	80226X	390644	458147
34	80278X	387645	458177
41	828U	379200	389254
41	842U	379201	389254
37	90054A	527923	458151
41	980R	425325	432227
37	H023202	396619	458145
34	H037491	396628	458174
38	H054504	414012	458674
38	H054539	414010	458674
38	H054540	417017	432227

Catalog Page #	Cardinal Mfg. #	Catalog Item #	Rack Catalog Item #
43	213	531456	N/A
51	556	531457	389252
51	1133	531459	389254
51	1141	531460	389254
51	1158	531461	389254
51	1166	531462	389254
51	1224	531463	389254
51	1273	531464	389252
43	4757	531465	432227
50	7131	531468	432227
50	7134	531470	458151
51	8781	531472	389254
43	9232	531475	N/A
51	9994	531476	389252
47	01005	531458	458152
47	05425	531467	458152
46	10007	531478	458674
51	10027	531480	389252

Catalog Page #	Cardinal Mfg. #	Catalog Item #	Rack Catalog Item #
47	12652	531699	458674
44	12926	531689	432227
44	14798	531701	458147
43	15442	531702	N/A
46	17197	531488	458178
46	17198	531502	458147
50	19343	531504	458151
47	20750	531506	458674
44	20864	531508	458151
44	20865	531509	458151
44	20866	531511	458151
44	20867	531512	458151
44	20868	531524	458147
44	20869	531526	458152
44	20871	531529	458152
43	20873	531530	458674
43	20874	531531	458674
43	20875	531532	458674
43	22760	531550	432222
43	23876	531552	432222
50	25263	531559	458147
50	25275	531563	458147
48	29811	531569	458674
47	29879	531570	458151
47	40326	531574	432227
47	40334	531575	458147
47	40383	531577	458674
47	43279	531704	458151
47	43280	531579	432222
47	43281	531581	432227
47	43282	531583	458174
49	43716	531589	458152
47	44032	531599	458674
46	46697	531705	458152
46	46774	531602	458147
44	46888	531604	458145
44	46961	531607	458147
44	46973	531609	432227
44	46978	531611	432227
45	46981	531707	458145
45	47017	531613	458174
45	47019	531615	458174
45	47026	531617	458145
44	47346	531619	458152
44	48024	531633	458147
47	48722	531642	458147
51	48728	531643	389254
49	49357	531645	458151
51	49698	531646	389252
44	50816	531649	432227
50	51254	531708	389254
42	51752	531650	458145
49	53224	531651	458674
46	53664	531652	458152
50	55878	531710	389254
46	57069	531654	458147
46	57070	531655	458147
46	57282	531469	458674
46	57286	531471	458147
45	58001	531479	N/A
45	62447	531711	N/A

Rack extenders are available on a special order basis as needed. N/A ask your customer service for specialized rack.

Cambro Warewashing Racks Equivalency Chart

Catalog Page #	Cardinal Mfg. #	Catalog Item #	Rack Catalog Item #
45	62449	531485	458145
50	62899	531489	389254
42	71075	531693	458174
43	71076	531490	432227
43	71078	531491	432222
43	71079	531492	432222
42	71080	531698	432227
43	71081	531493	458145
42	71082	531494	458151
42	71083	531495	432227
42	71084	531496	458147
42	71086	531497	432227
43	71092	531498	458147
43	71093	531499	458151
43	79320	531500	N/A
48	79698	531501	458151
48	79728	531503	458151
48	79747	531505	458674
42	101223	531657	458151
42	101226	531658	432227
48	101231	531669	458674
42	102086	531659	432227
50	165629	531680	458151
48	218416	531670	432222
42	332103	531660	458151
48	364624	531671	458674
42	366087	531661	432227
42	432100	531668	432227
50	442116	531682	458151
42	455078	531667	432227
48	481322	531672	458674
48	490249	531673	458674
50	521284	531679	432227
48	660962	531674	458151
48	664625	531675	432227
48	703225	531676	432222
42	887209	531665	458152
48	896402	531677	458174

Catalog Page #	Cardinal Mfg. #	Catalog Item #	Rack Catalog Item #
42	899289	531666	458151
49	1012316	531683	458151
49	1012317	531684	458151
49	1012318	531686	458151
49	1012319	531688	458151
50	C3966	531507	458152
45	D0795	531510	458145
44	D0796	531513	458147
43	D2024	531514	N/A
45	D6140	531515	N/A
51	D9016	531517	389252
51	D9070	531518	389252
49	E1515	531519	458178
49	E1516	531520	432222
48	E1907	531521	458178
45	E2788	531522	458145
45	E2789	531523	458145
45	E2790	531525	458145
44	E5358	531527	458147
46	E8516	531528	458145
46	E8518	531535	458145
46	E8519	531536	458147
46	E8520	531537	432227
49	E8792	531538	458151
51	E8883	531539	389252
51	E9155	531541	389252
51	E9156	531543	389252
51	E9157	531545	389252
51	E9158	531547	389252
51	E9159	531551	389252
51	E9160	531553	389252
45	E9336	531555	432222
51	G2100	531558	389252
51	G2102	531560	389252
45	G3570	531566	432227
45	G3573	531568	432227
51	G4315	531580	389254

Rack extenders are available on a special order basis as needed. N/A ask your customer service for specialized rack.

CAMWEAR® HUNTINGTON TUMBLERS™

- Polycarbonate – virtually unbreakable and resistant to wear and tear
- The elegant feel, look and luster of fine glass with lighter weight
- Stacking lugs ensure they won't stick together, even if they're damp when you put them away
- Drying is a breeze because of the special 3-sided drain bottom
- Color: Clear
- Dishwasher safe
- Cs Pk 1 x 3 dz



Item #	Mfg. #	Description	Cs Wt
380062	HT8CW-135	8 oz	5.26 lb
369918	HT10CW-135	10 oz	7.20 lb
369843	HT12CW-135	12 oz	6.95 lb
380061	HT16CW-135	16 oz	8.39 lb
370014	HT22CW-135	22 oz	10.55 lb

Sold in case pack only.

LAGUNA™ TUMBLERS

- Look as good as glass, but are made of break resistant SAN
- The hammered texture catches light and hides water spots or scratches
- Conveniently stack to save space
- Lightweight and easy to carry
- Dishwasher safe
- Cs Pk 1 x 3 dz



Item #	Mfg. #	Description	Cs Wt
388035	LT6-152	6 oz	4.28 lb
380072	LT8-152	8 oz	5.08 lb
388036	LT10-152	10 oz	5.94 lb
380064	LT12-152	12 oz	6.41 lb
380069	LT16-152	16 oz	7.99 lb
380071	LT22-152	22 oz	10.19 lb

Sold in case pack only.



COLORWARE TUMBLERS

- Stacking and storing are easy with interior stacking lugs
- Textured exterior resists scratching; smooth interior cleans easily
- Sani-Rim lip provides sanitary drinking surface
- Made of impact-resistant plastic that is dishwasher safe

Item #	Mfg. #	Description	Cs Pk	Cs Wt
375778	500P2-153	5.2 oz, Amber	1 x 2 dz	2.21 lb
368333	500P2-152	5.2 oz, Clear	1 x 2 dz	2.21 lb
398319	500P2-156	5.2 oz, Red	1 x 2 dz	2.21 lb
368213	500P-153	5.2 oz, Amber	1 x 6 dz	7.56 lb
367810	500P-152	5.2 oz, Clear	1 x 6 dz	7.56 lb
388024	500P-156	5.2 oz, Red	1 x 6 dz	7.56 lb
367961	800P-153	7.8 oz, Amber	1 x 6 dz	7.85 lb
368887	800P-152	7.8 oz, Clear	1 x 6 dz	7.85 lb
388025	800P-156	7.8 oz, Red	1 x 6 dz	7.85 lb
380598	800P2-153	7.8 oz, Amber	1 x 2 dz	2.74 lb
368299	800P2-152	7.8 oz, Clear	1 x 2 dz	2.74 lb
397305	800P2-156	7.8 oz, Red	1 x 2 dz	2.74 lb
388026	900P-153	9.7 oz, Short, Amber	1 x 6 dz	8.42 lb
398321	900P2-152	9.7 oz, Short, Clear	1 x 2 dz	2.90 lb
368218	950P-153	9.8 oz, Amber	1 x 6 dz	9.50 lb
367973	950P-152	9.8 oz, Clear	1 x 6 dz	9.50 lb
380605	950P2-153	9.8 oz, Amber	1 x 2 dz	3.29 lb
369882	950P2-152	9.8 oz, Clear	1 x 2 dz	3.29 lb
368124	1200P-153	12.6 oz, Amber	1 x 6 dz	11.75 lb
368130	1200P-152	12.6 oz, Clear	1 x 6 dz	11.75 lb
369889	1200P2-153	12.6 oz, Amber	1 x 2 dz	3.84 lb
368192	1200P2-152	12.6 oz, Clear	1 x 2 dz	3.84 lb
386395	1200P2-156	12.6 oz, Red	1 x 2 dz	3.84 lb
368013	1600P-153	16.4 oz, Amber	1 x 6 dz	14.76 lb
367940	1600P-152	16.4 oz, Clear	1 x 6 dz	14.76 lb
368328	1600P2-153	16.4 oz, Amber	1 x 2 dz	4.80 lb
380060	1600P2-152	16.4 oz, Clear	1 x 2 dz	4.80 lb
370016	1600P2-156	16.4 oz, Red	1 x 2 dz	4.80 lb
369886	2000P-153	22 oz, Amber	1 x 6 dz	16.99 lb
367950	2000P-152	22 oz, Clear	1 x 6 dz	16.99 lb
376213	2000P-156	22 oz, Red	1 x 6 dz	16.99 lb
369847	2000P2-153	22 oz, Amber	1 x 2 dz	5.81 lb
373978	2000P2-152	22 oz, Clear	1 x 2 dz	5.81 lb
384521	2000P2-156	22 oz, Red	1 x 2 dz	5.81 lb
368024	3200P2-153	32 oz, Amber	1 x 2 dz	7.90 lb
371389	3200P2-152	32 oz, Clear	1 x 2 dz	7.90 lb
390412	3200P2-156	32 oz, Red	1 x 2 dz	7.90 lb

Sold in case pack only.

BAHAMA TUMBLERS

- High quality, break-resistant SAN plastic
- Stackable and dishwasher safe
- Color: Clear
- Cs Pk 1 x 6 dz



Item #	Mfg. #	Description	Cs Wt
528871	9909-1-CL	9 oz	20.00 lb
528872	9912-1-CL	12 oz	23.00 lb
531259	9914-1-CL	14 oz	27.50 lb
528869	9916-1-CL	16 oz	30.00 lb
528870	9920-1-CL	20 oz	31.00 lb

Sold in case pack only.



NEWPORT TUMBLERS

- Made of impact resistant SAN plastic, they resist chips and breaks
- Fluted design adds a distinctive look to your tabletop
- Conveniently stacks out of your way
- Interior stacking lugs prevent sticking
- Dishwasher safe with a Sani-Rim lip to provide a sanitary drinking surface
- Color: Clear
- Cs Pk 1 x 3 dz



Item #	Mfg. #	Description	Cs Wt
485412	NT5-152	6.4 oz	3.60 lb
485415	NT8-152	7.7 oz	4.32 lb
485248	NT9-152	9.3 oz	4.43 lb
485389	NT10-152	10 oz	5.26 lb
485394	NT12-152	12.6 oz	5.62 lb
485409	NT20-152	22 oz	8.60 lb

Sold in case pack only.



TEXTURED TUMBLERS

- Stackable, scratch resistant and dishwasher safe
- Durable SAN reduces breakage
- Colors: Amber (A), Blue (BL), Red (R), or Clear (CL)



Item #	Mfg. #	Description	Cs Pk	Cs Wt
528072	6609-1-6-CL	9 oz, Clear	1 x 6 dz	11.00 lb
531403	6695-1-2-CL	9½ oz, Clear	1 x 2 dz	3.00 lb
528085	6695-1-6-CL	9½ oz, Clear	1 x 6 dz	11.00 lb
534408	6695-1-6-A	9½ oz, Amber	1 x 6 dz	11.00 lb
534410	6695-1-6-BL	9½ oz, Blue	1 x 6 dz	11.00 lb
528073	6612-1-2-CL	12 oz, Clear	1 x 2 dz	5.00 lb
531371	6612-1-2-R	12 oz, Red	1 x 2 dz	5.00 lb
531357	6612-1-2-A	12 oz, Amber	1 x 2 dz	5.00 lb
534411	6612-1-2-BL	12 oz, Blue	1 x 2 dz	5.00 lb
531378	6612-1-6-CL	12 oz, Clear	1 x 6 dz	15.00 lb
531379	6612-1-6-R	12 oz, Red	1 x 6 dz	15.00 lb
528074	6612-1-6-A	12 oz, Amber	1 x 6 dz	15.00 lb
531383	6616-1-2-CL	16 oz, Clear	1 x 2 dz	6.00 lb
531386	6616-1-2-R	16 oz, Red	1 x 2 dz	6.00 lb
531380	6616-1-2-A	16 oz, Amber	1 x 2 dz	6.00 lb
531382	6616-1-2-BL	16 oz, Blue	1 x 2 dz	6.00 lb
528076	6616-1-6-CL	16 oz, Clear	1 x 6 dz	18.00 lb
528075	6616-1-6-A	16 oz, Amber	1 x 6 dz	18.00 lb
531394	6620-1-2-CL	20 oz, Clear	1 x 2 dz	7.00 lb
531397	6620-1-2-R	20 oz, Red	1 x 2 dz	7.00 lb
531390	6620-1-2-BL	20 oz, Blue	1 x 2 dz	7.00 lb
528079	6620-1-6-CL	20 oz, Clear	1 x 6 dz	22.00 lb
528080	6620-1-6-R	20 oz, Red	1 x 6 dz	22.00 lb
528078	6620-1-6-A	20 oz, Amber	1 x 6 dz	22.00 lb
531400	6624-1-2-R	24 oz, Red	1 x 2 dz	8.00 lb
528081	6624-1-6-R	24 oz, Red	1 x 6 dz	24.00 lb
531402	6632-1-2-CL	32 oz, Tall, Clear	1 x 2 dz	9.00 lb
528083	6632-1-4-CL	32 oz, Tall, Clear	1 x 4 dz	19.00 lb
530444	6632-1-4-BL	32 oz, Tall, Blue	1 x 4 dz	19.00 lb

Sold in case pack only.



SPEKTRUM™ TUMBLERS

- Complements any dinner service
- Durable SAN material
- Color: Clear
- Stackable
- Cs Pk 1 x 6 dz



Item #	Mfg. #	Description	Cs Wt
531317	8812-1-CL	12 oz	14.00 lb
528086	8816-1-CL	16 oz	18.00 lb
531320	8820-1-CL	20 oz	19.00 lb

Sold in case pack only.

ROC N' ROLL™ TUMBLERS

- Sturdy base with bold design
- Look and feel like glass
- Dishwasher safe
- Shatter-proof
- Crafted from durable SAN
- Cs Pk 1 x 2 dz



#SW-1423-1-CL

#SW-1426-1-CL



Item #	Mfg. #	Description	Cs Wt
528874	SW-1423-1-CL	Rock, 9 oz	10.00 lb
531347	SW-1426-1-CL	Beverage, 14 oz	10.00 lb

Sold in case pack only.

BEER MUG

- Made of SAN plastic
- Dishwasher safe
- Color: Clear
- 12 oz



Item #528071
Mfg. #00084-1-CL
Cs Pk 1 x 2 dz
Cs Wt 12.00 lb
Sold in case pack only.



#SW-1427-1-CL

#SW-1409-1-CL

#SW-1431-1-CL

#SW-1408-1-CL

SHOTS & SHOOTERS



- Dishwasher safe, shatter-proof and very durable

Item #	Mfg. #	Description	Cs Pk	Cs Wt
531309	SW-1427-1-CL	Shot, 1 oz	1 x 2 dz	3.00 lb
531343	SW-1409-1-CL	Shot, Lined, 1½ oz	1 x 2 dz	3.00 lb
531315	SW-1431-1-CL	Shooter, 1 oz	1 x 4 dz	5.00 lb
531340	SW-1408-1-CL	Shooter, 3 oz	1 x 2 dz	3.00 lb

Sold in case pack only.

SUPER MARTINI

- High quality, durable SAN plastic
- Dishwasher safe
- 48 oz
- Color: Clear



Item #531345
Mfg. #SW-1419-1-CL
Cs Pk 1 x 3 ea
Cs Wt 6.00 lb
Sold in case pack only.



TOM COLLINS

- Durable break-resistant plastic
- 14 oz
- Color: Clear



Item #531324
Mfg. #H-14-1-CL
Cs Pk 1 x 2 dz
Cs Wt 7.00 lb
Sold in case pack only.



#SW-1406-1-CL

#SW-1402-1-CL

#SW-1404-1-CL

#SW-1401-1-CL

STEMWARE

- Durable break-resistant plastic barware
- Look and feel like glass
- Color: Clear
- Cs Pk 1 x 2 dz



Item #	Mfg. #	Description	Cs Wt
531339	SW-1406-1-CL	Wine, 6 oz	8.00 lb
531337	SW-1404-1-CL	Wine, 8 oz	8.00 lb
533140	SW-1402-1-CL	Martini, 6 oz	6.00 lb
529935	SW-1401-1-CL	Champagne, 6 oz	7.00 lb

Sold in case pack only.



#S-15-1-CL



#S-16-1-CL

SHAKERS

- Durable break-resistant plastic
- Color: Clear
- Cs Pk 1 x 2 dz



Item #	Mfg. #	Description	Cs Wt
531326	S-15-1-CL	14 oz	7.00 lb
531334	S-16-1-CL	Shamrock Imprint, 16 oz	7.00 lb

Sold in case pack only.



GLASS KEEPER

- Organizes your glass storage area
- Economical regal plastic
- Dishwasher safe – raised ribs for easy draining and drying
- 14" x 18"
- Color: Beige

Item #380059
 Mfg. #GK2000-133
 Cs Pk 12 x 1 ea
 Cs Wt 14.96 lb

Sold in case pack or eaches.

CAMWEAR® CAMLITER® BEVERAGE DECANTERS

- Made of polycarbonate – won't chip or break
- White spill-proof lid is included
- Allows you to fill and store beverages in off hours
- * Color: Clear
- Cs Pk 1 x 12 ea

Item #	Mfg. #	Description	Cs Wt
368030	WW1000CW-135	1 liter	7.00 lb
367969	WW500CW-135	½ liter	4.18 lb
369883	WW250CW-135	¼ liter	2.14 lb

Sold in case pack only.



CAMWEAR® PITCHERS

- Made of polycarbonate - won't chip or break
- Dishwasher safe
- Slotted base helps drain water for complete and sanitary drying



Item #	Mfg. #	Description	Cs Pk	Cs Wt
A.		Contemporary ribbed styling with broad base and ice lip		
369872	P60CW-135	60 oz, Clear	1 x 6 ea	6.43 lb
B.		Tapered shape, ribbed, drip-proof spout		
367756	P64CW-135	64 oz, Clear	1 x 6 ea	6.56 lb
C.		Covered pitcher, smooth sides		
368147	PC64CW-135	64 oz, Clear	1 x 6 ea	7.38 lb
Above pitchers sold in case pack only.				
D.		Ribbed styling with broad base and ice lip		
380084	P320CW-135	32 oz, Clear	6 x 1 ea	3.67 lb
380081	P480CW-135	48 oz, Clear	6 x 1 ea	4.78 lb
380086	P600CW-135	60 oz, Clear	6 x 1 ea	5.48 lb
380089	P600CW-153	60 oz, Amber	6 x 1 ea	5.48 lb

Sold in case pack or eaches.





PITCHER

- Plastic
- Granite with black 3-way sanitary lid
- 2½ qt

Item #431961

Mfg. #144GRT

Cs Pk 1 x 1 dz

Cs Wt 10.00 lb

Sold in case pack only.



TUFFEX® I THREE-LIP DELUXE PITCHER

- Virtually unbreakable polycarbonate
- Thumb grip pour control
- Dishwasher safe
- Ice catcher pour lip
- Wide base for stability
- Slotted base helps drain water, reduces water spotting, and speeds the drying process
- 60 oz • Color: Clear

Item #428563

Mfg #6010-13

Cs Pk 1 x 1 dz

Cs Wt 13.00 lb

Sold in case pack only.



CAMWEAR® LAGUNA® PITCHER

- Made of polycarbonate – won't chip or break
- Hammered texture catches the light and hides scratches
- Contoured lip design allows for easy pouring with ice from front or sides
- 60 oz
- Color: Clear

Item #387809

Mfg. #PL60CW-135

Cs Pk 1 x 6 ea

Cs Wt 4.42 lb

Sold in case pack only.



CAMWEAR® ECONOMY PITCHER

- Made of polycarbonate – won't chip or break
- Dishwasher safe
- Slotted base helps drain water for complete and sanitary drying
- 60 oz • Color: Clear

Item #527646

Mfg. #PE600CW-135

Cs Pk 6 x 1 ea

Cs Wt 4.42 lb

Sold in case pack or eaches.



#WPC-60



#WPCT-60C

WATER PITCHERS

- Clear polycarbonate
- Cs Pk 12 x 1 ea

Item #

Mfg. #

Description

Cs Wt

504956

WPC-60

60 oz

9.00 lb

504958

WPCT-60C

60 oz, Three Spout

9.96 lb

Sold in case pack or eaches.



PITCHER W/LID

- Durable and economical SAN water pitcher
- Tapered lip for controlled pouring of beverage with ice
- Dishwasher safe
- 64 oz • Color: Clear

Item #528113

Mfg. #P-3064-1-CL

Cs Pk 1 x 1 dz

Cs Wt 15.00 lb

Sold in case pack only.



WATER PITCHER

- Made of heavy-duty SAN material
- Break resistant and dishwasher safe
- Ideal for beer, water, juice, soda and more
- 32 oz • Color: Clear

Item #482443

Mfg. #WP-32SC

Cs Pk 12 x 1 ea

Cs Wt 6.60 lb

Sold in case pack or eaches.



CARAFE/DECANTER w/LID

- Polycarbonate, chip and break resistant
- Spill proof lid included
- Dishwasher safe
- 1 liter (33.8 oz) • Color: Clear

Item #529456

Mfg. #BW-1100-CL

Cs Pk 1 x 1 dz

Cs Wt 8.00 lb

Sold in case pack only.



PITCHER

- Clear polycarbonate
- 3 spout design for easy pouring
- Perfect for at-table use
- 60 oz

Item #482444

Mfg. #WP-60PC

Cs Pk 12 x 1 ea

Cs Wt 12.10 lb

Sold in case pack or eaches.

UNDECORATED ROLLED EDGE

- Twice fired, cream white body with reinforced rolled edge
- Makes smaller portions appear larger • Limited 3 year no-chip warranty

Item #	Mfg. #	Description	Cs Pk	Cs Wt
386911	F150 0000 111	Plate, 5½"	1 x 3 dz	18.50 lb
389129	F250 0000 117	Plate, 6¼"	1 x 3 dz	22.30 lb
389627	F250 0000 124	Plate, 7⅛"	1 x 3 dz	31.50 lb
369639	F150 0000 139	Plate, 9"	1 x 2 dz	35.60 lb
371427	F150 0000 145	Plate, 9¾"	1 x 2 dz	39.60 lb
372937	F150 0000 151	Plate, 10½"	1 x 1 dz	28.40 lb
394631	F150 0000 156	Plate, 11⅛"	1 x 1 dz	31.30 lb
370711	F150 0000 342	Platter, 9¾" x 6¾"	1 x 2 dz	29.50 lb
369604	F150 0000 359	Platter, 11½" x 7⅞"	1 x 1 dz	20.70 lb
369501	F150 0000 700	Bouillon, Atlantic, 4", 7¼ oz	1 x 3 dz	21.00 lb
369647	F150 0000 710	Fruit, 4¼", 3¾ oz	1 x 3 dz	16.90 lb
378410	F250 0000 711	Fruit, 4¾", 5 oz	1 x 3 dz	16.10 lb
372545	F150 0000 720	Grapefruit, 6¾", 13 oz	1 x 3 dz	30.10 lb
370730	F150 0000 731	Nappy, 5¾", 12½ oz	1 x 3 dz	35.10 lb
420453	F150 0000 740	Soup, Rim, 8", 15 oz	1 x 2 dz	27.70 lb
370719	F150 0000 741	Soup, Rim, 9", 24 oz	1 x 2 dz	40.00 lb
372924	F150 0000 520	Cup, Mohawk, 3 ²⁵ / ₃₂ ", 8 oz	1 x 3 dz	22.00 lb
370713	F150 0000 501	Saucer, Pacific, 5½"	1 x 3 dz	18.70 lb
378451	F150 0000 525	Cup, A.D., 2½", 3½ oz	1 x 3 dz	12.00 lb
378450	F150 0000 505	Saucer, A.D., 4⅞"	1 x 3 dz	14.10 lb
370738	F150 0000 560	Mug, Park, 3", 8 oz	1 x 3 dz	32.00 lb
369617	F199 2000 560	Mug, Northland, 3¾", 7½ oz	1 x 2 dz	40.00 lb

Sold in case pack only.

Buffalo Collection – Ivory White Rolled Edge



UNDECORATED ESPREE

- Fine gauge and lightweight • Modest rim width provides generous serving space
- Twice fired, cream white body with a reinforced edge • Limited 3 year no-chip warranty

Item #	Mfg. #	Description	Cs Pk	Cs Wt
369021	F104 0000 117	Plate, 6¼"	1 x 3 dz	20.60 lb
369642	F104 0000 125	Plate, 7¼"	1 x 3 dz	29.20 lb
369027	F104 0000 139	Plate, 9"	1 x 2 dz	29.60 lb
390053	F104 0000 145	Plate, 9¾"	1 x 2 dz	34.60 lb
369035	F104 0000 149	Plate, 10¼"	1 x 1 dz	18.40 lb
369627	F104 0000 163	Plate, 12"	1 x 1 dz	28.50 lb
370734	F104 0000 361	Platter, 11¾" x 8½"	1 x 1 dz	20.70 lb
369030	F104 0000 700	Bouillon, Classic, 3⅝", 7½ oz	1 x 3 dz	21.00 lb
369629	F104 0000 710	Fruit, 5¼", 5¾ oz	1 x 3 dz	16.90 lb
369484	F104 0000 720	Grapefruit, 6¾", 11½ oz	1 x 3 dz	26.40 lb
369477	F104 0000 740	Soup, Rim, 8½", 17½ oz	1 x 2 dz	31.00 lb
372837	F104 0000 760	Bowl, 5", 12 oz	1 x 3 dz	22.20 lb
371432	F104 0000 510	Cup, Talisman, 3⅝", 7 oz	1 x 3 dz	19.40 lb
369459	F104 0000 520	Cup, Lotus, 3⅝", 7½ oz	1 x 3 dz	19.00 lb
372525	F104 0000 560	Mug, 3⅛", 8 oz	1 x 3 dz	36.00 lb
369466	F104 0000 500	Saucer, 5½"	1 x 3 dz	16.90 lb

Sold in case pack only.

ONEIDA®



ACCENT BURGUNDY ESPREE SHAPE

- Tasteful burgundy line underscores a sculptured rim of smooth curving lines which culminate in dramatic sprays • This fine gauge, light weight shape is as compatible as it is elegant and blends beautifully with most any décor • Twice fired, cream white body with a reinforced edge • Limited 3-year no-chip warranty

Item #	Mfg. #	Description	Cs Pk	Cs Wt
408989	F1040728117	Plate, 6¼"	1 x 3 dz	20.60 lb
399709	F1040728139	Plate, 9"	1 x 2 dz	29.60 lb
398231	F1040728700	Bouillon, 3⅝", 7½ oz	1 x 3 dz	18.60 lb
386815	F1040728710	Fruit, 5¼", 5¾ oz	1 x 3 dz	16.90 lb
460516*	F1040728510	Cup, Talisman, 7 oz	1 x 3 dz	19.40 lb
397115*	F1040728500	Saucer, 5½"	1 x 3 dz	16.90 lb

Sold in case pack only. * Special Order



Plate



Bouillon



Fruit



Saucer



Cup



ONEIDA®



DELCO ONEIDA®

UNDECORATED ARCADIA

- Bright white porcelain body with a reinforced edge
- Extremely durable and practical with a mid-rim shape and graceful embossed surface
- Limited 1 year no-chip warranty

Item #	Mfg. #	Description	Cs Pk	Cs Wt
388612	R451 0000 119	Plate, 6½"	1 x 3 dz	22.00 lb
388613	R451 0000 127	Plate, 7½"	1 x 3 dz	27.70 lb
389664	R451 0000 139	Plate, 9"	1 x 2 dz	28.00 lb
394974	R451 0000 146	Plate, 9⅝"	1 x 2 dz	33.00 lb
391042	R451 0000 152	Plate, 10⅝"	1 x 1 dz	21.00 lb
388614	R451 0000 163	Plate, 12"	1 x 1 dz	24.80 lb
391040	R451 0000 700	Bouillon, 7½ oz	1 x 3 dz	21.00 lb
391039	R451 0000 706	Bouillon, Lugs, 5¼", 10 oz	1 x 3 dz	23.50 lb
388611	R451 0000 712	Fruit, 5⅝"	1 x 3 dz	14.00 lb
394905	R451 0000 720	Grapefruit, 6½", 10 oz	1 x 3 dz	27.00 lb
401814	R451 0000 740	Soup, Rim, 9", 12 oz	1 x 2 dz	30.00 lb
389341	R451 0000 521	Tall Cup, 4⅞", 7 oz	1 x 3 dz	19.30 lb
409451	R451 0000 520	Low Cup, 4⅞", 8 oz	1 x 3 dz	23.00 lb
391038	R451 0000 567	Mug, Stackable, 4¾", 10 oz	1 x 3 dz	25.00 lb
389342	R451 0000 501	Saucer, 5⅝"	1 x 3 dz	16.00 lb

Sold in case pack only.



Plate



Bouillon



Fruit



Grapefruit



Rim Soup



Mug



Tall Cup



Low Cup



Saucer

PORCELAIN UNDECORATED

- Square plates make the perfect blank canvas for your culinary creations
- Bright, white porcelain body • Hard, scratch-resistant glaze
- Finely polished foot

Item #	Mfg. #	Description	Cs Pk	Cs Wt
482941	F500 0000 117S	Plate, Square, 6¼"	1 x 3 dz	30.60 lb
480167	F500 0000 149S	Plate, Square, 10¼"	1 x 1 dz	35.30 lb

Sold in case pack only.



Plate, Square

ONEIDA®



UNDECORATED CAPRICE™

- Twice fired, cream white body with a distinctive, reinforced scalloped rim
- Durable enough to meet the demands of heavy-duty use
- Limited 5 year no-chip warranty

Item #	Mfg. #	Description	Cs Pk	Cs Wt
370752*	F156 0000 126	Plate, 7 $\frac{3}{8}$ "	1 x 3 dz	34.00 lb
370751*	F156 0000 144	Plate, 9 $\frac{3}{8}$ "	1 x 2 dz	43.40 lb
369033	F156 0000 346	Platter, 9 $\frac{7}{8}$ " x 7 $\frac{3}{8}$ "	1 x 2 dz	35.40 lb
369023	F156 0000 360	Platter, 11 $\frac{1}{8}$ " x 8 $\frac{7}{8}$ "	1 x 1 dz	24.30 lb
369609	F156 0000 710	Fruit, 4 $\frac{3}{4}$ ", 4 $\frac{1}{2}$ oz	1 x 3 dz	14.40 lb
378411	F156 0000 520	Cup, 4 $\frac{1}{16}$ ", 7 $\frac{1}{4}$ oz	1 x 3 dz	25.10 lb
370731	F156 0000 500	Saucer, 5 $\frac{5}{8}$ "	1 x 3 dz	21.00 lb

Sold in case pack only. * Special Order



Plate



Platter



Fruit



Cup



Saucer

BUFFALO
CHINA IMPORTED BY ONEIDA, BUFFALO, NEW YORK, U.S.A.

UNDECORATED CONSERVO™

- Twice fired, cream white body with a reinforced narrow rim and large well
- Suitable for cafeterias, diners, schools, healthcare and more
- Limited 5 year no-chip warranty

Item #	Mfg. #	Description	Cs Pk	Cs Wt
370741	F252 0000 111	Plate, 5 $\frac{1}{2}$ "	1 x 3 dz	16.30 lb
388091	F252 0000 119	Plate, 6 $\frac{1}{2}$ "	1 x 3 dz	22.00 lb
369521	F252 0000 125	Plate, 7 $\frac{1}{4}$ "	1 x 3 dz	30.00 lb
369616	F152 0000 139	Plate, 9"	1 x 2 dz	38.60 lb
370721	F152 0000 151	Plate, 10 $\frac{1}{2}$ "	1 x 1 dz	26.00 lb
369633	F152 0000 359	Platter, 11 $\frac{1}{2}$ " x 9 $\frac{1}{4}$ "	1 x 1 dz	25.90 lb
369612	F152 0000 510	Cup, Jose, 3 $\frac{3}{8}$ ", 7 oz	1 x 3 dz	29.00 lb
426530	F152 0000 560	Mug, Colony, 2 $\frac{5}{16}$ ", 8 oz	1 x 3 dz	30.70 lb

Sold in case pack only.



Plate



Platter



Jose Cup



Colony Mug

BUFFALO
CHINA IMPORTED BY ONEIDA, BUFFALO, NEW YORK, U.S.A.



CLASSIC UNDECORATED

- Twice fired, cream white body with reinforced cord edge
- The wide-rim design of classic is ideal for showing off smaller portions
- Suitable for hotels and country clubs
- Limited 3 year no-chip warranty

ONEIDA®

Item #	Mfg. #	Description	Cs Pk	Cs Wt
382919*	F100 0000 116	Plate, 6 $\frac{1}{8}$ "	1 x 3 dz	19.40 lb
405683	F100 0000 134	Plate, 8 $\frac{3}{8}$ "	1 x 2 dz	23.50 lb
405693	F100 0000 700	Bouillon, 3 $\frac{7}{8}$ ", 7 oz	1 x 3 dz	19.90 lb
372921	F100 0000 705	Bouillon, Dallas, 3 $\frac{7}{8}$ ", 8 oz	1 x 3 dz	22.10 lb
372927	F100 0000 765	Bowl, Dallas, 4 $\frac{5}{8}$ ", 12 $\frac{1}{2}$ oz	1 x 3 dz	26.30 lb
405694*	F100 0000 740	Soup, Rim, 9 $\frac{1}{4}$ ", 28 oz	1 x 2 dz	36.20 lb
386795	F100 0000 790	Pasta/Salad Bowl, 11 $\frac{5}{8}$ ", 35 oz	1 x 1 dz	25.10 lb
394620	F100 0000 500	Saucer, 5 $\frac{5}{8}$ "	1 x 3 dz	19.70 lb
405689	F100 0000 528	Cup, Sussex, 3 $\frac{1}{2}$ ", 8 $\frac{1}{2}$ oz	1 x 3 dz	21.40 lb

Sold in case pack only. * Special order



Plate



Bouillon



Dallas Bouillon



Dallas Bowl



Rim Soup



Pasta/Salad Bowl



Sussex Cup



Saucer

ONEIDA®

SOL CHINA

- Bright white porcelain body • Hard, scratch-resistant glaze
- Finely polished foot • Banquet style, mid rim plate design
- Reinforced edges • 1 year limited no chip warranty



Item #	Mfg. #	Description	Cs Pk	Cs Wt
495129*	F501 0000 119	Plate, 6½" dia	1 x 3 dz	22.80 lb
495130*	F501 0000 131	Plate, 8¼" dia	1 x 2 dz	25.20 lb
495131*	F501 0000 143	Plate, 9½" dia	1 x 1 dz	14.00 lb
495132*	F501 0000 149	Plate, 10¼" dia	1 x 1 dz	18.90 lb
495133*	F501 0000 163	Plate, 12" dia	1 x 6 ea	14.30 lb
495135*	F501 0000 358	Platter, 11" x 8"	1 x 1 dz	18.50 lb
495136*	F501 0000 368	Platter, 12⅝" x 9⅝"	1 x 6 ea	13.80 lb
495134*	F501 0000 705	Bouillon, Stackable, 7 oz	1 x 2 dz	13.30 lb
495128*	F501 0000 740	Soup, Rim, 9" dia	1 x 1 dz	14.60 lb
495120*	F501 0000 760	Bowl, Salad, Stackable, 6"	1 x 2 dz	23.00 lb
495121*	F501 0000 765	Bowl, Serving, Stackable, 9⅝"	1 x 1 dz	17.30 lb
495127*	F501 0000 758	Bowl, Small Well, 10⅝"	1 x 1 dz	20.60 lb
495123*	F501 0000 535	Cup, AD, Stackable, 3 oz	1 x 3 dz	11.80 lb
495124*	F501 0000 505	Saucer, AD, 4⅝"	1 x 3 dz	10.60 lb
495125*	F501 0000 530	Cup, Stackable, 9½ oz	1 x 3 dz	22.60 lb
495126*	F501 0000 500	Saucer, 6¼"	1 x 3 dz	21.40 lb

Sold in case pack only. * Special order

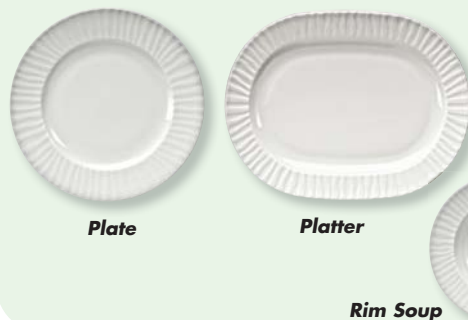

QUARTET CHINA

- Bright white porcelain body • Hard, scratch-resistant glaze
- Finely polished foot • Reinforced corded edges

Item #	Mfg. #	Description	Cs Pk	Cs Wt
495102*	F502 0000 120	Plate, Square, 6¾"	1 x 3 dz	23.70 lb
495103*	F502 0000 127	Plate, Square, 7½"	1 x 2 dz	19.00 lb
495104*	F502 0000 131	Plate, Square, 8¼"	1 x 2 dz	25.20 lb
495105*	F502 0000 148	Plate, Square, 10⅝"	1 x 1 dz	23.80 lb
495106*	F502 0000 155	Plate, Square, 11"	1 x 6 ea	14.50 lb
495107*	F502 0000 167	Plate, Square, 12½"	1 x 6 ea	20.50 lb
495109*	F502 0000 343	Platter, Rectangular, Deep, 9⅝" x 6⅝"	1 x 1 dz	13.10 lb
495110*	F502 0000 358	Platter, Rectangular, 11" x 7¾"	1 x 1 dz	15.10 lb
495111*	F502 0000 368	Platter, Rectangular, 12½" x 8⅝"	1 x 6 ea	23.30 lb
495112*	F502 0000 391	Platter, Rectangular, 15" x 10⅝"	1 x 6 ea	19.70 lb
495093*	F502 0000 705	Bouillon, Handled, Square, 11 oz	1 x 3 dz	20.30 lb
495095*	F502 0000 506	Bouillon, Saucer, Square, 6"	1 x 3 dz	22.30 lb
495101*	F502 0000 740	Soup, Rim, Square, 9"	1 x 1 dz	16.10 lb
495114*	F502 0000 736	Bowl, Salad, Square, 7⅝"	1 x 2 dz	23.40 lb
495113*	F502 0000 715	Bowl, Dip, Square, 5⅝"	1 x 3 dz	18.10 lb
495115*	F502 0000 738	Bowl, Serving, Square, 8⅝"	1 x 6 ea	13.20 lb
495116*	F502 0000 758	Bowl, Dessert, Small Well, Square, 10¼"	1 x 1 dz	26.60 lb
495096*	F502 0000 510	Cup, Tall, Square, 8 oz	1 x 3 dz	15.30 lb
495098*	F502 0000 524	Cup, Cappuccino, Square, 12 oz	1 x 3 dz	16.90 lb
495097*	F502 0000 500	Saucer, Square, 5⅝"	1 x 3 dz	17.70 lb
495100*	F502 0000 504	Saucer, Cappuccino, Square, 6⅝"	1 x 3 dz	22.30 lb
495108*	F502 0000 563	Mug, Square, 12 oz	1 x 3 dz	23.30 lb
495117*	F502 0000 910	Salt Shaker, Square, 1⅝"	1 x 4 dz	8.60 lb
495118*	F502 0000 911	Pepper Shaker, Square, 1⅝"	1 x 4 dz	8.60 lb
495119*	F502 0000 900	Sugar Bowl w/Cover, Square, 3¾"	1 x 2 dz	19.90 lb

Sold in case pack only. * Special order

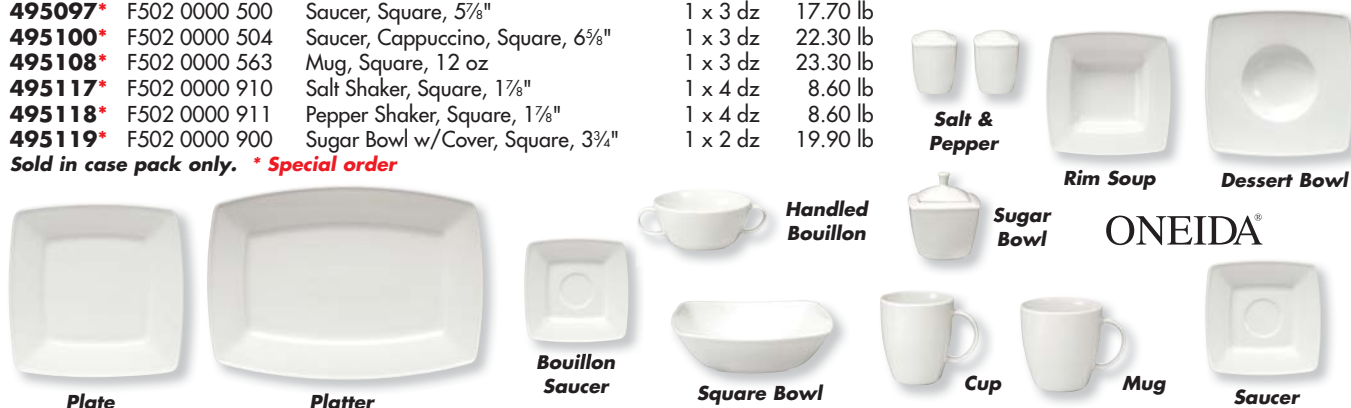

ONEIDA®

ATLANTIC™ CHINA

- Practical - two classic shapes, narrow rim and rolled edge
- Affordable, with years of service and low replacement cost
- Cream white body with a reinforced rim
- Two distinct patterns provide the perfect frame for any course

Narrow Rim Shape

Item #	Mfg. #	Description	Cs Pk	Cs Wt
388663	R454 0000 711	Fruit, 4 ³ / ₈ "	1 x 3 dz	17.10 lb
388642	R454 0000 111	Plate, 5 ¹ / ₂ "	1 x 3 dz	16.10 lb
388652	R454 0000 119	Plate, 6 ¹ / ₂ "	1 x 3 dz	24.10 lb
388653	R454 0000 127	Plate, 7 ¹ / ₂ "	1 x 3 dz	32.40 lb
388655	R454 0000 139	Plate, 9"	1 x 2 dz	37.00 lb
388656	R454 0000 143	Plate, 9 ¹ / ₂ "	1 x 2 dz	42.30 lb
388657	R454 0000 151	Plate, 10 ¹ / ₄ "	1 x 1 dz	25.90 lb
388659	R454 0000 343	Platter, Oval, 9 ¹ / ₂ "	1 x 2 dz	42.50 lb
388661	R454 0000 359	Platter, Oval, 11 ¹ / ₂ "	1 x 1 dz	29.50 lb
388662	R454 0000 373	Platter, Oval, 13 ¹ / ₄ "	1 x 1 dz	39.80 lb

Rolled Edge Shape

388633	R453 0000 710	Fruit, 4"	1 x 3 dz	10.60 lb
388634	R453 0000 711	Fruit, 4 ³ / ₄ "	1 x 3 dz	17.10 lb
388624	R453 0000 111	Plate, 5 ¹ / ₂ "	1 x 3 dz	17.90 lb
388625	R453 0000 117	Plate, 6 ¹ / ₄ "	1 x 3 dz	22.10 lb
388626	R453 0000 124	Plate, 7 ¹ / ₈ "	1 x 3 dz	32.90 lb
388627	R453 0000 139	Plate, 9"	1 x 2 dz	35.80 lb
388628	R453 0000 144	Plate, 9 ³ / ₈ "	1 x 2 dz	47.00 lb
439054	R453 0000 149	Plate, 10 ¹ / ₂ "	1 x 1 dz	23.00 lb
398927	R453 0000 163	Plate, 12"	1 x 1 dz	35.00 lb
388630	R453 0000 342	Platter, Oval, 9 ³ / ₈ "	1 x 2 dz	33.70 lb
388631	R453 0000 360	Platter, Oval, 11 ³ / ₈ "	1 x 1 dz	24.70 lb
391493	R453 0000 368	Platter, Oval, 12 ³ / ₈ "	1 x 1 dz	29.30 lb

Accessories for Narrow Rim and Rolled Edge Shapes

388594	R453 0000 521	Cup, Tall, 4 ¹ / ₂ ", 7 oz	1 x 3 dz	25.00 lb
388592	R453 0000 501	Saucer, Tea, 5 ¹ / ₂ "	1 x 3 dz	21.40 lb
388599	R453 0000 560	Mug, Delmonico, 8 oz	1 x 3 dz	28.30 lb
389097	R417 0000 560	Mug, Sierra, 8 oz	1 x 3 dz	29.00 lb
388635	R453 0000 720	Grapefruit, 6 ³ / ₈ ", 10 oz	1 x 3 dz	31.80 lb
388639	R453 0000 740	Soup, Rim, 9", 24 ¹ / ₄ oz	1 x 2 dz	38.30 lb
388636	R453 0000 731	Nappy, 12 oz	1 x 3 dz	30.00 lb
388638	R453 0000 733	Nappy, 15 oz	1 x 3 dz	37.10 lb
388632	R453 0000 700	Bouillon, 7 ¹ / ₂ oz	1 x 3 dz	21.70 lb
388602	R453 0000 756	Bowl, Pasta Coupe 7 ³ / ₈ ", 32 oz	1 x 2 dz	41.00 lb
388604	R453 0000 790	Bowl, Pasta, 11 ³ / ₈ ", 30 oz	1 x 1 dz	34.70 lb

Sold in case pack only.



DELCO

ONEIDA®



CERAMICOR™ CHINA

Bright White

- Clean lines and ultra-white body
- Ceramicor Porcelain is extremely durable and practical
- Choose from Narrow Rim or Rolled Edge patterns

Bright White Narrow Rim



Bright White Rolled Edge



Narrow Rim Shape

Item #	Mfg. #	Description	Cs Pk	Cs Wt
388816	R447 0000 111	Plate, 5½"	1 x 3 dz	18.90 lb
388810	R447 0000 119	Plate, 6½"	1 x 3 dz	23.40 lb
388814	R447 0000 125	Plate, 7¼"	1 x 3 dz	29.20 lb
430159	R447 0000 133	Plate, 8¼"	1 x 2 dz	27.40 lb
388818	R447 0000 139	Plate, 9"	1 x 2 dz	32.90 lb
388808	R447 0000 143	Plate, 9½"	1 x 2 dz	39.30 lb
398975	R447 0000 147	Plate, 10"	1 x 2 dz	43.70 lb
388824	R447 0000 151	Plate, 10½"	1 x 1 dz	25.00 lb
388811	R447 0000 347	Platter, Oval, 10"	1 x 1 dz	16.00 lb
388809	R447 0000 359	Platter, Oval, 11½"	1 x 1 dz	22.50 lb
388825	R447 0000 371	Platter, Oval, 13"	1 x 1 dz	29.80 lb
388812	R447 0000 711	Fruit, 4¾"	1 x 3 dz	15.00 lb

Rolled Edge Shape

388826	R448 0000 111	Plate, 5½"	1 x 3 dz	14.80 lb
388616	R448 0000 117	Plate, 6¼"	1 x 3 dz	19.00 lb
388617	R448 0000 127	Plate, 7½"	1 x 3 dz	27.80 lb
388827	R448 0000 139	Plate, 9"	1 x 2 dz	31.30 lb
388828	R448 0000 143	Plate, 9½"	1 x 2 dz	37.30 lb
388618	R448 0000 151	Plate, 10½"	1 x 1 dz	22.90 lb
388619	R448 0000 163	Plate, 12"	1 x 1 dz	31.40 lb
388829	R448 0000 347	Platter, Oval, 10"	1 x 1 dz	15.00 lb
388830	R448 0000 361	Platter, Oval, 11¾"	1 x 1 dz	21.70 lb
393081	R448 0000 371	Platter, Oval, 13"	1 x 1 dz	26.00 lb
392058	R448 0000 387	Platter, Oval, 15"	1 x 6 ea	17.20 lb
389141	R448 0000 711	Fruit, 4¾"	1 x 3 dz	15.00 lb

Accessories for Narrow Rim and Rolled Edge Shapes

388622	R448 0000 720	Grapefruit, 6¼", 8 oz	1 x 3 dz	23.00 lb
388623	R448 0000 740	Soup, Rim, 9", 12 oz	1 x 2 dz	28.90 lb
388832	R448 0000 731	Nappy, 5¼", 12 oz	1 x 3 dz	24.90 lb
388807	R448 0000 733	Nappy, 5¾", 15 oz	1 x 3 dz	35.40 lb
388806	R448 0000 700	Bouillon, 7½ oz	1 x 3 dz	18.60 lb
388601	R448 0000 790	Pasta Bowl, 12", 22 oz	1 x 1 dz	33.80 lb
389098	R452 0000 600	Souffle, 3¾", 6 oz	1 x 1 dz	9.50 lb
388598	R452 0000 603	Souffle, 4¾", 10 oz	1 x 1 dz	8.50 lb
388833	R448 0000 525	A.D. Cup (Stackable) 3½ oz	1 x 3 dz	11.70 lb
388834	R448 0000 505	A.D. Saucer, 4¼"	1 x 3 dz	9.80 lb
423207	R448 0000 508	A.D. Saucer, Milano, 4¼"	1 x 3 dz	11.30 lb
388591	R448 0000 510	Cup Tall, 7½ oz	1 x 3 dz	20.00 lb
388586	R448 0000 501	Saucer, Standard, 5¾"	1 x 3 dz	18.00 lb
423227	R448 0000 502	Saucer, Tea (Stackable) 5¾"	1 x 3 dz	19.10 lb
423221	R448 0000 530	Cup (Stackable) 4¾", 6½ oz	1 x 3 dz	19.70 lb
423206	R448 0000 535	A.D. Sip Milano (Stackable) 3 oz	1 x 3 dz	12.30 lb
388835	R448 0000 560	Mug, Concord, 8¾ oz	1 x 3 dz	26.30 lb

ClearPac™ Ceramicor - Packaged For Cash & Carry

430190	R447 0000 119C	Plate, Narrow Rim, 6½"	1 x 3 dz	24.00 lb
430193	R447 0000 151C	Plate, Narrow Rim, 10½"	1 x 1 dz	24.80 lb
430195	R447 0000 359C	Platter, Oval, Narrow Rim, 11½"	1 x 1 dz	20.00 lb
457749	R448 0000 733C	Nappy, 5¾", 15 oz	1 x 3 dz	37.00 lb
430205	R448 0000 740C	Soup, Rim, 9", 12 oz	1 x 2 dz	42.10 lb
457751	R448 0000 560C	Mug, Concord, 8¾ oz	1 x 3 dz	30.00 lb

Sold in case pack only.



REGO® COLLECTION UNDECORATED NARROW RIM & ROLLED EDGE

- Bright white porcelain body with reinforced edge
- Narrow Rim is perfect for operations where grand servings of food are the trademark
- Rolled Edge will deliver years of service at the lowest possible replacement costs because of its clean lines and generous rims
- Limited 1 year no-chip warranty



Item #	Mfg. #	Description	Cs Pk	Cs Wt
Narrow Rim				
369045	R411 0000 111	Plate, 5½"	1 x 3 dz	19.10 lb
369046	R411 0000 118	Plate, 6¾"	1 x 3 dz	25.50 lb
371439	R411 0000 125	Plate, 7¼"	1 x 3 dz	34.00 lb
369037	R411 0000 139	Plate, 9"	1 x 2 dz	41.60 lb
369082*	R411 0000 150	Plate, 10¾"	1 x 1 dz	29.90 lb
369040	R411 0000 359	Oval Platter, 11½"	1 x 2 dz	56.00 lb
369024	R411 0000 710	Fruit, 4¾", 4½ oz	1 x 3 dz	16.40 lb
Rolled Edge				
369656	R413 0000 111	Plate, 5½"	1 x 3 dz	18.80 lb
369025	R413 0000 139	Plate, 9"	1 x 2 dz	37.80 lb
370928	R413 0000 145	Plate, 9¾"	1 x 2 dz	44.50 lb
369079	R413 0000 149	Plate, 10¼"	1 x 1 dz	24.80 lb
369659	R413 0000 790	Pasta Bowl, 11¾", 44 oz	1 x 1 dz	35.00 lb
369014	R413 0000 740	Rim Soup, 9", 11 oz	1 x 2 dz	42.10 lb
369063	R413 0000 700	Bouillon, U/H, 3¾", 7 oz	1 x 3 dz	26.40 lb
369053	R413 0000 711	Fruit, 4¾", 6¼ oz	1 x 3 dz	15.70 lb
369018	R413 0000 720	Grapefruit, 6½", 12 oz	1 x 3 dz	36.40 lb
369060	R413 0000 731	Nappy, 5¾", 13½ oz	1 x 3 dz	40.90 lb
369088	R413 0000 510	Cup, Vassar, 4", 7 oz	1 x 3 dz	26.00 lb
369085	R413 0000 500	Saucer, Vassar, 5½"	1 x 3 dz	21.60 lb
369059	R413 0000 560	Mug, Cafe, 4¼", 8 oz	1 x 3 dz	37.60 lb
369069	R413 0000 561	Mug, Union, 4½", 7½ oz	1 x 3 dz	42.00 lb
388585	R413 0000 562	C-Handle Mug, 4¾", 11 oz	1 x 3 dz	36.00 lb

Sold in case pack only. * Special order



ONEIDA®

Rolled Edge



Plate



Pasta Bowl



Rim Soup



Bouillon



Fruit



Grapefruit



Nappy

Narrow Rim



Fruit



Plate



Oval Platter



Vassar Cup



Vassar Saucer



Cafe Mug



Union Mug



C-Handle Mug

REGO® COLLECTION DUNES

- Neutral speckled brown body on beige background with - two brown bands

Item #	Mfg. #	Description	Cs Pk	Cs Wt
378402	R423 8026 125	Plate, N.R., 7¼"	1 x 3 dz	32.00 lb
378403	R423 8026 139	Plate, N.R., 9"	1 x 2 dz	42.40 lb
369072	R423 8026 143	Plate, N.R., 9½"	1 x 2 dz	42.30 lb
378404*	R423 8026 150	Plate, N.R., 10¾"	1 x 1 dz	29.90 lb
369042	R423 8026 359	Oval Platter, N.R., 11½"	1 x 2 dz	58.50 lb
378407	R423 8026 710	Fruit, N.R., 4¾", 4½ oz	1 x 3 dz	19.00 lb
378405	R423 8026 510	Cup, Vassar, 4¾", 7 oz	1 x 3 dz	29.10 lb
370849	R423 8026 501	Saucer, Salem, 5¾"	1 x 3 dz	26.10 lb
369050	R423 8026 560	Mug, Cafe, 4½", 8 oz	1 x 3 dz	37.60 lb

Sold in case pack only. * Special order



ONEIDA®



Plate



Oval Platter



Fruit, N.R.



Vassar Cup



Salem Saucer



Cafe Mug



DESERT SAND - ULTIMA®

• Dinnerware Collection – Narrow rim shape – Cream white with brown bands and speckles

Item #	Mfg. #	Description	Cs Pk	Cs Wt
397664	DSD-6	Plate, 6½"	1 x 3 dz	28.70 lb
397665	DSD-7	Plate, 7¼"	1 x 3 dz	38.60 lb
397666	DSD-8	Plate, 9"	1 x 2 dz	39.70 lb
397668	DSD-9	Plate, 9½"	1 x 2 dz	48.50 lb
397659	DSD-16	Plate, 10½"	1 x 1 dz	30.30 lb
397656	DSD-12	Oval Platter, 9½"	1 x 2 dz	32.00 lb
397657	DSD-13	Oval Platter, 11½"	1 x 1 dz	26.50 lb
397658	DSD-14	Oval Platter, 13¼"	1 x 1 dz	34.20 lb
397662	DSD-4	Bouillon, 7¼ oz	1 x 3 dz	24.20 lb
397655	DSD-11	Fruit, 4⅝", 4 oz	1 x 3 dz	18.70 lb
397654	DSD-10	Grapefruit, 6⅝", 13 oz	1 x 3 dz	39.70 lb
398954	DSD-15	Oatmeal, 5⅝", 12½ oz	1 x 3 dz	27.60 lb
397653	DSD-1	Cup, Tall, 7 oz	1 x 3 dz	27.00 lb
397661	DSD-2	Saucer, 6"	1 x 3 dz	23.10 lb
397660	DSD-17	Mug, Seville (Tiara), 8½ oz	1 x 3 dz	35.30 lb

Sold in case pack only.

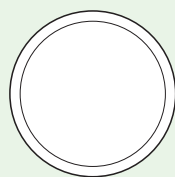

Plate

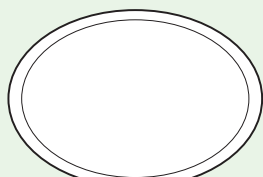

Platter

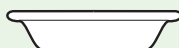

Grapefruit



Fruit



Bouillon



Oatmeal



Tall Cup



Seville Mug



Saucer



NARROW RIM PORCELANA

• Dinnerware Collection – Narrow rim shape – Undecorated white

Item #	Mfg. #	Description	Cs Pk	Cs Wt
397610	840-405N-10	Plate, 5½"	1 x 3 dz	18.00 lb
397614	840-410N-11	Plate, 6½"	1 x 3 dz	25.00 lb
397617	840-420N-12	Plate, 7¼"	1 x 3 dz	30.10 lb
397621	840-425N-13	Plate, 9"	1 x 2 dz	33.00 lb
397623	840-430N-14	Plate, 9½"	1 x 2 dz	39.45 lb
397624	840-440N-15	Plate, 10⅝"	1 x 2 dz	48.00 lb
469908*	840-520N-9	Oval Platter, 9¾"	1 x 2 dz	34.00 lb
397647	840-520N-17	Oval Platter, 11½"	1 x 1 dz	29.00 lb

Sold in case pack only. * Special order

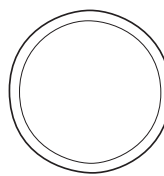

Plate

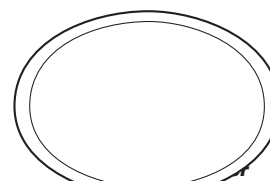

Oval Platter



SLATE

- Minimalist geometry and generous well space perfectly complement creative food presentations
- Ultra bright white porcelain

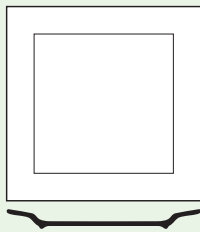

Plate

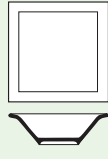

Fruit Bowl

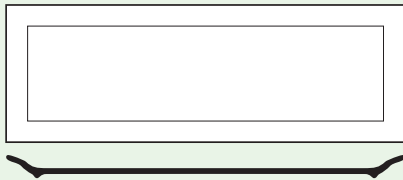

Rectangular Plate

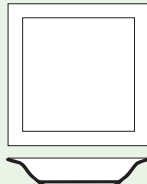

Pasta Bowl



Item #	Mfg. #	Description	Cs Pk	Cs Wt
464295	SL-6	Square Plate, 6 1/4"	1 x 3 dz	28.60 lb
469909	SL-7	Square Plate, 7 1/4"	1 x 2 dz	27.50 lb
464293	SL-9	Square Plate, 9"	1 x 1 dz	23.10 lb
464301	SL-10	Square Plate, 10 5/8"	1 x 1 dz	31.90 lb
488358	SL-40	Square Plate, 12"	1 x 6 ea	28.00 lb
464296	SL-20	Rectangular Plate, 8" x 5 5/8"	1 x 2 dz	25.30 lb
464297	SL-21	Rectangular Plate, 11" x 5"	1 x 1 dz	15.40 lb
461227	SL-22	Rectangular Plate, 16" x 5 1/2"	1 x 1 dz	26.40 lb
482579	SL-23	Rectangular Plate, 12" x 6"	1 x 1 dz	19.00 lb
467204*	SL-11	Square Fruit Bowl, 5", 5 1/2" oz	1 x 3 dz	24.26 lb
464298	SL-14	Square Pasta Bowl, 9 7/8", 30 oz	1 x 1 dz	33.07 lb

Sold in case pack only. * Special order

WORLD
TABLEWARE
A Libbey FOODSERVICE Company

VICEROY ULTIMA®

- Ultima® China
- Rolled edge shape
- Cream white color with dark green bands and lines

WORLD
TABLEWARE
A Libbey FOODSERVICE Company

Item #	Mfg. #	Description	Cs Pk	Cs Wt
398564	VIC-6	Plate, 6 5/8"	1 x 3 dz	28.00 lb
400973	VIC-7	Plate, 7 1/8"	1 x 3 dz	36.25 lb
397792	VIC-8	Plate, 9"	1 x 2 dz	42.00 lb
400974	VIC-9	Plate, 9 3/4"	1 x 2 dz	42.00 lb
397779	VIC-16	Plate, 10 1/4"	1 x 1 dz	28.10 lb
397778	VIC-13	Oval Platter, 11 1/2" x 8"	1 x 1 dz	29.45 lb
401735	VIC-14	Oval Platter, 12 1/2" x 8 3/4"	1 x 1 dz	33.45 lb
397791	VIC-4	Bouillon, 7 1/4 oz	1 x 3 dz	24.00 lb
397777	VIC-11	Fruit, 4 3/4", 4 3/4 oz	1 x 3 dz	23.00 lb
397783	VIC-3	Rim Soup, 8 3/4", 12 oz	1 x 2 dz	36.00 lb
397789	VIC-38	Mug, 7 1/2 oz	1 x 3 dz	31.05 lb

Sold in case pack only.

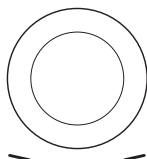

Plate

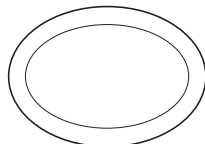

Platter



Rim Soup

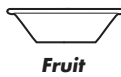

Fruit



Bouillon



Mug



ROLLED EDGE PORCELANA

- Rolled edge shape
- Bright white color

WORLD
TABLEWARE
A Libbey FOODSERVICE Company

Item #	Mfg. #	Description	Cs Pk	Cs Wt
Wide Rim				
397612*	840-405R-22	Plate, 5½"	1 x 3 dz	17.45 lb
397615	840-410R-23	Plate, 6¼"	1 x 3 dz	25.00 lb
397618	840-420R-24	Plate, 7⅛"	1 x 3 dz	33.15 lb
397622	840-425R-25	Plate, 9"	1 x 2 dz	33.00 lb
435274*	840-438R-10	Plate, 10½"	1 x 1 dz	27.56 lb
401566	840-445R-12	Plate, 12"	1 x 1 dz	36.00 lb
397649	840-520R-24	Oval Platter, Coupe, 11¾" x 8"	1 x 1 dz	28.00 lb
440321	840-530R-30	Oval Platter, Coupe, 13½" x 10"	1 x 1 dz	43.00 lb
522488*	840-520R-15	Oval Platter, 15½" x 10½"	1 x 6 ea	23.00 lb
397606	840-345-007	Bouillon, 7 oz	1 x 3 dz	21.00 lb
397602	840-310-020	Fruit, 4⅞", 3¾ oz	1 x 3 dz	16.00 lb
397607	840-350-035	Oatmeal Bowl, 5", 10 oz	1 x 3 dz	26.25 lb
397608	840-360-009	Oatmeal Bowl, 5⅝", 15 oz	1 x 3 dz	39.00 lb
397603	840-320-020	Grapefruit, 6⅜", 10 oz	1 x 3 dz	33.00 lb
397605	840-340-008	Rim Soup, 9", 13 oz	1 x 3 dz	60.00 lb
397609	840-370-200	Pasta Bowl, 12", 20 oz	1 x 1 dz	33.50 lb
397600	840-215-005	Saucer, Double Well, 5½"	1 x 3 dz	18.00 lb
397596	840-110-004	Cup, Tall, 7 oz	1 x 3 dz	23.00 lb
397597	840-116-101	Cup, Maui, Stacking, 7 oz	1 x 3 dz	24.00 lb
397599	840-125-002	Mug, Kona, 8½ oz	1 x 3 dz	30.00 lb

Sold in case pack only. * Special order



TABLETOP

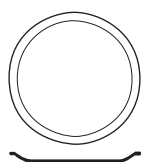

Plate

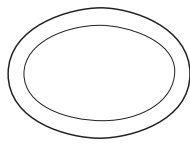

Oval Platter

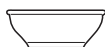

Oatmeal

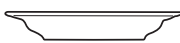

Pasta Bowl



Tall Cup



Stacking Cup



Kona Mug

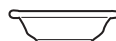

Fruit

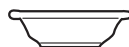

Grapefruit

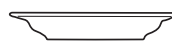

Rim Soup



Bouillon



Saucer



ENDURANCE

- Wide rim china with sculpted wheat pattern on rim
- Cream white porcelain

Item #	Mfg. #	Description	Cs Pk	Cs Wt
457510	END-6	Plate, 6¼"	1 x 3 dz	28.66 lb
457509	END-7	Plate, 7¼"	1 x 3 dz	29.77 lb
457519	END-9	Plate, 9"	1 x 2 dz	44.10 lb
457507	END-10	Plate, 10¼"	1 x 1 dz	26.46 lb
457520	END-18	Bouillon, Stacking, 7 oz	1 x 3 dz	22.05 lb
457505	END-20	Fruit, 5¾", 3½ oz	1 x 3 dz	19.84 lb
474976*	END-22	Grapefruit, 6⅜"	1 x 3 dz	28.66 lb
457504	END-24	Rim Soup, 9", 13 oz	1 x 3 dz	27.49 lb
457416*	END-26	Pasta Bowl, 12", 20 oz	1 x 1 dz	33.07 lb
457514	END-4	Coffee Cup, Stacking, 7 oz	1 x 3 dz	23.15 lb
457513	END-15	Saucer, 5½"	1 x 3 dz	22.05 lb
473717	END-3	Cup, Tall, 7 oz	1 x 3 dz	23.15 lb

Sold in case pack only. * Special order

WORLD
TABLEWARE
A Libbey FOODSERVICE Company

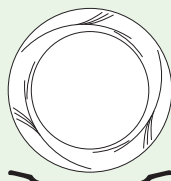

Plate



Fruit



Grapefruit

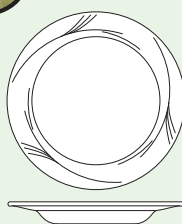

Pasta Bowl

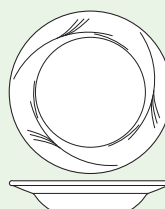

Rim Soup



Tall Cup



Stacking Cup



Bouillon



Saucer



KINGSMEN WHITE

- Ultima® China
- Narrow rim shape
- Cream white color

Item #	Mfg. #	Description	Cs Pk	Cs Wt
397679	NR-5	Plate, 5½"	1 x 3 dz	21.00 lb
397680	NR-6	Plate, 6½"	1 x 3 dz	29.00 lb
397681	NR-7	Plate, 7¼"	1 x 3 dz	36.00 lb
397682	NR-8	Plate, 9"	1 x 2 dz	45.00 lb
398903	NR-9	Plate, 9½"	1 x 2 dz	49.00 lb
397675	NR-16	Plate, 10½"	1 x 1 dz	27.00 lb
397672	NR-12	Oval Platter, 9¾" x 7½"	1 x 2 dz	36.35 lb
397673	NR-13	Oval Platter, 11½" x 9½"	1 x 1 dz	31.00 lb
397674	NR-14	Oval Platter, 13¼" x 10¼"	1 x 1 dz	41.00 lb
397671	NR-11	Fruit, 4⅝", 4 oz	1 x 3 dz	18.00 lb
397676	NR-2	Saucer, 5½"	1 x 3 dz	23.00 lb
397669	NR-1	Cup, Low, 7 oz	1 x 3 dz	27.00 lb

Sold in case pack only.

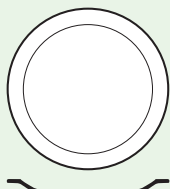

Plate

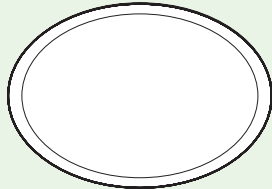

Platter



Fruit



Cup

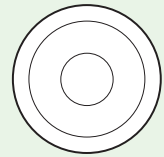

Saucer

WORLD
TABLEWARE
A Libbey FOODSERVICE Company

PRINCESS WHITE

- Ultima® China
- Rolled edge shape
- Cream white color

WORLD
TABLEWARE
A Libbey FOODSERVICE Company

Item #	Mfg. #	Description	Cs Pk	Cs Wt
399280	PWC-5	Plate, 5½"	1 x 3 dz	19.20 lb
397708	PWC-31	Plate, 6¼"	1 x 3 dz	25.00 lb
397714	PWC-6	Plate, 6⅝"	1 x 3 dz	31.00 lb
397729	PWC-7	Plate, 7⅞"	1 x 3 dz	35.00 lb
397731	PWC-8	Plate, 9"	1 x 2 dz	40.00 lb
397733	PWC-9	Plate, 9¾"	1 x 2 dz	44.00 lb
420900*	PWC-45	Plate, 10½"	1 x 1 dz	28.66 lb
410330	PWC-50	Plate, 12"	1 x 1 dz	41.30 lb
397701	PWC-16	Oval Platter, 8⅞" x 5¾"	1 x 3 dz	30.45 lb
397710	PWC-34	Oval Platter, 9⅝" x 6½"	1 x 2 dz	31.00 lb
397698	PWC-12	Oval Platter, 10⅝" x 7⅞"	1 x 2 dz	43.00 lb
397699	PWC-13	Oval Platter, 11½" x 8"	1 x 1 dz	25.00 lb
397700	PWC-14	Oval Platter, 12½" x 9"	1 x 1 dz	35.40 lb
464487	PWC-60	Oval Platter, 13½" x 9¾"	1 x 1 dz	33.07 lb
413835*	PWC-19	Oval Platter, 15½" x 10⅝"	1 x 6 ea	26.00 lb
397712	PWC-4	Bouillon, 7¼ oz	1 x 3 dz	24.00 lb
397709	PWC-32	Fruit, 4¼", 3 oz	1 x 3 dz	14.50 lb
397697	PWC-11	Fruit, 4¾", 4¾ oz	1 x 3 dz	16.45 lb
397705	PWC-24	Oatmeal, 5¼", 10 oz	1 x 3 dz	32.00 lb
397990	PWC-15	Oatmeal, 5⅝", 12½ oz	1 x 3 dz	35.35 lb
397702	PWC-18	Oatmeal, 5⅞", 16 oz	1 x 3 dz	41.00 lb
397695	PWC-10	Grapefruit, 6⅝", 13 oz	1 x 3 dz	32.00 lb
397706	PWC-3	Rim Soup, 8¾", 12 oz	1 x 2 dz	36.00 lb
487860*	PWC-40	Pasta Bowl, 11⅝", 22 oz	1 x 1 dz	32.00 lb
399817	PWC-39	Pasta Bowl, 12", 20 oz	1 x 1 dz	28.00 lb
397704	PWC-2	Saucer, 6"	1 x 3 dz	23.00 lb
397693	PWC-1	Cup, Tall, 7 oz	1 x 3 dz	27.20 lb
399753	RM-P-WP	Mug, 7 oz	1 x 3 dz	41.90 lb

*Sold in case pack only. * Special order*

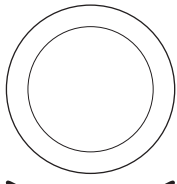

Plate

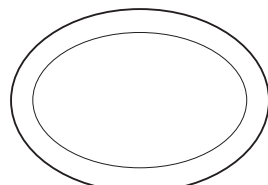

Oval Platter

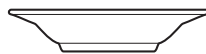

Rim Soup

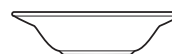

Grapefruit



Oatmeal



Bouillon

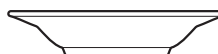

Pasta Bowl



Fruit

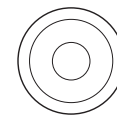

Saucer



Tall Cup



WELLINGTON ULTIMA®

- Dinnerware collection – Wellington shape
- Color: Cream White

Item #	Mfg. #	Description	Cs Pk	Cs Wt
397721	WEL-5	Plate, 5½"	1 x 3 dz	17.05 lb
397722	WEL-6	Plate, 6¾"	1 x 3 dz	24.45 lb
397724	WEL-7	Plate, 7½"	1 x 3 dz	31.00 lb
397725	WEL-8	Plate, 9¼"	1 x 2 dz	42.00 lb
397718	WEL-16	Plate, 10¼"	1 x 1 dz	23.10 lb
397720	WEL-4	Bouillon, 7 oz	1 x 3 dz	21.30 lb
397716	WEL-11	Fruit, 5", 4¾ oz	1 x 3 dz	17.45 lb
397713	WEL-10	Grapefruit, 6¾", 10 oz	1 x 3 dz	30.00 lb
400018*	WEL-3	Rim Soup, 9¼", 14¾ oz	1 x 2 dz	38.10 lb
397793	WEL-1	Cup, Low, 7 oz	1 x 3 dz	24.20 lb
397719	WEL-2	Saucer, 5½"	1 x 3 dz	20.45 lb

Sold in case pack only. * Special order

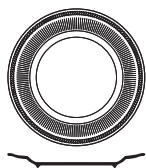

Plate

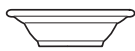

Grapefruit

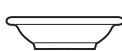

Fruit

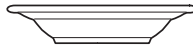

Rim Soup



Bouillon



Cup

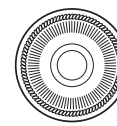

Saucer



CAFE ROYAL® CHINA

- Royal Rideau body
- Thin, light, low-profile pieces make stacking and handling easier than ever

Item #	Mfg. #	Description	Cs Pk	Cs Wt
508092	950041526	Plate, 6¾"	1 x 3 dz	20.00 lb
508091	950041521	Plate, 7¾"	1 x 3 dz	28.00 lb
508090	950041519	Plate, 10¾"	1 x 1 dz	24.00 lb
508083	950041080	Low Bouillon, 6¾ oz	1 x 3 dz	15.00 lb
508088	950041111	Tall Tea Cup, 7½ oz	1 x 3 dz	20.00 lb
508089	950041436	Tea Saucer, 5½"	1 x 3 dz	16.00 lb

Sold in case pack only.



Plate



Low Bouillon



Tall Tea Cup



Tea Saucer



SUGGESTED CHINA CARE

Avoid Thermal Shock: Taking china from cold chilled area and putting to use in oven or open heat could crack or warp china. Avoid chipping by taking care to remove one dish at a time from dishwasher. Save wear and tear on glaze by avoiding sliding dishes when stacking. Underside of non-glazed china foot will act like sand paper when sliding on to another plate. Proper quantities on hand allows for less wear and better rotation. Do not use metal scouring pads to remove stains or dried particles from china.

Avoiding Breakage: Do not stack cups one on top the other. Stack soiled dishes and clean dishes no more than 12 high. Are proper washing racks being used? Avoid stacking heavy weight china on top of light weight china. Use compartment racks where needed. Avoid carrying plates by hand or on arm to tables. Use separate bus boxes when bussing to clear table of china, glassware and flatware.



CASCADE™ CHINA

- Flint body – design patented
- Elegant white brings beauty and style to any dining decor

Item #	Mfg. #	Description	Cs Pk	Cs Wt
508118	950038261	Plate, 6¼"	1 x 3 dz	21.00 lb
508119	950038285	Plate, 7¼"	1 x 3 dz	31.00 lb
508120	950038310	Plate, 9"	1 x 1 dz	17.00 lb
508121	950038333	Plate, 10⅝"	1 x 1 dz	26.00 lb
508117	950038155	Fruit, 5", 3 oz	1 x 3 dz	15.00 lb
508115	950038059	Bouillon, Unhandled, 7 oz	1 x 3 dz	14.30 lb
508114	950038007	Grapefruit, 6⅜", 10 oz	1 x 3 dz	29.00 lb
508122	950038387	Rim Soup, 9", 14 oz	1 x 1 dz	19.00 lb
508116	950038127	Tall Tea Cup, 7 oz	1 x 3 dz	20.00 lb
508113	950038005	Mug, 8½ oz	1 x 3 dz	26.00 lb
508126	950038431	Tea Saucer, 5¾"	1 x 3 dz	18.00 lb

Sold in case pack only.



Plate



Unhandled Bouillon



Grapefruit



Tall Tea Cup



Mug



Mug

REFLECTIONS™ CHINA

- Bright white – twice fired china with a highly polished foot, available in Syracuse China's lighter and whiter Aluma White™ body
- Affordable for every basic restaurant use

Item #	Mfg. #	Description	Cs Pk	Cs Wt
508127	911194006	Plate, 6⅝"	1 x 3 dz	26.00 lb
508125	911194005	Plate, 7⅝"	1 x 3 dz	34.00 lb
508124	911194002	Plate, 10⅝"	1 x 1 dz	27.00 lb
508137	911194028	Fruit, 4⅝", 6 oz	1 x 3 dz	21.00 lb
508133	911194018	Bouillon, 9 oz	1 x 3 dz	16.00 lb
508129	911194007	Rim Soup, 9⅜", 13½ oz	1 x 1 dz	20.00 lb
508131	911194015	Tea Cup, 8 oz	1 x 3 dz	21.00 lb
508134	911194024	Tea Mug, 12½ oz	1 x 2 dz	22.00 lb
508132	911194017	Tea Saucer, 5⅞"	1 x 3 dz	20.00 lb

Sold in case pack only.



Plate



Bouillon



Rim Soup



Tea Cup



Tea Mug



Tea Saucer





SLENDA® CHINA

- Royal Rideau™ body shape
- Medium rim, flat profile with European style glazed foot
- Thinner, lighter body makes handling and stacking easier than ever

Item #	Mfg. #	Description	Cs Pk	Cs Wt
508139	905356832	Plate, 6¼"	1 x 3 dz	16.00 lb
508144	905356836	Plate, 7¼"	1 x 3 dz	22.00 lb
508138	905356825	Plate, 10½"	1 x 1 dz	18.00 lb
508148	905356894	Fruit Bowl, 5", 4 oz	1 x 3 dz	14.00 lb
508147	905356848	Stacking Bouillon, 3⅜", 8 oz	1 x 3 dz	23.00 lb
508142	905356835	Grapefruit Bowl, 6½", 11 oz	1 x 3 dz	26.00 lb
508145	905356840	Rim Soup, 9", 14 oz	1 x 1 dz	12.00 lb
Accessories - Undecorated				
508151	950002523	Fruit, 4⅞", 6 oz	1 x 3 dz	17.00 lb
508149	950002504	Low Tea Cup, 7½ oz	1 x 3 dz	20.00 lb
508150	950002505	Tall Tea Cup, 8½ oz	1 x 3 dz	22.00 lb
508152	950002589	Tea Saucer, 6¼"	1 x 3 dz	22.00 lb

Sold in case pack only.



Plate

Syracuse®
CHINA
A Libby FOODSERVICE Company



Fruit Bowl



Stacking Bouillon



Grapefruit Bowl



Rim Soup



Low Tea Cup



Tall Tea Cup

CANTINA® CHINA

- Versatile all around style is patterned after Arizona skies and southwestern jewels
- Combine with other colors to achieve a hot-looking contrast of hues
- Carved flint body

Item #	Mfg. #	Description	Cs Pk	Cs Wt
Blueberry				
508094	903032003	Plate, 7¼"	1 x 1 dz	13.20 lb
508096	903032010	Plate, 9"	1 x 1 dz	22.00 lb
508095	903032008	Platter, 11⅝"	1 x 1 dz	30.90 lb
508093	903032001	Platter, 13⅜"	1 x 6 ea	23.60 lb
Saffron				
508098	903033003	Plate, 7¼"	1 x 1 dz	13.20 lb
508100	903033010	Plate, 9"	1 x 1 dz	22.00 lb
508099	903033008	Platter, 11⅝"	1 x 1 dz	30.90 lb
508097	903033001	Platter, 13⅜"	1 x 6 ea	23.60 lb
Cayenne				
508102	903034003	Plate, 7¼"	1 x 1 dz	13.20 lb
508104	903034010	Plate, 9"	1 x 1 dz	22.00 lb
508103	903034008	Platter, 11⅝"	1 x 1 dz	30.90 lb
508101	903034001	Platter, 13⅜"	1 x 6 ea	23.60 lb
Sage				
508106	903035003	Plate, 7¼"	1 x 1 dz	13.20 lb
508108	903035010	Plate, 9"	1 x 1 dz	22.00 lb
508107	903035008	Platter, 11⅝"	1 x 1 dz	30.90 lb
508105	903035001	Platter, 13⅜"	1 x 6 ea	23.60 lb

Sold in case pack only.



OPAL RECEPTION

- Combines durability with refinement – its ivory color offers timeless appeal
- Wide range of shapes and sizes allows you to mix and match, creating a look and style uniquely your own
- Fully tempered and extra resistant
- Bone white



Item #	Mfg. #	Description	Cs Pk	Cs Wt
531627	47925	Plate, B & B, 6" dia	1 x 2 dz	12.00 lb
531628	47929	Plate, Salad/Dessert, 7 ⁵ / ₈ " dia	1 x 2 dz	17.00 lb
531624	47902	Plate, Lunch, 9 ⁵ / ₈ " dia	1 x 2 dz	26.00 lb
531621	47900	Plate, Dinner/Banquet, 10 ⁵ / ₈ " dia	1 x 2 dz	33.00 lb
531637	48087	Platter, Oval 11 ¹ / ₄ "	1 x 2 dz	31.00 lb
531639	48112	Dish, Le Grande, 11 ⁷ / ₈ " dia	1 x 1 dz	20.00 lb
531640	48201	Fruit Dish, 4 ¹ / ₂ ", 3 ¹ / ₂ oz	1 x 3 dz	11.00 lb
531653	55219	Bowl, Stacking, 4 ³ / ₄ ", 10 ¹ / ₂ oz	1 x 3 dz	17.00 lb
531466	05273	Bowl, Multi-Usage, 6 ¹ / ₄ ", 15 oz	1 x 2 dz	18.00 lb
531626	47913	Plate, Rim Soup, 8 ⁵ / ₈ ", 15 oz	1 x 2 dz	23.00 lb
531482	10887	Bowl, Pasta, 11 ¹ / ₄ ", 18 oz	1 x 1 dz	25.00 lb
531484	12558	Saucer, 6 ¹ / ₄ " dia, 6 ¹ / ₄ oz	1 x 3 dz	18.00 lb
531630	47982	Cup, Stacking, 8 oz	1 x 3 dz	21.00 lb
531641	48225	Cup, 7 ¹ / ₂ oz	1 x 3 dz	15.00 lb
531635	48025	Mug, 4 ¹ / ₄ " dia x 4" h, 9 ³ / ₄ oz	1 x 3 dz	20.00 lb

Sold in case pack only.



APPETIZER

- Add drama to your table with surprising serving ideas
- Unique shapes and styling offer a clever way to present appetizers, desserts and tasting size portions – mix and match shapes and styles
- Made of extra strong porcelain for increased durability
- Guaranteed 5 years against chips



Item #	Mfg. #	Description	Cs Pk	Cs Wt
531600	R0734	Mini Souffle, 2 ⁵ / ₈ " dia x 2" h, 3 ¹ / ₄ oz	1 x 2 dz	5.10 lb
531601	R0735	Deep Square Dish, 3 ³ / ₈ ", 4 ¹ / ₂ oz	1 x 2 dz	7.00 lb
531605	R0737	Plate, Square, 3 ⁵ / ₈ "	1 x 2 dz	4.00 lb
531603	R0736	Plate, Rectangular, 5 ⁵ / ₈ " dia x 2 ³ / ₄ " h	1 x 2 dz	6.00 lb
531606	R0738	Spoon, 4 ¹ / ₈ "	1 x 2 dz	2.00 lb
531618	R0744	Bowl, Ludico Low, 3 ¹ / ₄ ", 2 oz	1 x 2 dz	5.95 lb
531616	R0743	Bowl, Spiral, 3 ¹ / ₄ ", 3 ¹ / ₄ oz	1 x 2 dz	4.63 lb
531610	R0740	Bowl, Deep Oval, 3 ³ / ₈ ", 2 oz	1 x 2 dz	4.00 lb
531623	R0747	Bowl, Rim Square, 3 ⁷ / ₈ ", 2 ¹ / ₄ oz	1 x 2 dz	6.86 lb
531612	R0741	Bowl, Deep, 3 ³ / ₄ ", 5 oz	1 x 2 dz	6.00 lb
531614	R0742	Bowl, Deep, 4", 4 oz	1 x 2 dz	5.00 lb
531608	R0739	Bowl, 5 ⁵ / ₈ " dia	1 x 2 dz	4.00 lb
531620	R0745	Bowl, Wave Rectangular, 4 ¹ / ₄ ", 1 ¹ / ₂ oz	1 x 2 dz	6.39 lb
531622	R0746	Bowl, Wave Triangular, 4 ⁵ / ₈ ", 1 oz	1 x 2 dz	6.39 lb

Sold in case pack only.



INTENSITY



- This traditional design has an elegant, timeless and refined look
- Made of Zenix® a superior material engineered to preserve its long lasting flawless finish even through high usage venues
- High shock and scratch resistance
- 5 year chip and 10 year shape warranty

Item #	Mfg. #	Description	Cs Pk	Cs Wt
531590	G4394	Plate, B & B, 6¼"	1 x 2 dz	13.00 lb
531588	G4392	Plate, Banquet, 10"	1 x 2 dz	34.00 lb
531593	G4398	Plate, Dinner, 10¾"	1 x 2 dz	43.00 lb
531591	G4395	Plate, Service, 12"	1 x 1 dz	25.00 lb
531598	G4975	Platter, Oval, 13¾" x 10"	1 x 1 dz	25.00 lb
531592	G4396	Rim Soup/Pasta, 8½", 11¾ oz	1 x 2 dz	26.00 lb
531595	G4399	Pasta Bowl, 11", 38¾ oz	1 x 1 dz	25.00 lb

Sold in case pack only.



Plate



Platter



Rim Soup/Pasta



Pasta Bowl



TENDENCY

- Innovative organic shape inspired by the soft curves we see in nature
- Made of Zenix® a superior material with high shock and scratch resistance
- 5 year chip warranty

Item #	Mfg. #	Description	Cs Pk	Cs Wt
531597	G4765	Plate, Deep, 9", 15 oz	1 x 2 dz	23.00 lb
531562	G2277	Plate, 10½"	1 x 2 dz	29.00 lb
531586	G4375	Plate, 12¼"	1 x 1 dz	20.00 lb
531582	G4373	Plate, 12¼" x 10½"	1 x 1 dz	20.00 lb

Sold in case pack only.



#G4765



#G2277



#G4373

DARING

- This extra strong porcelain is practical and functional
- 5 year chip warranty

Item #	Mfg. #	Description	Cs Pk	Cs Wt
531578	G3754	Fruit Dish, 4½", 2½ oz	1 x 2 dz	8.00 lb
531573	G3751	Saucer, Double Well, 6"	1 x 2 dz	13.00 lb
531571	G3745	Cup, Stacking, 7¼ oz	1 x 2 dz	12.00 lb
531576	G3752	Mug, 10 oz	1 x 2 dz	17.00 lb

Sold in case pack only.



Plate



Cup & Saucer



Mug



OPAL RESTAURANT WHITE

- Stackable and extra tough – practical for high volume use
- Fully tempered and extra resistant



Item #	Mfg. #	Description	Cs Pk	Cs Wt
531533	22506	Plate, B & B, 6"	1 x 2 dz	12.00 lb
531481	58621	Plate, Narrow Rim, 6"	1 x 2 dz	12.00 lb
531473	57974	Plate, Side, Narrow Rim, 7½"	1 x 2 dz	19.00 lb
531544	22530	Plate, Side, 7½"	1 x 2 dz	19.00 lb
531542	22522	Plate, Lunch, 9¾"	1 x 2 dz	30.00 lb
531477	57975	Plate, Lunch, Narrow Rim, 9¼"	1 x 2 dz	30.00 lb
531554	24742	Plate, Dinner, 10"	1 x 2 dz	35.00 lb
531483	59943	Plate, Dinner, Narrow Rim, 10¼"	1 x 2 dz	37.00 lb
531556	25251	Platter, Oval, 11¼" x 8¾"	1 x 2 dz	35.00 lb
531564	25285	Fruit Dish, 4¾", 3½ oz	1 x 3 dz	12.00 lb
531587	43319	Bowl, Stacking, 4¾", 10½ oz	1 x 3 dz	17.00 lb
531565	25293	Bowl, Grapefruit, 6¼", 7 oz	1 x 3 dz	22.00 lb
531647	50061	Bowl, Multi-Usage, 6¼", 15 oz	1 x 2 dz	20.00 lb
531540	22514	Soup, Rim, 9", 23 oz	1 x 2 dz	30.00 lb
531567	28891	Bowl, Double Handled, 10½ oz	1 x 2 dz	17.00 lb
531557	G0320	Bowl, Pasta, 11¼", 18 oz	1 x 1 dz	25.00 lb
531548	22670	Saucer, 4¾"	1 x 4 dz	10.00 lb
531549	22712	Saucer, 5¾"	1 x 3 dz	21.00 lb
531546	22662	Cup, 2¾ oz	1 x 4 dz	13.00 lb
531486	14611	Cup, 8 oz	1 x 3 dz	21.00 lb
531561	25269	Cup, Tall, 7½ oz	1 x 4 dz	24.00 lb
531572	36140	Mug, 8 oz	1 x 3 dz	19.00 lb
531487	64733	Mug, 10 oz	1 x 3 dz	22.00 lb



Narrow Rim Plate

Plate



Oval Platter



Fruit



Stacking Bowl



Grapefruit



Multi-Usage Bowl



Rim Soup



Double Handled Bowl



Pasta Bowl



Cup & Saucer



Mug, 8 oz



Mug, 10 oz

OPAL® DINNERWARE *Also located on page 78.*

Opal® is the professional material of choice – from institutional dining and corporate feeding to high traffic restaurants. This fully recyclable product is the wave of the future. Light weight and perfectly stackable it makes handling within a catering or banqueting environment easy. Extremely scratch resistance and 100% hygienic. Three times stronger than any ceramic material, it can take the hard knocks of professional restaurants and facilities. Opal® is kind to your budget and the environment with surprisingly low installation costs and 30% less breakage.

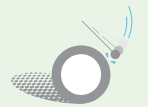

Extra Hard Surface
Long lasting protection against metal marking



Scratch Resistant
Long-lasting protection against knife scratches



Optimum Stacking
Perfectly exact profiles create neat stacking and storage



Heat Retentive
Keeps food hot – cools at the same speed as ceramic bodies



Fully Tempered
Extra strong for long life, durability and safety



Value
Surprisingly low installation costs and lower resupply cost than ceramic



Fade Resistance
Stands up to 2,000 industrial dishwashing cycles



100% Recyclable
Fully tempered glass is 100% recyclable material



Microwave Safe
Easy to use in microwave environments



Bacteria Free
100% non porous material all the way through, protects against bacteria

VISTA UNDECORATED

- Available in rolled edge and narrow rim
- Color: Bone White



Item #	Mfg. #	Description	Cs Pk	Cs Wt
Rolled Edge Shape				
534576	VRE-5	Plate, 5½"	1 x 3 dz	22.00 lb
534579	VRE-64	Plate, 6¼"	1 x 3 dz	24.00 lb
534581	VRE-6	Plate, 6⅝"	1 x 3 dz	28.00 lb
534584	VRE-7	Plate, 7⅛"	1 x 3 dz	33.00 lb
534586	VRE-8	Plate, 9"	1 x 2 dz	44.00 lb
534589	VRE-9	Plate, 9¾"	1 x 2 dz	48.00 lb
534592	VRE-16	Plate, 10½"	1 x 1 dz	26.00 lb
534594	VRE-21	Plate, 12"	1 x 1 dz	36.00 lb
534597	VRE-34	Platter, Oval, 9⅝"	1 x 2 dz	31.00 lb
534599	VRE-12	Platter, Oval, 10⅝"	1 x 2 dz	37.00 lb
534602	VRE-13	Platter, Oval, 11½"	1 x 1 dz	25.00 lb
534604	VRE-14	Platter, Oval, 12½"	1 x 1 dz	28.00 lb
Narrow Rim Shape				
534606	VNR-5	Plate, 5½"	1 x 3 dz	19.00 lb
534608	VNR-6	Plate, 6⅝"	1 x 3 dz	31.00 lb
534611	VNR-7	Plate, 7⅛"	1 x 3 dz	40.00 lb
534613	VNR-8	Plate, 9"	1 x 2 dz	43.00 lb
534614	VNR-9	Plate, 9¾"	1 x 2 dz	46.00 lb
534529	VNR-16	Plate, 10¾"	1 x 1 dz	28.00 lb
534530	VNR-12	Platter, Oval, 9½"	1 x 2 dz	36.00 lb
534532	VNR-13	Platter, Oval, 11½"	1 x 1 dz	30.00 lb
534534	VNR-14	Platter, Oval, 13¼"	1 x 1 dz	36.00 lb
Accessories for Narrow Rim & Rolled Edge Shape				
534545	VRE-4	Bouillon, 4", 8 oz	1 x 3 dz	24.00 lb
534547	VRE-32	Fruit, RE, 4½", 3½ oz	1 x 3 dz	15.00 lb
534549	VRE-11	Fruit, RE, 4¾", 5 oz	1 x 3 dz	18.00 lb
534554	VNR-11	Fruit, NR, 4⅝", 4 oz	1 x 3 dz	17.00 lb
534552	VRE-10	Grapefruit, 6⅝", 10 oz	1 x 3 dz	30.00 lb
534557	VRE-24	Nappy, 5¼", 10 oz	1 x 3 dz	29.00 lb
534558	VRE-15	Nappy, 5⅝", 12½ oz	1 x 3 dz	34.00 lb
534559	VRE-18	Nappy, 5⅞", 18 oz	1 x 3 dz	38.00 lb
534562	VRE-26	Deep Bowl, 10½", 8 oz	1 x 1 dz	27.00 lb
534565	VRE-27	Deep Bowl, 11½", 20 oz	1 x 1 dz	40.00 lb
534567	VRE-23	Deep Bowl, 12", 14 oz	1 x 1 dz	39.00 lb
534560	VRE-3	Pasta Bowl/Rim Soup, 9", 10 oz	1 x 2 dz	41.00 lb
534569	VRE-81	Pasta/Salad Bowl, 8½", 48 oz	1 x 1 dz	29.00 lb
534572	VRE-82	Pasta/Salad Bowl, 9", 60 oz	1 x 1 dz	33.00 lb
534533	VNR-2	Saucer, Royal, 5½"	1 x 3 dz	20.00 lb
534539	VRE-2	Saucer, Vista, 6⅞"	1 x 3 dz	23.00 lb
534543	VRE-36	Saucer, A.D., 5⅝"	1 x 3 dz	14.00 lb
534526	VRE-35	Cup, A.D. 3½ oz	1 x 3 dz	13.00 lb
534528	VRE-1	Cup, Tall, Vista, 7 oz	1 x 3 dz	24.00 lb
534531	VNT-V	Mug, Venture, 8 oz	1 x 3 dz	33.00 lb

Sold in case pack only.



TABLETOP

Rolled Edge



Plate



Oval Platter

Narrow Rim



Plate



Oval Platter

Accessories



Bouillon



Fruit, RE



Fruit, NR



Grapefruit



Nappy



Deep Bowl



Pasta Bowl/
Rim Soup



Pasta/Salad
Bowl



Royal
Saucer



Vista
Saucer



Saucer,
A.D.



Cup, A.D.



Vista Tall Cup



Venture Mug



SAUSALITO UNDECORATED

• With echoes of waves crashing against craggy shores, Sausalito features soft, flowing, sculpted lines

Item #	Mfg. #	Description	Cs Pk	Cs Wt
534653	SAU-6	Plate, 6¼"	1 x 3 dz	21.00 lb
534654	SAU-7	Plate, 7¼"	1 x 3 dz	31.00 lb
534656	SAU-8	Plate, 9"	1 x 2 dz	33.00 lb
534657	SAU-9	Plate, 9¾"	1 x 2 dz	36.00 lb
534659	SAU-16	Plate, 10¼"	1 x 1 dz	24.00 lb
534647	SAU-4	Bouillon, 3¾", 7 oz	1 x 3 dz	18.00 lb
534650	SAU-11	Fruit, 5¼", 5½ oz	1 x 3 dz	16.00 lb
534651	SAU-10	Grapefruit, 6¾", 11 oz	1 x 3 dz	25.00 lb
354652	SAU-3	Pasta Bowl/Rim Soup, 8½", 10 oz	1 x 2 dz	32.00 lb
534648	SAU-2	Saucer, 5½"	1 x 3 dz	16.00 lb
534646	SAU-1S	Cup, Stacking 3½", 8 oz	1 x 3 dz	19.00 lb

Sold in case pack only.



Plate



Bouillon



Fruit



Grapefruit



Pasta Bowl/
Rim Soup



Saucer



Stacking
Cup

WINDSOR UNDECORATED

• Sculptured rim design

Item #	Mfg. #	Description	Cs Pk	Cs Wt
534630	WIN-5	Plate, 5½"	1 x 3 dz	20.00 lb
534631	WIN-6	Plate, 6½"	1 x 3 dz	27.00 lb
534632	WIN-7	Plate, 7½"	1 x 3 dz	31.00 lb
534633	WIN-9	Plate, 9¾"	1 x 2 dz	43.00 lb
534635	WIN-16	Plate, 10¼"	1 x 1 dz	25.00 lb
534625	WIN-4	Bouillon, 3¾", 7 oz	1 x 3 dz	20.00 lb
534627	WIN-11	Fruit, 5", 4¾ oz	1 x 3 dz	17.00 lb
534628	WIN-10	Grapefruit, 6¾", 5½ oz	1 x 3 dz	33.00 lb
534629	WIN-3	Rim Soup, 9½", 14¾ oz	1 x 2 dz	48.00 lb
534626	WIN-2	Saucer, Windsor, 5¾"	1 x 3 dz	19.00 lb
534624	WIN-1	Cup, 3¾", 7 oz	1 x 3 dz	22.00 lb

Sold in case pack only.



Plate



Bouillon



Fruit



Grapefruit



Rim Soup



Saucer



Cup



ROYAL UNDECORATED

• Narrow rim

Item #	Mfg. #	Description	Cs Pk	Cs Wt
534641	RNR-5	Plate, 5½"	1 x 3 dz	18.00 lb
534643	RNR-6	Plate, 6½"	1 x 3 dz	27.00 lb
534644	RNR-7	Plate, 7¼"	1 x 3 dz	32.00 lb
534687	RNR-8	Plate, 9"	1 x 2 dz	39.00 lb
534645	RNR-16	Plate, 10½"	1 x 1 dz	27.00 lb
534637	RNR-12	Platter, Oval, 9½"	1 x 2 dz	37.00 lb
534639	RNR13	Platter, Oval, 11½"	1 x 1 dz	28.00 lb
534640	RNR-14	Platter, Oval, 13¼"	1 x 1 dz	35.00 lb
534636	RNR-11	Fruit, 4¾", 4¾ oz	1 x 3 dz	17.00 lb

Sold in case pack only.



Plate



Oval Platter



Fruit



CALIFORNIA SCALLOPED UNDECORATED

Item #	Mfg. #	Description	Cs Pk	Cs Wt
534616	CSC-6	Plate, 6 $\frac{3}{8}$ "	1 x 3 dz	25.00 lb
534617	CSC-7	Plate, 7 $\frac{3}{8}$ "	1 x 3 dz	31.00 lb
534619	CSC-8	Plate, 9"	1 x 2 dz	35.00 lb
534620	CSC-9	Plate, 9 $\frac{5}{8}$ "	1 x 2 dz	51.00 lb
534621	CSC-16	Plate, 10 $\frac{3}{4}$ "	1 x 1 dz	27.00 lb
534622	CSC-12	Platter, Oval, 9 $\frac{5}{8}$ "	1 x 2 dz	41.00 lb
534623	CSC-13	Platter, Oval, 11 $\frac{5}{8}$ "	1 x 1 dz	33.00 lb
534612	CSC-4	Bouillon, 4 $\frac{1}{8}$ ", 7 $\frac{1}{4}$ oz	1 x 3 dz	21.00 lb
534615	CSC-11	Fruit, 4 $\frac{7}{8}$ ", 4 $\frac{3}{4}$ oz	1 x 3 dz	18.00 lb
534609	CSC-2	Saucer, California, 5 $\frac{5}{8}$ "	1 x 3 dz	22.00 lb
534607	CSC-1	Cup, California, 7 $\frac{1}{4}$ oz	1 x 3 dz	26.00 lb

Sold in case pack only.



Plate



Oval Platter



Bouillon



Fruit



Saucer



Cup



CARAVAN BROWN UNDECORATED

- Speckled double band
- Narrow rim

Item #	Mfg. #	Description	Cs Pk	Cs Wt
534520	CRV-5	Plate, 5 $\frac{1}{2}$ "	1 x 3 dz	19.00 lb
534521	CRV-6	Plate, 6 $\frac{1}{2}$ "	1 x 3 dz	26.00 lb
534522	CRV-7	Plate, 7 $\frac{1}{4}$ "	1 x 3 dz	33.00 lb
534523	CRV-8	Plate, 9"	1 x 2 dz	27.00 lb
534524	CRV-9	Plate, 9 $\frac{1}{2}$ "	1 x 2 dz	42.00 lb
534525	CRV-16	Plate, 10 $\frac{1}{2}$ "	1 x 1 dz	28.00 lb
534517	CRV-12	Platter, Oval, 9 $\frac{1}{2}$ "	1 x 2 dz	36.00 lb
534518	CRV-13	Platter, Oval, 11 $\frac{1}{2}$ "	1 x 1 dz	28.00 lb
534519	CRV-14	Platter, Oval, 13 $\frac{1}{4}$ "	1 x 1 dz	36.00 lb
534512	CRV-4	Bouillon, 4", 7 $\frac{1}{4}$ oz	1 x 3 dz	22.00 lb
534513	CRV-11	Fruit, 4 $\frac{5}{8}$ ", 4 $\frac{3}{4}$ oz	1 x 3 dz	17.00 lb
534515	CRV-10	Grapefruit, 6 $\frac{3}{8}$ ", 10 $\frac{1}{2}$ oz	1 x 3 dz	41.00 lb
534516	CRV-15	Nappy, 5 $\frac{5}{8}$ ", 12 $\frac{1}{2}$ oz	1 x 3 dz	33.00 lb
534511	CRV-2	Saucer, Caravan, 6 $\frac{1}{8}$ "	1 x 3 dz	22.00 lb
534509	CRV-1	Cup, Tall, 3 $\frac{1}{4}$ ", 11 oz	1 x 3 dz	26.00 lb
534510	CRV-17	Mug, 3 $\frac{1}{8}$ ", 8 oz	1 x 3 dz	30.00 lb

Sold in case pack only.



Plate



Oval Platter



Bouillon



Fruit



Grapefruit



Nappy



Caravan Saucer



Tall Cup



Mug

ARGYLE & CATALINA UNDECORATED

• Bright European white body

Item #	Mfg. #	Description	Cs Pk	Cs Wt
Argyle Rolled Edge Shape				
534573	ARG-5	Plate, 5½"	1 x 3 dz	16.00 lb
534574	ARG-6	Plate, 6½"	1 x 3 dz	22.00 lb
534575	ARG-7	Plate, 7¼"	1 x 3 dz	18.00 lb
534577	ARG-8	Plate, 9"	1 x 2 dz	31.00 lb
534578	ARG-9	Plate, 9¾"	1 x 2 dz	40.00 lb
534580	ARG-16	Plate, 10¼"	1 x 1 dz	23.00 lb
534582	ARG-21	Plate, 12"	1 x 1 dz	33.00 lb
534583	ARG-12	Platter, 9¾"	1 x 2 dz	32.00 lb
534585	ARG-13	Platter, 11½"	1 x 1 dz	24.00 lb
Catalina Narrow Rim Shape				
534593	CAT-5	Plate, 5½"	1 x 3 dz	19.00 lb
534595	CAT-6	Plate, 6½"	1 x 3 dz	20.00 lb
534596	CAT-7	Plate, 7½"	1 x 3 dz	31.00 lb
534598	CAT-8	Plate, 9"	1 x 2 dz	33.00 lb
534600	CAT-16	Plate, 10½"	1 x 1 dz	26.00 lb
534588	CAT-12	Platter, Oval, 9¾"	1 x 2 dz	35.00 lb
534590	CAT-13	Platter, Oval, 11½"	1 x 1 dz	29.00 lb
534591	CAT-14	Platter, Oval, 13¼"	1 x 1 dz	40.00 lb
Accessories for Argyle & Catalina				
534561	CAT-4	Bouillon, 4", 7 oz	1 x 3 dz	17.00 lb
534563	ARG-11	Fruit, 4", 5 oz	1 x 3 dz	12.00 lb
534566	CAT-11	Fruit, 4⅝", 4¾ oz	1 x 3 dz	14.00 lb
534568	CAT-10	Grapefruit, 6⅝", 12 oz	1 x 3 dz	24.00 lb
534570	CAT-24	Nappy, 5¼", 10 oz	1 x 3 dz	22.00 lb
534571	CAT-18	Nappy, 5⅞", 16 oz	1 x 3 dz	40.00 lb
534556	ARG-2	Saucer, Argyle, 6"	1 x 3 dz	19.00 lb
534553	ARG-1	Cup, Tall, Argyle, 3", 7 oz	1 x 3 dz	23.00 lb
534555	VNT-P	Mug, Venture, 3⅞", 9 oz	1 x 3 dz	26.00 lb
534605	AST-3-P	3 Snuff Ashtray, Porcelain, 4½"	1 x 6 dz	28.00 lb

Sold in case pack only.



Argyle



Plate



Oval Platter

Catalina



Plate



Oval Platter

Accessories



Bouillon



Argyle Fruit



Catalina Fruit



Grapefruit



Nappy



Argyle Saucer



Argyle Tall Cup



Venture Mug



3 Snuff Ashtray

MUGS

- 8 oz capacity



Ventura, Bone White
Item #534531
Mfg. #VNT-V
Cs Pk 1 x 3 dz
Cs Wt 33.00 lb



Newport, Caramel
Item #534660
Mfg. #NPT-C
Cs Pk 1 x 3 dz
Cs Wt 36.00 lb

Sold in case pack only.

ULTIMA® MUGS

- Dinnerware Collection



Princess, 7 oz
Item #399753
Mfg. #RM-P-WP
White
Cs Pk 1 x 3 dz
Cs Wt 32.00 lb



Princess, 7 oz
Item #399751
Mfg. #RM-P-CP
Caramel
Cs Pk 1 x 3 dz
Cs Wt 34.00 lb



Mug, 12 oz
Item #492644
Mfg. #CM-12
Bright White
Cs Pk 1 x 1 dz
Cs Wt 13.00 lb



Tiara, 8½ oz
Item #397776
Mfg. #TM-8-W
White
Cs Pk 1 x 3 dz
Cs Wt 28.00 lb



Canton, 7½ oz
Item #490558
Mfg. #CA-75
White
Cs Pk 1 x 2 dz
Cs Wt 29.00 lb
Sold in case pack only.

MUGS

- Ceramic
- 8 oz capacity

ONEIDA®



Colgate, Brown
Item #369043
Mfg. #R4178102560
Cs Pk 1 x 3 dz
Cs Wt 37.60 lb



Colony, White
Item #426530
Mfg. #F1520000560
Cs Pk 1 x 3 dz
Cs Wt 30.70 lb

Sold in case pack only.

LONDON POT

- Lead-free china
- Lidless
- 16 oz capacity



Item #475574
Mfg. #82-OAWHA
White
Cs Pk 1 x 1 dz
Cs Wt 16.00 lb
Sold in case pack only.



The Hall China Company
Made in the U.S.A.

TRADITIONAL GOOSENECK SERVER

- Mirror-finished stainless steel
- Insulating hollow handle
- Large hinged cover
- Traditional styling
- 10 oz capacity



Item #371007
Mfg. #46310
Cs Pk 1 x 1 dz
Cs Wt 6.26 lb
Sold in case pack only.



Setting the Standard®

BELL CREAMERS

- Mirror-finished stainless steel
- Classic design
- Perfect for serving cream, sauces and dressings



Item #	Mfg. #	Description	Cs Pk	Cs Wt
368212	46003	3 oz	1 x 2 dz	3.42 lb
368249	46005	5 oz	1 x 1 dz	2.04 lb

Sold in case pack only.



BELL CREAMERS

- Stainless steel

Item #	Mfg. #	Description	Cs Pk	Cs Wt
482278	BC-3	3 oz	1 x 12 ea	1.50 lb
482279	BC-5	5 oz	1 x 12 ea	2.19 lb

Sold in case pack only.



CREAMER

- Mirror-finished stainless steel
- Wide gadroon base reduces the possibility of spilling
- Compact 5 oz size allows a smaller portion of cream at each table, maintaining freshness
- 3½" high

Item #379651
Mfg. #46205
Cs Pk 1 x 1 dz
Cs Wt 3.36 lb
Sold in case pack only.



CREAMER/PITCHER

- Made of dishwasher safe SAN
- White
- 3 oz, stain resistant



Item #397993
Mfg. #456302
Cs Pk 1 x 36 ea
Cs Wt 6.90 lb
Sold in case pack only.



EMPIRE CREAMER

- China
- White
- Handled
- 3½ oz

Item #475575
Mfg. #195-OAWHA
Cs Pk 1 x 2 dz
Cs Wt 11.00 lb
Sold in case pack only.



PDQ VALUELINE™ CREAMER

- China
- White
- 3½ oz

Item #476058
Mfg. #4539-OAWHA
Cs Pk 1 x 2 dz
Cs Wt 12.00 lb
Sold in case pack only.



The Hall China Company
Made in the U.S.A.



#CRE-3-PR



#CRE-6-V

CREAMERS

- Bone White

Item #	Mfg. #	Description	Cs Pk	Cs Wt
534603	CRE-3-PR	3 oz	1 x 3 dz	14.00 lb
534551	CRE-6-V	5 oz	1 x 2 dz	12.00 lb

Sold in case pack only.

SUGAR PACKET HOLDER

- China
- White
- 3½" x 2½" high

Item #534601
Mfg. #SPH-P
Cs Pk 1 x 4 dz
Cs Wt 30.00 lb
Sold in case pack only.



PDQ VALUELINE™ SUGAR HOLDER

- China
- White
- 2¼" high

Item #476059
Mfg. #4541-OAWHA
Cs Pk 1 x 2 dz
Cs Wt 16.00 lb
Sold in case pack only.



SUGAR PACKET HOLDER

- Made of SAN plastic
- Dishwasher safe
- 3½" x 2½", 2" deep
- Color: Black

Item #528121
Mfg. #SC-66-BK
Cs Pk 1 x 2 dz
Cs Wt 3.00 lb
Sold in case pack only.



SUGAR PACKET HOLDER

- Porcelain
- Bright White
- 2⅝" high

Item #498940
Mfg. #SPH-716-W
Cs Pk 1 x 4 dz
Cs Wt 29.00 lb
Sold in case pack only.



CARLISLE SUGAR CADDY

- Plastic
- Holds 20 packets
- Dishwasher safe
- Cs Pk 1 x 2 dz
- Cs Wt 5.25 lb

Item # **Mfg. #** **Description**
370047 455002 White
380737 455003 Black
Sold in case pack only.



SUGAR PACKET HOLDERS

4¼" glass
Item #369537
Mfg. #5460
Cs Pk 1 x 2 dz
Cs Wt 16.00 lb

Sold in case pack only.

3½" glass
Item #369183
Mfg. #5258
Cs Pk 1 x 2 dz
Cs Wt 11.00 lb

SUGAR PACKET HOLDER

- Clear plastic
- 3¼" x 2½", 2" deep

Item #397373
Mfg. #56C
Cs Pk 1 x 2 dz
Cs Wt 3.00 lb
Sold in case pack only.



CASABLANCA OVENWARE®

Item #	Mfg. #	Description	Cs Pk	Cs Wt
508109	950027733	Casserole w/2 Handles, Small, 10 oz	1 x 2 dz	24.00 lb
508110	950027739	Pot Pie, Medium, 9 oz	1 x 2 dz	20.00 lb
508111	950027742	Ramekin, Medium, 5 oz	1 x 3 dz	22.00 lb
508112	950027747	Welsh Rarebit, Small, 6 oz	1 x 2 dz	16.00 lb

Sold in case pack only.





#OAG-15-WW

WORLD
TABLEWARE
A Libbey FOODSERVICE Company



#OAG-12-WW



#OAG-8-WW

OVAL WELSH RAREBITS

- Cream White
- Cs Pk 1 x 2 dz

Item #	Mfg. #	Description	Cs Wt
522394	OAG-8-WW	8 oz	24.00 lb
397685	OAG-12-WW	12 oz	33.00 lb
413902	OAG-15-WW	15 oz	36.00 lb

Sold in case pack only.

PDQ VALUELINE™ OVENWARE

- Lead free china
- Fully vitrified



AU GRATIN

- White
- 7 oz capacity

Item #476061
Mfg. #4542-OAWHA
Cs Pk 1 x 2 dz
Cs Wt 22.00 lb
Sold in case pack only.

OVAL BAKER

- White
- 9 oz capacity

Item #476062
Mfg. #4544-OAWHA
Cs Pk 1 x 2 dz
Cs Wt 22.00 lb
Sold in case pack only.



Hall
The Hall China Company
Made in the U.S.A.

SHIRRED EGGS

- White
- Cs Pk 1 x 2 dz

Item #	Mfg. #	Description	Cs Wt
476055	4537-OAWHA	8 oz	25.00 lb
476056	4538-OAWHA	12 oz	28.00 lb

Sold in case pack only.

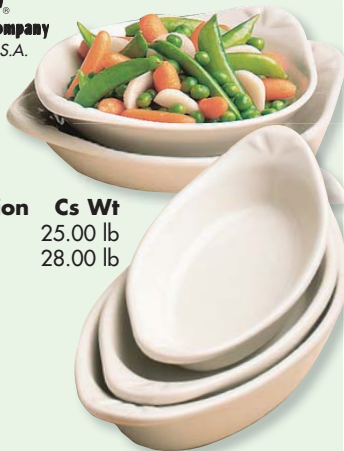

OVAL RAREBITS

- White
- Cs Pk 1 x 2 dz

Item #	Mfg. #	Description	Cs Wt
476052	4534-OAWHA	8 oz	24.00 lb
476053	4535-OAWHA	12 oz	34.00 lb
476054	4536-OAWHA	15 oz	37.00 lb

Sold in case pack only.

Hall
The Hall China Company
Made in the U.S.A.

RAREBITS/AU GRATINS

- Designed to distribute heat uniformly
- Oven-proof, freezer-proof and microwave-proof chinaware
- White
- Cs Pk 1 x 2 dz

Item #	Mfg. #	Description	Cs Wt
475617	527-OAWHA	8 oz	21.00 lb
475623	528-OAWHA	12 oz	29.00 lb

Sold in case pack only.

CREME BRULEE

- White
- 5 oz

Item #476064
Mfg. #4551-OAWHA
Cs Pk 1 x 2 dz
Cs Wt 14.00 lb
Sold in case pack only.



Hall
The Hall China Company
Made in the U.S.A.

CERAMIC OVENWARE

- Durability is the ultimate measure of quality
- Long wearing and more scratch resistant than plastic
- 32% more chip resistant than other chinaware
- Oval souffles make excellent creme brulee dishes

SOUFFLES

- White
- Cs Pk 1 x 2 dz

Item #	Mfg. #	Description	Cs Wt
475613	498-OAWHA	8 oz Fluted, Round	20.00 lb
476035	852-OAWHA	5 oz Fluted, Oval	15.00 lb
476036	853-OAWHA	6½ oz Fluted, Oval	19.00 lb
476040	864-OAWHA	8 oz Shallow, Round	17.00 lb

Sold in case pack only.

Hall
The Hall China Company
Made in the U.S.A.

CRÈME BRULEES

- Bright White
- Cs Pk 1 x 2 dz



4 oz, Oval
Item #481625
 Mfg. #CB-004
 Cs Wt 19.00 lb



8 oz, Round
Item #478916
 Mfg. #CB-080
 Cs Wt 27.00 lb

Sold in case pack only.



OVAL WELSH RAREBITS



Caramel
Item #534664
 Mfg. #WRO-8-C
 Cs Pk 1 x 3 dz
 Cs Wt 31.00 lb
Sold in case pack only.



Bone White
Item #534544
 Mfg. #WRO-10-V
 Cs Pk 1 x 2 dz
 Cs Wt 24.00 lb
Sold in case pack only.



Bone White
Item #534546
 Mfg. #WRO-12-V
 Cs Pk 1 x 2 dz
 Cs Wt 28.00 lb
Sold in case pack only.



#HS-12

HANDLED SKILLETS

- Bright White
- Cs Pk 1 x 1 dz

Item #	Mfg. #	Description	Cs Wt
520803	HS-12	12 oz	16.00 lb
487976	HS-18	18 oz	21.00 lb

Sold in case pack only.



#HS-18

REGO® ONION SOUP CROCK

- Earthtone ceramic exterior
- 4 1/8", 10 oz

ONEIDA®

Item #369057
 Mfg. #R417 0000 680
 Cs Pk 1 x 2 dz
 Cs Wt 25.00 lb
Sold in case pack only.



CASSEROLE W/HANDLES

- Bone White
- 6 3/8", 9 oz

Item #534548
 Mfg. #VRE-133
 Cs Pk 1 x 2 dz
 Cs Wt 25.00 lb
Sold in case pack only.



#OSC-15-H



#OSC-12



#OSC-15

ONION SOUP CROCKS

- 12 oz capacity
- Cs Pk 1 x 2 dz

Item #	Mfg. #	Description	Cs Wt
397689	OSC-12	Caramel	31.00 lb
397691	OSC-15	Caramel Beige	31.00 lb
397692	OSC-15-H	Caramel Beige w/Handle	31.00 lb

Sold in case pack only.



#OSC-10-V



#OSC-10-CB



#OSC-12-B

ONION SOUP CROCKS

- Cs Pk 1 x 2 dz

Item #	Mfg. #	Description	Cs Wt
534542	OSC-10-V	10 oz, Bone White	27.00 lb
534662	OSC-10-CB	10 oz, Brown/Caramel	25.00 lb
534663	OSC-12-B	12 oz, Solid Brown	29.00 lb

Sold in case pack only.

GLASS RAMEKINS

- Unique style combined with strength and durability
- DuraTuff® – increases resistance to thermal and mechanical shock



1 1/2 oz
Item #369432
Mfg. #15445
Cs Pk 1 x 3 dz
Cs Wt 4.00 lb

3 oz
Item #369260
Mfg. #15446
Cs Pk 1 x 3 dz
Cs Wt 7.00 lb

5 oz
Item #369470
Mfg. #15447
Cs Pk 1 x 3 dz
Cs Wt 12.00 lb

Sold in case pack only.



RAMEKINS

- Durability is the ultimate measure of quality
- Long wearing and more scratch resistant than plastic
- 32% more chip resistant than other chinaware
- White

Item #	Mfg. #	Description	Cs Pk	Cs Wt
475577	362-OAWHA	2 1/2 oz, Plain	1 x 3 dz	14.00 lb
475578	363-OAWHA	3 1/2 oz, Plain	1 x 3 dz	18.00 lb
475584	371-OAWHA	1 oz, Plain	1 x 6 dz	16.00 lb
476019	829-OAWHA	2 oz, Flared	1 x 3 dz	10.00 lb
476020	834-OAWHA	2 3/4 oz, Fluted	1 x 3 dz	12.00 lb
476021	834.5-OAWHA	4 oz, Fluted	1 x 3 dz	16.00 lb
476022	835-OAWHA	4 1/2 oz, Fluted	1 x 2 dz	13.00 lb
476023	839-OAWHA	5 oz, Fluted	1 x 2 dz	13.00 lb
476034	844-OAWHA	2 oz, Fluted	1 x 3 dz	10.00 lb

Sold in case pack only.



PDQ VALUELINE™ RAMEKINS

- Lead free
- Durable
- White
- Cs Pk 1 x 3 dz



Item #	Mfg. #	Description	Cs Wt
476048	4530-OAWHA	2 1/2 oz, Plain	14.00 lb
476049	4531-OAWHA	2 oz, Fluted	10.00 lb
476050	4532-OAWHA	2 1/2 oz, Fluted	13.00 lb
476051	4533-OAWHA	4 oz, Fluted	17.00 lb

Sold in case pack only.



RAMEKINS

- Fluted
- Bone White



Item #	Mfg. #	Description	Cs Pk	Cs Wt
534535	RMK-2-V	2 oz	1 x 6 dz	17.00 lb
534537	RMK-3-V	3 oz	1 x 4 dz	15.00 lb

Sold in case pack only.



MARDI GRAS™ RAMEKINS

- Break-resistant
- Made of durable melamine
- Dishwasher safe
- Cs Pk 1 x 4 dz



Item #	Mfg. #	Description	Cs Wt
528119	S-620-IV	Plain, 2 oz, Ivory	6.00 lb
531313	S-620-CB	Plain, 2 oz, Cobalt Blue	6.00 lb
528120	S-630-BK	Plain, 3 oz, Black	7.00 lb

Sold in case pack only.



MELAMINE RAMEKINS

- Perfect for all your sauces and dips
- Break resistant melamine
- Dishwasher safe
- Cs Pk 1 x 4 dz



Item #	Mfg. #	Description	Cs Wt
532955	RM-387-IV	Fluted, 2 oz, Ivory	6.00 lb
531307	RM-387-W	Fluted, 2 oz, White	6.00 lb
532956	RM-388-IV	Plain, 3 oz, Ivory	8.00 lb
531308	RM-388-BR	Plain, 3 oz, Brown	8.00 lb
528116	RM-388-MIX	Plain, 3 oz, Mardi Gras Mix Pack*	8.00 lb
531310	RM-400-BK	Plain, 4 oz, Black	9.00 lb
528117	RM-400-IV	Plain, 4 oz, Ivory	9.00 lb
531312	RM-401-BK	Fluted, 4 oz, Black	9.00 lb
528118	RM-401-IV	Fluted, 4 oz, Ivory	9.00 lb

Sold in case pack only.

*Mardi Gras Mix Pack consists of Rainforest Green, Rio Orange, Tropical Yellow and Peacock Blue colors only.

SAN RAMEKINS

- Great for sides and condiments
- Made of durable SAN material
- Dishwasher safe
- Cs Pk 1 x 4 dz



Item #	Mfg. #	Description	Cs Wt
1 1/4" Deep			
531305	ER-402-CL	Fluted, 2 oz, Clear	3.00 lb
1 1/2" Deep			
528106	ER-020-CL	Fluted, 2 oz, Clear	3.00 lb
528107	ER-020-W	Fluted, 2 oz, White	3.00 lb
528105	ER-020-BR	Fluted, 2 oz, Brown	3.00 lb
531301	ER-025-CL	Plain, 2 1/2 oz, Clear	3.00 lb
531302	ER-040-CL	Plain, 4 oz, Clear	4.00 lb
528108	ER-045-W	Fluted, 4 oz, White	5.00 lb

Sold in case pack only.



IVORY DIAMOND PLATE

- Soft, natural Ivory melamine dinnerware easily blends with any other color or pattern of dinnerware or decor
- Heavy glaze for superb stain resistance along with a 2 year limited breakage warranty
- Dishwasher safe
- 9" narrow rim

Item #531266

Mfg. #NP-9-DI

Cs Pk 1 x 2 dz

Cs Wt 17.00 lb

Sold in case pack only.



#F-625-BR

#F-625-IV

#SD-05-BK

RAMEKINS & SALSA DISH

- Made of durable melamine
- Dishwasher safe
- Cs Pk 1 x 4 dz



Item #	Mfg. #	Description	Cs Wt
529351	F-625-IV	Fluted Ramekin, 2 oz, Ivory	5.00 lb
528109	F-625-BR	Fluted Ramekin, 2 oz, Brown	5.00 lb
531314	SD-05-BK	Salsa Dish, 5 oz, Black	9.00 lb

Sold in case pack only.

MEDITERRANEAN™ PLATE

- Shatter-proof, dishwasher safe polycarbonate
- 8" dia
- Color: Clear

Item #531271

Mfg. #HI-2001-CL

Cs Pk 1 x 2 dz

Cs Wt 9.00 lb

Sold in case pack only.



#B-788-W



#B-789-BK

BARCELONA II BOWL

- Rimmed bowl is made of durable melamine
- Dishwasher safe
- 13 oz
- Color: Barcelona



Item #531353

Mfg. #DN-902-BA

Cs Pk 1 x 4 dz

Cs Wt 13.00 lb

Sold in case pack only.



SAN MICHELE™ CASCADING BOWLS

- Contemporary style
- Made of break-resistant melamine
- Dishwasher safe • Cs Pk 1 x 6 ea



Item #	Mfg. #	Description	Cs Wt
531316	B-788-BK	16 oz, Black	6.00 lb
531318	B-788-W	16 oz, White	6.00 lb
531322	B-789-BK	36 oz, Black	11.00 lb

Sold in case pack only.



#B-139-BK



BLACK ELEGANCE™ BOWLS

- Black melamine series tips a top hat to style and sophistication and provides an elegant background for food presentations
- Dishwasher safe

Item #	Mfg. #	Description	Cs Pk	Cs Wt
528087	B-139-BK	13 oz	1 x 2 dz	18.00 lb
528088	B-1611-BK	16 oz	1 x 1 dz	13.00 lb

Sold in case pack only.

DISPLAY TRAY

- Dishwasher safe melamine tray with scalloped edge
- 23" x 5 1/4"
- Color: White



Item #531261

Mfg. #ML-113-W

Cs Pk 1 x 1 dz

Cs Wt 21.00 lb

Sold in case pack only.





SUPERMEL 1™ DINNERWARE

NSF

- Super strong melamine with superior stain, scratch and break resistance
- Dishwasher safe, quick drying

Item #	Mfg. #	Description	Cs Pk	Cs Wt
White				
534397	DP-505-W	Plate, 5½"	1 x 4 dz	10.00 lb
528099	DP-506-W	Plate, 6½"	1 x 4 dz	14.00 lb
528102	DP-507-W	Plate, 7¼"	1 x 2 dz	9.00 lb
534399	DP-509-W	Plate, 9"	1 x 2 dz	12.00 lb
531348	DP-510-W	Plate, 10¼"	1 x 2 dz	14.00 lb
534401	OP-610-W	Platter, 10" x 6¾"	1 x 2 dz	10.00 lb
528112	OP-612-W	Platter, 11¾" x 8¼"	1 x 2 dz	14.00 lb
531328	BC-007-W	Bouillon Cup, 8 oz	1 x 4 dz	9.00 lb
528098	DN-335-W	Rimmed Bowl, 3½ oz	1 x 4 dz	6.00 lb
531346	DN-350-W	Rimmed Bowl, 5 oz	1 x 4 dz	8.00 lb
Tan				
534396	DP-505-T	Plate, 5½"	1 x 4 dz	10.00 lb
534398	DP-506-T	Plate, 6½"	1 x 4 dz	14.00 lb
528101	DP-507-T	Plate, 7¼"	1 x 2 dz	9.00 lb
528103	DP-509-T	Plate, 9"	1 x 2 dz	12.00 lb
528104	DP-510-T	Plate, 10¼"	1 x 2 dz	14.00 lb
534400	OP-610-T	Platter, 10" x 6¾"	1 x 2 dz	10.00 lb
528111	OP-612-T	Platter, 11¾" x 8¼"	1 x 2 dz	14.00 lb
531321	BC-007-T	Bouillon Cup, 8 oz	1 x 4 dz	9.00 lb
528097	DN-335-T	Rimmed Bowl, 3½ oz	1 x 4 dz	6.00 lb
531332	DN-350-T	Rimmed Bowl, 5 oz	1 x 4 dz	8.00 lb
528093	DN-313-T	Rimmed Bowl, 13 oz	1 x 4 dz	13.00 lb
528092	DN-310-T	Bowl, 10 oz	1 x 4 dz	12.00 lb
528094	DN-315-T	Bowl, 15 oz	1 x 4 dz	14.00 lb
528096	DN-316-T	Bowl, 16 oz	1 x 4 dz	15.00 lb

Sold in case pack only.

MILANO™ DINNERWARE

- Break-resistant melamine looks like china
- Dishwasher safe

Item #	Mfg. #	Description	Cs Pk	Cs Wt
531279	ML-60-W	Plate, Square, 6", White	1 x 1 dz	4.00 lb
531281	ML-61-BK	Plate, Square, 7¼", Black	1 x 1 dz	8.00 lb
531285	ML-61-W	Plate, Square, 7¼", White	1 x 1 dz	8.00 lb
531287	ML-62-W	Plate, Square, 8¾", White	1 x 1 dz	11.00 lb
531289	ML-63-BK	Plate, Square, 10¼", Black	1 x 1 dz	15.00 lb
531291	ML-63-W	Plate, Square, 10¼", White	1 x 1 dz	15.00 lb
531295	ML-82-W	Plate, Round, 10¼", White	1 x 1 dz	12.00 lb
531296	ML-84-BK	Plate, Round, 15", Black	1 x 6 ea	13.00 lb
531273	ML-10-W	Plate, Rectangular, 15" x 8", White	1 x 1 dz	17.00 lb
531275	ML-122-W	Side Dish, Square, 6 oz, White	1 x 1 dz	4.00 lb
531293	ML-77-W	Bowl, 24 oz, White	1 x 1 dz	7.00 lb

Sold in case pack only.

NSF

Plate, Square

Cs Pk	Cs Wt
1 x 1 dz	4.00 lb
1 x 1 dz	8.00 lb
1 x 1 dz	8.00 lb
1 x 1 dz	11.00 lb
1 x 1 dz	15.00 lb
1 x 1 dz	15.00 lb
1 x 1 dz	12.00 lb
1 x 6 ea	13.00 lb
1 x 1 dz	17.00 lb
1 x 1 dz	4.00 lb
1 x 1 dz	7.00 lb



Plate, Rectangular

Plate, Round

Side Dish, Square

Bowl

VENETIAN™ BOWL

- Beautifully designed melamine is durable and dishwasher safe
- 3 qt with rubber feet
- Color: Venetian

Item #531404
Mfg. #ML-94-VN

Cs Pk 1 x 6 ea
Cs Wt 13.00 lb
Sold in case pack only.



NSF



TRAYS

- Break-resistant durable melamine w/rubber feet
- Dishwasher safe
- Rectangular

Item #	Mfg. #	Description	Cs Pk	Cs Wt
531300	ML-88-VN	13¾" x 9½", Venetian™	1 x 6 ea	15.00 lb
531298	ML-87-W	17½" x 6¾", Milano™, White	1 x 6 ea	11.00 lb

Sold in case pack only.



#ML-87-W

#ML-88-VN

NSF



CAMBRO
TRUSTED FOR GENERATIONS™

NSF



- Dome Cover features patented plus-shaped handle for easy lifting.
- Thermal Warming Pellet maintains safe temperatures over 140°F for over 1 hour.
- Pellet Underliner holds pellet securely.



Pellet Lifter



#CLSB9-190

SHORELINE MEAL DELIVERY SYSTEM

- Features a contemporary look, high performance, and unequalled safety
- 9½" high-density plastic, thermal warming pellet
- Can be heated in a lowerator or a conventional oven
- Holds heat at its core to keep hot foods at safe temperatures for over 1 hour
- Stays 20°F cooler on the edge than metal pellets to protect staff and patients from burns
- Won't chip or dent like metal
- Stacks quietly to not disturb patients

Item #	Mfg. #	Description
482575	MDSM8-487	Mug, 8 oz
482576	MDSM8-497	Mug, 8 oz
501758	MDSM8-110	Mug, 8 oz
482567	MDSB5-487	Bowl, 5 oz Small
482568	MDSB5-497	Bowl, 5 oz Small
482569	MDSB9-487	Bowl, 9 oz Large
482570	MDSB9-497	Bowl, 9 oz Large
482571 †	MDSD9-487	Dome, Insulated, 9"
482572 †	MDSD9-497	Dome, Insulated, 9"
501755 †	MDSD9-110	Dome, Insulated, 9"
482573	MDSL9-487	Pellet Underliner, 9½"
482574	MDSL9-497	Pellet Underliner, 9½"
501757	MDSL9-110	Pellet Underliner, 9½"
482577	MDSP9-477	Pellet, Thermal, 9½"
502655 †	MDSPL	Pellet Lifter, 3½" OD x 3" high

Color	Cs Pk	Cs Wt
Cranberry	1 x 4 dz	12.96 lb
Navy Blue	1 x 4 dz	12.96 lb
Black	1 x 4 dz	12.96 lb
Cranberry	1 x 4 dz	7.82 lb
Navy Blue	1 x 4 dz	7.82 lb
Cranberry	1 x 4 dz	11.04 lb
Navy Blue	1 x 4 dz	11.04 lb
Cranberry	1 x 1 dz	10.92 lb
Navy Blue	1 x 1 dz	10.92 lb
Black	1 x 1 dz	10.92 lb
Cranberry	1 x 1 dz	5.15 lb
Navy Blue	1 x 1 dz	5.15 lb
Black	1 x 1 dz	5.15 lb
Dark Grey	1 x 1 dz	29.75 lb
Black/Red	1 x 1 ea	0.40 lb

Disposable CamLids®

501204	CLSM8B5-190	Small, Fits MDSM8 Mug or MDSB5 Bowl	Translucent	1 x 1500 ea	9.00 lb
501209	CLSB9-190	Large, Fits MDSB9 Bowl	Translucent	1 x 1000 ea	10.00 lb
501203	CLSSM8B5-148	Sip, Fits MDSM8 Mug or MDSB5 Bowl	White	1 x 1000 ea	7.00 lb

Sold in case pack only.

CAMLID® DISPOSABLE LIDS

- Fit tightly on tumblers or bowls
- Translucent (190), Clear (152)

Item #	Mfg. #	Description	Cs Pk	Cs Wt
For Newport Tumblers				
501196	CLNT5-190	Fits NT5	1 x 1500 ea	6.00 lb
501191	CLNT8-190	Fits NT8	1 x 1000 ea	7.00 lb
501211	CLNT10-190	Fits NT10	1 x 1000 ea	5.00 lb
For Laguna® Tumblers				
501197	CLLT6-190	Fits LT6	1 x 1500 ea	6.00 lb
501212	CLLT10-190	Fits LT10	1 x 1000 ea	5.00 lb
501200	CLLT12-190	Fits LT12	1 x 1000 ea	6.00 lb
For Colorware Tumblers				
501194	CL900P-190	Fits 900P & 900P2	1 x 1000 ea	6.00 lb
501193	CL950P-190	Fits 950P & 950P2	1 x 1000 ea	6.00 lb
For Swirl Bowl				
501206	CLSRB5-152	Fits 5 oz SRB5CW/SRB5	1 x 1000 ea	10.00 lb
For DineX Cup, Tumblers & Bowl				
501188	CLJ6-190	Fits 6 oz Juice Cup	1 x 1000 ea	3.00 lb
501192	CLST6-190	Fits 6 oz Swirl Tumbler	1 x 1000 ea	4.00 lb
501202	CLDHMT8-190	Fits 8 oz Heritage Tumbler	1 x 2000 ea	8.00 lb
501208	CLDHB9-190	Fits 9 oz Heritage Bowl	1 x 1000 ea	6.00 lb



#CLNT10-190



#CLLT12-190



#CL900P-190



#CLSRB5-152



#CL950P-190

Sold in case pack only.



W WEDGWOOD ONEIDA®

REFLECTIONS

- Reflections offers a clever combination of flared, geometric lines and bold angles
- Luxury, sophistication, craftsmanship – for centuries Wedgwood tabletop products have represented the ultimate in style and quality
- 18/10 stainless steel

Item #	Mfg. #	Description	Cs Pk	Cs Wt
444416	T672STSF	Teaspoon	1 x 1 dz	1.50 lb
466722	T672SRBF	Round Bowl Soup Spoon	1 x 1 dz	2.40 lb
444418	T672FDIF	European Table Fork	1 x 1 dz	2.40 lb
444419	T672FDEF	Salad/Dessert Fork	1 x 1 dz	1.80 lb
444420	T672KPTF	Table Knife, 1 pc	1 x 1 dz	4.00 lb

Sold in case pack only.

SCROLL

- Sweeping asymmetrical lines for the look and feel of craftsmanship with a touch of style
- Elegance with long lasting durability
- 18/10 stainless steel

Item #	Mfg. #	Description	Cs Pk	Cs Wt
381000	2201STSF	Teaspoon	1 x 3 dz	2.70 lb
381001	2201SBLF	Bouillon Spoon	1 x 3 dz	2.60 lb
381003	2201SITF	Iced Teaspoon	1 x 3 dz	2.60 lb
370706	2201FDNF	Dinner Fork	1 x 3 dz	3.40 lb
380999	2201FSLF	Salad/Pastry Fork	1 x 3 dz	3.10 lb
381005	2201KPVF	Dinner Knife, S.H., 1 pc	1 x 3 dz	7.20 lb

Sold in case pack only.

ONEIDA®



ONEIDA®

UNITY

- Classic architecture, symmetry and balance come together in a harmonious union to create this popular linear design
- Maximum protection against corrosion by food and cleaning chemicals
- 18/10 stainless steel

Item #	Mfg. #	Description	Cs Pk	Cs Wt
372908	2347STSF	Teaspoon	1 x 3 dz	2.70 lb
372904	2347SRBF	Round Bowl Soup Spoon	1 x 3 dz	3.90 lb
371472	2347FPLF	Dinner Fork	1 x 3 dz	3.90 lb
372903	2347FSLF	Salad/Pastry Fork	1 x 3 dz	3.40 lb
371471	2347KPVF	Dinner Knife, 1 pc	1 x 3 dz	9.20 lb

Sold in case pack only.

CHATEAU

- Made of 18/10 stainless steel
- Offers a traditional elegance with its shadow rose design

Item #	Mfg. #	Description	Cs Pk	Cs Wt
369009	2610STSF	Teaspoon	1 x 3 dz	2.40 lb
370687	2610SBLF	Bouillon Spoon	1 x 3 dz	3.00 lb
369003	2610FRSF	Dinner Fork	1 x 3 dz	2.90 lb
381011	2610FSLF	Salad/Pastry Fork	1 x 3 dz	2.10 lb
372506	2610KPVF	Dinner Knife, S.H., 1 pc	1 x 3 dz	5.50 lb

Sold in case pack only.



ONEIDA®

NEEDLEPOINT

- Like a strand of fine pearls, this classic 18/10 stainless pattern is always in style, always appropriate
- A delicate beaded border defines its graceful shape, bringing an air of casual elegance to your dining establishment
- Long lasting durability

Item #	Mfg. #	Description	Cs Pk	Cs Wt
369002	2544STSF	Teaspoon	1 x 3 dz	2.30 lb
369010	2544SBLF	Bouillon Spoon	1 x 3 dz	2.50 lb
369008	2544SPLF	Oval Bowl Soup/Dessert Spoon	1 x 3 dz	3.10 lb
381009	2544STBF	Tablespoon/Serving Spoon	1 x 1 dz	1.40 lb
369004	2544FRSF	Dinner Fork	1 x 3 dz	2.50 lb
370700	2544FSLF	Salad/Pastry Fork	1 x 3 dz	2.00 lb
368994	2544KPVF	Dinner Knife, 1 pc	1 x 3 dz	6.50 lb

Sold in case pack only.



ONEIDA®



ONEIDA®

MARQUETTE

- A uniquely classic design that features a beaded rim framed by distinctive flutes tip in quality 18/10 stainless for long-lasting durability

Item #	Mfg. #	Description	Cs Pk	Cs Wt
383021	2272STSF	Teaspoon	1 x 3 dz	2.60 lb
402769	2272SBLF	Bouillon Spoon	1 x 3 dz	2.40 lb
386183	2272FDIF	Dinner Fork	1 x 3 dz	3.70 lb
402771	2272FSLF	Salad/Pastry Fork	1 x 3 dz	2.80 lb
402773	2272KPVF	Dinner Knife, 1 pc	1 x 3 dz	6.40 lb

Sold in case pack only

ARBOR ROSE

- Smooth flowing scrolls accented with a prominent rose bud create a warm, traditional design in quality 18/10 stainless
- Pair this pretty flatware pattern with floral theme dinnerware or simple white tableware

Item #	Mfg. #	Description	Cs Pk	Cs Wt
369007	2552STSF	Teaspoon	1 x 3 dz	2.30 lb
372910	2552SBLF	Bouillon Spoon	1 x 3 dz	2.90 lb
369006	2552FRSF	Dinner Fork	1 x 3 dz	2.50 lb
372911	2552FSLF	Salad/Pastry Fork	1 x 3 dz	2.00 lb
369005	2552KPVF	Dinner Knife, S.H., 1 pc	1 x 3 dz	5.60 lb

Sold in case pack only.

ONEIDA®



ONEIDA®

NEW RIM

- A gently curving border reflects the simple elegance of this fine pattern
- Blends continental sizing with European styling
- Finely crafted in 18/10 stainless

Item #	Mfg. #	Description	Cs Pk	Cs Wt
383614	T015STSF	Teaspoon, U.S. Size	1 x 1 dz	0.90 lb
409446	T015SBLF	Bouillon Spoon	1 x 1 dz	1.00 lb
383609	T015SDEF	Oval Bowl Soup/Dessert Spoon	1 x 1 dz	1.50 lb
383607	T015SITF	Iced Teaspoon	1 x 1 dz	0.90 lb
371521	T015SADF	Coffee Spoon, A.D.	1 x 1 dz	0.60 lb
409449	T015STBF	Tablespoon/Serving Spoon	1 x 1 dz	1.90 lb
413794	T015FDEF	Dinner Fork	1 x 1 dz	1.40 lb
409447	T015FDIF	Dinner Fork, European Size	1 x 1 dz	1.70 lb
383606	T015FOYF	Oyster/Cocktail Fork	1 x 1 dz	0.70 lb
371522	T015FSLF	Salad/Pastry Fork	1 x 1 dz	1.10 lb
434741	T015KSBG	Butter Knife, 1 pc	1 x 1 dz	1.90 lb
409448	T015KDVF	Table Knife	1 x 1 dz	2.90 lb

Sold in case pack only.



ORION

- This multi-dimensional flatware design is highlighted by a rounded, raised central panel that tapers slightly near the shank
- A simple yet sophisticated pattern
- 18% chrome stainless steel

Item #	Mfg. #	Description	Cs Pk	Cs Wt
415321	B120STSF	Teaspoon	1 x 3 dz	2.40 lb
415320	B120FDNF	Dinner Fork	1 x 3 dz	3.40 lb
415319	B120KPTF	Dinner Knife, 1 pc	1 x 3 dz	6.80 lb

Sold in case pack only.

BAGUETTE

- A teardrop-shaped handle is divided into two identical panels by a vertical ridge line, reflecting contemporary flair
- 18/10 stainless steel

Item #	Mfg. #	Description	Cs Pk	Cs Wt
414112	T148STSF	Teaspoon, U.S. Size	1 x 1 dz	1.00 lb
414116	T148SITF	Iced Teaspoon	1 x 1 dz	0.90 lb
419333	T148SADF	Coffee Spoon, A.D.	1 x 1 dz	0.50 lb
414115	T148SDEF	Oval Bowl Soup/Dessert Spoon	1 x 1 dz	1.60 lb
419331	T148FDEF	Dinner Fork	1 x 1 dz	1.30 lb
414118	T148FDIF	Dinner Fork, European Size	1 x 1 dz	2.00 lb
419332	T148FOYF	Oyster/Cocktail Fork	1 x 1 dz	0.70 lb
414117	T148FSLF	Salad/Pastry Fork	1 x 1 dz	0.90 lb
420853	T148KBBF	Butter Knife	1 x 1 dz	1.40 lb
414119	T148KPSG	Dinner Knife, H.H.	1 x 1 dz	3.00 lb
420852	T148KDVF	Table Knife, 1 pc	1 x 1 dz	3.50 lb

Sold in case pack only.



CORELLI

- Noted for its smooth graceful form accented by a dimensional band at the tapered neck of the handle
- This elegant pattern, crafted in an extra large heavy gauge format, presents an impressive tabletop statement for fine dining
- 18/10 stainless steel

Item #	Mfg. #	Description	Cs Pk	Cs Wt
433223	T168STSF	Teaspoon	1 x 1 dz	1.20 lb
433225	T168FDIF	European Table Fork	1 x 1 dz	2.00 lb
446312	T168FDEF	Salad/Dessert Fork	1 x 1 dz	1.30 lb
433226	T168KPTF	Table Knife, 1 pc	1 x 1 dz	3.70 lb

Sold in case pack only.

ONEIDA™

GREYSTOKE™

- In this classic colonial design adaptation, a broad central panel is tastefully flanked by slender pillars, culminating in an arched handle tip
- This affordable flatware design sets the standard for both durability and value
- 18% chrome stainless steel

Item #	Mfg. #	Description	Cs Pk	Cs Wt
420386	B080STSF	Teaspoon	1 x 3 dz	2.60 lb
420382*	B080SBLF	Bouillon Spoon	1 x 3 dz	2.40 lb
420379	B080FPLF	Dinner Fork	1 x 3 dz	3.40 lb
420381	B080KPVF	Dinner Knife, 1 pc	1 x 3 dz	6.30 lb

*Sold in case pack only. * Special Order*





ONEIDA®

VILLAGE COMMON™

- This intriguing flatware design features a tapered, paddle-shaped handle with a slightly raised center
- A carved crest at the tip end adds visual balance to the brightly polished tines and bowls
- 18% chrome stainless steel

Item #	Mfg. #	Description	Cs Pk	Cs Wt
368999	B393STSF	Teaspoon	1 x 3 dz	2.10 lb
370686	B393SBLF	Bouillon Spoon	1 x 3 dz	2.50 lb
368974	B393FPLF	Dinner Fork	1 x 3 dz	2.90 lb
370684	B393KPVF	Dinner Knife, 1 pc	1 x 3 dz	5.20 lb

Sold in case pack only.

BARCELONA™

- Smooth, rounded curves taper to slender shafts, giving Barcelona a warm, comfortable feel
- The perfectly polished, tear-drop shaped handle feels as good in the hand as it looks on your tables
- 18% chrome stainless steel

Item #	Mfg. #	Description	Cs Pk	Cs Wt
424866	B169STSF	Teaspoon	1 x 3 dz	2.60 lb
424865	B169SRBF	Round Bowl Soup Spoon	1 x 3 dz	3.50 lb
423210	B169SDEF	Oval Bowl Soup/Dessert Spoon	1 x 3 dz	3.80 lb
415356	B169FDIF	Table Fork, European Size	1 x 3 dz	4.60 lb
423209	B169FDEF	Salad/Dessert Fork	1 x 3 dz	2.90 lb
424858	B169KPTF	Table Knife, 1 pc.	1 x 3 dz	7.40 lb

Sold in case pack only.



ONEIDA®



ONEIDA®

STANFORD™

- A fluted border defines the handle and gives Stanford a classic look
- Your patron's will admire this brightly polished design for its simple styling and quality finish
- 18% chrome stainless steel

Item #	Mfg. #	Description	Cs Pk	Cs Wt
424857	B167STSF	Teaspoon	1 x 3 dz	3.60 lb
423213	B167SRBF	Bouillon Spoon	1 x 3 dz	2.30 lb
424852	B167FDEF	Dinner/Dessert Fork	1 x 3 dz	3.90 lb
424853	B167FDNF	Dinner Fork	1 x 3 dz	5.30 lb
424855	B167KPTF	Dinner Knife, 1 pc	1 x 3 dz	7.90 lb

Sold in case pack only.

MIDLAND™

- Midland's understated lines and bright 18% chrome mirror finish blend effortlessly with any décor
- Pair this practical pattern with virtually any casual dinnerware
- 18% chrome stainless steel §

Item #	Mfg. #	Description	Cs Pk	Cs Wt
427880	B196STSF	Teaspoon	12 x 3 dz	26.80 lb
432488	B196SBLF	Bouillon Spoon	12 x 3 dz	26.80 lb
427635	B196FPLF	Dinner Fork	12 x 3 dz	31.00 lb
427873	B196KPVF	Dinner Knife, 1 pc	6 x 3 dz	29.10 lb

Sold in case pack or inner pack.

§ Except knives which are type 420 stainless steel.

ONEIDA®





DELCO
ONEIDA®

OLD ENGLISH™

- Colonial styling marked by the distinctive three-tined fork make this a popular pattern
- 18% chrome stainless steel

Item #	Mfg. #	Description	Cs Pk	Cs Wt
389623	B817STSF	Teaspoon	12 x 3 dz	28.30 lb
389620	B817SBLF	Bouillon Spoon	12 x 3 dz	28.40 lb
389622	B817SPLF	Oval Bowl Soup/Dessert Spoon	12 x 3 dz	33.30 lb
389621	B817SITF	Iced Teaspoon	12 x 3 dz	30.00 lb
389616	B817FDNF	Dinner Fork, 3 Tine	12 x 3 dz	32.00 lb
389482	B817FDNG	Dinner Fork, 4 Tine	12 x 3 dz	32.20 lb
389617	B817FOYF	Oyster/Cocktail Fork	12 x 3 dz	20.40 lb
389483	B817FSLG	Salad/Pastry Fork, 3 Tine	12 x 3 dz	26.20 lb
389624	B817KSHF	Steak Knife, H.H.	6 x 3 dz	32.60 lb
389625	B817KPVF	Dinner Knife, 1 pc	6 x 3 dz	38.40 lb
389619	B817KPWF	Dinner Knife, H.H., Pistol	6 x 3 dz	34.60 lb

Sold in case pack or inner pack.

DELTA™

- Smooth border lines moving to the midpoint of the handle provide a subtle accent on a popular shape
- 18% chrome stainless steel§

Item #	Mfg. #	Description	Cs Pk	Cs Wt
389463	B760STSF	Teaspoon	12 x 3 dz	23.50 lb
389460	B760SBLF	Bouillon Spoon	12 x 3 dz	25.00 lb
389461	B760SDEF	Oval Bowl Soup/Dessert Spoon	12 x 3 dz	31.90 lb
389462	B760SITF	Iced Teaspoon	12 x 3 dz	36.00 lb
389455	B760FDNF	Dinner Fork	12 x 3 dz	32.10 lb
431611	B760KPVF	Dinner Knife, 1 pc	6 x 3 dz	31.00 lb

Sold in case pack or inner pack.

§ Except knives which are type 420 stainless steel.

DELCO
ONEIDA®



DELCO
ONEIDA®

BELMORE™

- Reminiscent of a single strand of pearls, Belmore offers timeless appeal with its slender shaft and prominent beaded border
- 18% chrome stainless steel§

Item #	Mfg. #	Description	Cs Pk	Cs Wt
389426	B561STSF	Teaspoon	12 x 3 dz	25.40 lb
389423	B561SBLF	Bouillon Spoon	12 x 3 dz	23.60 lb
389425	B561SPLF	Oval Bowl Soup/Dessert Spoon	12 x 3 dz	35.70 lb
389419	B561FDNF	Dinner Fork	12 x 3 dz	29.40 lb
389421	B561FSLF	Salad/Pastry Fork	12 x 3 dz	20.10 lb
389422	B561KPNF	Dinner Knife, 1 pc.	6 x 3 dz	38.00 lb

Sold in case pack or inner pack.

§ Except knives which are type 420 stainless steel.

LEXINGTON™

- The Lexington pattern pleases with its straight-forward styling and economical price
- Completely free of ornamentation, this flatware complements many table settings
- 18% chrome stainless steel§

Item #	Mfg. #	Description	Cs Pk	Cs Wt
389370	B070STSF	Teaspoon	12 x 3 dz	26.00 lb
389367	B070SBLF	Bouillon Spoon	12 x 3 dz	23.20 lb
389369	B070SPLF	Oval Bowl Soup/Dessert Spoon	12 x 3 dz	31.40 lb
389357	B070FPLF	Dinner Fork	12 x 3 dz	41.50 lb
389358	B070KPVF	Dinner Knife, 1 pc	6 x 3 dz	33.00 lb

Sold in case pack or inner pack.

§ Except knives which are type 420 stainless steel.

DELCO ONEIDA®



PRIMA™

- Prima features a delicate beaded border highlighting its gently rounded handles
- 18% chrome stainless steel

Item #	Mfg. #	Description	Cs Pk	Cs Wt
381361	B595STSF	Teaspoon	12 x 3 dz	37.60 lb
381359	B595SBLF	Bouillon Spoon	12 x 3 dz	38.50 lb
381360	B595SDEF	Oval Bowl Soup/Dessert Spoon	12 x 3 dz	60.80 lb
381362	B595SITF	Iced Teaspoon	12 x 3 dz	33.10 lb
381354	B595FDNF	Dinner Fork	12 x 3 dz	51.00 lb
381355	B595FOYF	Oyster/Cocktail Fork	12 x 3 dz	27.10 lb
381356	B595FSLF	Salad/Pastry Fork	12 x 3 dz	33.50 lb
381357	B595KPVF	Dinner Knife, 1 pc	6 x 3 dz	42.00 lb
381358	B595KSBF	Butter Spreader, F.H.	6 x 3 dz	18.50 lb

Sold in case pack or inner pack.



DELCO ONEIDA®

LAGUNA™

- The Laguna pattern offers the ever-popular shell motif at an attractive price point
- 18% chrome stainless steel§

Item #	Mfg. #	Description	Cs Pk	Cs Wt
381372	B606STSF	Teaspoon	12 x 3 dz	37.60 lb
381370	B606SBLF	Bouillon Spoon	12 x 3 dz	37.70 lb
381371	B606SDEF	Oval Bowl Soup Spoon	12 x 3 dz	52.50 lb
381373	B606SITF	Iced Teaspoon	12 x 3 dz	39.60 lb
381374	B606STBF	Serving Spoon	18 x 3 dz	34.00 lb
381365	B606FDNF	Dinner Fork	12 x 3 dz	52.80 lb
381366	B606FOYF	Oyster/Cocktail Fork	12 x 3 dz	28.00 lb
381367	B606FSLF	Salad/Pastry Fork	12 x 3 dz	36.00 lb
381368	B606KPVF	Dinner Knife, 1 pc	6 x 3 dz	36.50 lb

Sold in case pack or inner pack.

§ Except knives which are type 420 stainless steel.

MELINDA III™

- Melinda is a petite design featuring graceful scrolls and petals on a traditional shape
- 18% chrome stainless steel§

Item #	Mfg. #	Description	Cs Pk	Cs Wt
381382	B072STSF	Teaspoon	18 x 3 dz	35.90 lb
458249	B072SBLF	Bouillon Spoon	18 x 3 dz	37.40 lb
463749	B072SPLF	Oval Bowl Soup/Dessert Spoon	18 x 3 dz	50.20 lb
381383	B072SITF	Iced Teaspoon	18 x 3 dz	36.80 lb
463747	B072SADF	A.D. Coffee Spoon	18 x 3 dz	20.00 lb
381375	B072FPLF	Dinner Fork	18 x 3 dz	46.00 lb
463755	B072FOYF	Oyster/Cocktail Fork	18 x 3 dz	28.30 lb
394605	B072FSLF	Salad/Pastry Fork	18 x 3 dz	35.20 lb
381379	B072KPVF	Dinner Knife, 1 pc	8 x 3 dz	42.00 lb

Sold in case pack or inner pack. § Except knives which are type 420 stainless steel.



DELCO ONEIDA®



DELCO ONEIDA®

CONCORD™

- A classic shape free of ornamentation, Concord is an enduring favorite among fast-paced dining facilities
- 18% chrome stainless steel§

Item #	Mfg. #	Description	Cs Pk	Cs Wt
389400	B230STSF	Teaspoon	12 x 3 dz	26.20 lb
389398	B230SBLF	Bouillon Spoon	12 x 3 dz	29.10 lb
427883	B230SDEF	Oval Bowl Soup/Dessert Spoon	12 x 3 dz	40.30 lb
389399	B230SITF	Iced Teaspoon	12 x 3 dz	27.90 lb
389396	B230FPLF	Dinner Fork	12 x 3 dz	36.70 lb
427881	B230FOYF	Oyster/Cocktail Fork	12 x 3 dz	20.80 lb
427882	B230FSLF	Salad/Pastry Fork	12 x 3 dz	24.50 lb
389397	B230KPVF	Dinner Knife, 1 pc	6 x 3 dz	34.90 lb

Sold in case pack or inner pack.

§ Except knives which are type 420 stainless steel.



DELCO ONEIDA®

DOMINION III™

- A pair of incised lines narrow and tapered at the shaft, dividing the petite handle into three segments
- 18% chrome stainless steel§

Item #	Mfg. #	Description	Cs Pk	Cs Wt
Dominion III				
381402	B421STSF	Teaspoon	18 x 3 dz	30.00 lb
381400	B421SBLF	Bouillon Spoon	18 x 3 dz	30.30 lb
381401	B421SPLF	Oval Bowl Soup/Dessert Spoon	18 x 3 dz	37.00 lb
381403	B421SITF	Iced Teaspoon	18 x 3 dz	35.00 lb
381396	B421FPLF	Dinner Fork	18 x 3 dz	35.00 lb
381395	B421FOYF	Oyster/Cocktail Fork	18 x 3 dz	18.00 lb
381397	B421FSLF	Salad/Pastry Fork	18 x 3 dz	30.30 LB
381399	B421KGWF	Dinner Knife, 1 pc	8 x 3 dz	27.50 lb
Heavy Dominion				
389471	B763STSF	Teaspoon	18 x 3 dz	33.00 lb
389470	B763SBLF	Bouillon Spoon	18 x 3 dz	35.00 lb
427930	B763SITF	Iced Teaspoon	18 x 3 dz	48.20 lb
417779	B763FDIF	Dinner Fork	18 x 3 dz	47.00 lb
389469	B763KPVF	Dinner Knife, 1 pc	8 x 3 dz	36.00 lb

Sold in case pack or inner pack.

§ Except knives which are type 420 stainless steel.

WINDSOR III

- Windsor is an exercise in simplicity with its clean lines and smooth handle design
- 18% chrome stainless steel§

Item #	Mfg. #	Description	Cs Pk	Cs Wt
Windsor III				
381392	B401STSF	Teaspoon	18 x 3 dz	26.00 lb
381388	B401SBLF	Bouillon Spoon	18 x 3 dz	28.00 lb
381389	B401SPLF	Oval Bowl Soup/Dessert Spoon	18 x 3 dz	36.70 lb
381393	B401SITF	Iced Teaspoon	18 x 3 dz	34.00 lb
483935	B401STBF	Tablespoon/Serving Spoon	8 x 3 dz	28.00 lb
381385	B401FPLF	Dinner Fork	18 x 3 dz	32.40 lb
381384	B401FOYF	Oyster/Cocktail Fork	18 x 3 dz	21.30 lb
381386	B401FSLF	Salad/Pastry Fork	18 x 3 dz	28.80 lb
381387	B401KGWF	Dinner Knife, 1 pc	8 x 3 dz	27.70 lb
Heavy Windsor				
389475	B767STSF	Teaspoon	18 x 3 dz	33.30 lb
389474	B767SBLF	Bouillon Spoon	18 x 3 dz	34.00 lb
389576	B767SDEF	Oval Bowl Soup/Dessert Spoon	18 x 3 dz	42.00 lb
427933	B767SITF	Iced Teaspoon	18 x 3 dz	48.00 lb
389472	B767FDNF	Dinner Fork	18 x 3 dz	48.10 lb
389473	B767KPVF	Dinner Knife, 1 pc	8 x 3 dz	36.00 lb

Sold in case pack or inner pack.

§ Except knives which are type 420 stainless steel.



DELCO ONEIDA®



WORLD
TABLEWARE
A Libby FOODSERVICE Company

COLONY

- Brandware® 18/0 Collection
- Heavy weight
- Satin finish

Item #	Mfg. #	Description	Cs Pk	Cs Wt
398290	136-001	American Teaspoon	12 x 3 dz	33.20 lb
531088	136-016	Bouillon Spoon	12 x 3 dz	44.65 lb
531087	136-002	Dessert Spoon	12 x 3 dz	36.85 lb
531089	136-021	Iced Teaspoon	12 x 3 dz	40.30 lb
531137	136-030	Dinner Fork	12 x 3 dz	40.30 lb
531147	136-038	Salad Fork	12 x 3 dz	30.15 lb
531090	136-5262	Dinner Knife, Fl. Bl., S.H.	18 x 1 dz	36.10 lb

Sold in case pack or inner pack.

REGENCY

- Brandware® 18/10 Collection
- Heavy weight

Item #	Mfg. #	Description	Cs Pk	Cs Wt
466579	135-001	Teaspoon	1 x 3 dz	2.16 lb
466580	135-016	Bouillon Spoon	1 x 3 dz	2.15 lb
466581	135-021	Iced Teaspoon	1 x 3 dz	2.31 lb
466582	135-030	Dinner Fork	1 x 3 dz	2.79 lb
466583	135-5262	Dinner Knife, 1 pc	1 x 1 dz	2.12 lb

Sold in case pack only.



WORLD
TABLEWARE
A Libbey FOODSERVICE Company



LINDA

- Brandware® 18/0 Collection
- Heavy weight

Item #	Mfg. #	Description	Cs Pk	Cs Wt
531297	134-001	American Teaspoon	24 x 3 dz	48.75 lb
531284	134-016	Bouillon Spoon	12 x 3 dz	24.85 lb
531288	134-002	Dessert Spoon	12 x 3 dz	34.95 lb
531141	134-030	Dinner Fork	12 x 3 dz	30.60 lb
531151	134-038	Salad Fork	12 x 3 dz	22.68 lb
531280	134-5262	Dinner Knife, Fl. Bl., S.H.	18 x 1 dz	30.65 lb

Sold in case pack or inner pack.

WORLD
TABLEWARE
A Libbey FOODSERVICE Company

CORAL

- Brandware® 18/0 Collection
- Extra heavy weight

Item #	Mfg. #	Description	Cs Pk	Cs Wt
531093	127-001	American Teaspoon	12 x 3 dz	38.88 lb
531094	127-016	Bouillon Spoon	12 x 3 dz	42.12 lb
531092	127-002	Dessert Spoon	12 x 3 dz	60.12 lb
531095	127-021	Iced Teaspoon	12 x 3 dz	38.00 lb
531139	127-030	Dinner Fork	12 x 3 dz	48.75 lb
531154	127-029	Cocktail Fork	12 x 3 dz	24.45 lb
531148	127-038	Salad Fork	12 x 3 dz	41.40 lb
531122	127-7922	Dinner Knife, Fl. Bl., S.H.	18 x 1 dz	37.05 lb

Sold in case pack or inner pack.

WORLD
TABLEWARE
A Libbey FOODSERVICE Company



WORLD
TABLEWARE
A Libbey FOODSERVICE Company

WELLINGTON

- Brandware® 18/0 Collection
- Extra heavy weight

Item #	Mfg. #	Description	Cs Pk	Cs Wt
489622	145-001	American Teaspoon	12 x 3 dz	51.00 lb
489623	145-016	Bouillon Spoon	12 x 3 dz	47.99 lb
489617	145-021	Iced Teaspoon	12 x 3 dz	46.00 lb
489619	145-030	Dinner Fork	12 x 3 dz	65.99 lb
489618	145-029	Cocktail Fork	12 x 3 dz	28.00 lb
489620	145-038	Salad Fork	12 x 3 dz	33.99 lb
489621	145-5262	Dinner Knife, Fl. Bl., S.H.	18 x 1 dz	32.00 lb

Sold in case pack or inner pack.



FREEDOM

- Brandware® 18/0 Collection
- Heavy weight
- Satin finished handles



Item #	Mfg. #	Description	Cs Pk	Cs Wt
531123	132-001	Teaspoon	24 x 3 dz	54.00 lb
531127	132-016	Bouillon Spoon	12 x 3 dz	29.75 lb
531125	132-002	Dessert Spoon	12 x 3 dz	49.25 lb
531129	132-021	Iced Teaspoon	12 x 3 dz	25.45 lb
531144	132-030	Dinner Fork, 3 Tine	12 x 3 dz	38.52 lb
531145	132-0304	Dinner Fork, 4 Tine	12 x 3 dz	38.99 lb
531135	132-029	Cocktail Fork	12 x 3 dz	19.35 lb
531158	132-038	Salad Fork, 3 Tine	12 x 3 dz	24.15 lb
531133	132-5262	Dinner Knife, Fl. Bl., S.H.	18 x 1 dz	33.30 lb

Sold in case pack or inner pack.

HARBOUR

- Brandware® 18/0 Collection
- Extra heavy weight



Item #	Mfg. #	Description	Cs Pk	Cs Wt
531161	130-001	Teaspoon	12 x 3 dz	32.76 lb
534438	130-016	Bouillon Spoon	12 x 3 dz	32.10 lb
531162	130-002	Dessert Spoon	12 x 3 dz	48.00 lb
531165	130-021	Iced Teaspoon	12 x 3 dz	42.75 lb
531164	130-003	Tablespoon	12 x 3 dz	24.80 lb
531140	130-030	Dinner Fork	12 x 3 dz	40.99 lb
531156	130-029	Cocktail Fork	12 x 3 dz	22.65 lb
531150	130-038	Salad Fork	12 x 3 dz	28.75 lb
531277	130-5262	Dinner Knife, Fl. Bl., S.H.	18 x 1 dz	36.75 lb

Sold in case pack or inner pack.



SALEM

- Brandware® 18/0 Collection
- Heavy weight
- Satin finished handles



Item #	Mfg. #	Description	Cs Pk	Cs Wt
531299	138-001	American Teaspoon	24 x 3 dz	52.56 lb
531286	138-016	Bouillon Spoon	12 x 3 dz	29.85 lb
531290	138-002	Dessert Spoon	12 x 3 dz	44.50 lb
531292	138-021	Iced Teaspoon	12 x 3 dz	39.15 lb
531142	138-030	Dinner Fork	12 x 3 dz	39.00 lb
531134	138-038	Salad Fork	12 x 3 dz	25.70 lb
534440	138-5262	Dinner Knife	18 x 1 dz	30.95 lb

Sold in case pack or inner pack.



CASCADE™

- Brandware® 18/0 Collection
- Extra heavy weight
- Design patented



Item #	Mfg. #	Description	Cs Pk	Cs Wt
531086	165-001	American Teaspoon	12 x 3 dz	31.19 lb
506520	165-016	Bouillon Spoon	12 x 3 dz	25.20 lb
502632	165-030	Dinner Fork	12 x 3 dz	30.24 lb
470474	165-5262	Dinner Knife, Fl. Bl., S.H.	18 x 1 dz	29.16 lb

Sold in case pack or inner pack.



RIVA™

- Brandware® 18/0 Collection
- Heavy weight

Item #	Mfg. #	Description	Cs Pk	Cs Wt
531294	148-001	American Teaspoon	12 x 3 dz	42.12 lb
534447	148-016	Bouillon Spoon	12 x 3 dz	24.84 lb
531160	148-030	Dinner Fork	12 x 3 dz	29.16 lb
531159	148-038	Salad Fork	12 x 3 dz	22.68 lb
531272	148-5262	Dinner Knife, Fl. Bl., S.H.	18 x 1 dz	28.98 lb

Sold in case pack or inner pack.



REFLECTIONS

- Brandware® 18/0 Collection
- Extra heavy weight

Item #	Mfg. #	Description	Cs Pk	Cs Wt
534442	129-001	Teaspoon	12 x 3 dz	36.30 lb
534450	129-030	Dinner Fork	12 x 3 dz	45.20 lb
534445	129-7922	Dinner Knife, 1 pc	18 x 1 dz	47.55 lb

Sold in case pack or inner pack.

WINDSOR™

- Brandware® 18/0 Collection
- Designed for high volume

Item #	Mfg. #	Description	Cs Pk	Cs Wt
WINDSOR – ECONOMY MEDIUM WEIGHT				
526749	651-001	American Teaspoon	24 x 3 dz	37.44 lb
528038	651-016	Bouillon Spoon	12 x 3 dz	23.40 lb
528036	651-002	Dessert Spoon	12 x 3 dz	27.60 lb
528037	651-007	Demitasse Spoon	12 x 3 dz	14.60 lb
534431	651-003	Tablespoon	12 x 1 dz	14.16 lb
528040	651-030	Dinner Fork	12 x 3 dz	21.96 lb
528039	651-029	Cocktail Fork	12 x 3 dz	13.32 lb
534432	651-038	Salad Fork	12 x 3 dz	20.16 lb
535406	651-5302	Dinner Knife, Fl. Bl.	18 x 1 dz	20.52 lb

Item #	Mfg. #	Description	Cs Pk	Cs Wt
WINDSOR – HEAVY WEIGHT				
464430	141-001	American Teaspoon	24 x 3 dz	46.45 lb
464431	141-016	Bouillon Spoon	12 x 3 dz	26.75 lb
507694	141-021	Iced Teaspoon	12 x 3 dz	30.99 lb
464432	141-030	Dinner Fork	12 x 3 dz	30.00 lb
464433	141-5262	Dinner Knife, Fl. Bl.	18 x 1 dz	25.15 lb

Sold in case pack or inner pack.



DOMINION™

- Brandware® 18/0 Economy Collection
- Medium weight pattern designed for high volume, value conscious establishments

Item #	Mfg. #	Description	Cs Pk	Cs Wt
528050	657-001	American Teaspoon	24 x 3 dz	38.16 lb
528052	657-016	Bouillon Spoon	12 x 3 dz	22.68 lb
528051	657-002	Dessert Spoon	12 x 3 dz	27.65 lb
528053	657-021	Iced Teaspoon	12 x 3 dz	25.20 lb
528055	657-030	Dinner Fork	12 x 3 dz	21.96 lb
528054	657-029	Cocktail Fork	12 x 3 dz	12.99 lb
528056	657-038	Salad Fork	12 x 3 dz	20.05 lb
528057	657-5302	Dinner Knife, Fl. Bl.	18 x 1 dz	19.99 lb

Sold in case pack or inner pack.

 Cardinal



LATHAM

- The slender neck and curved handle of Latham offers an original and distinct look
- Paired with traditional dinnerware shapes, it makes for an attractive contrast
- 18/10 stainless steel • 10 year guarantee
- Cs Pk 1 x 1 dz

Item #	Mfg. #	Description	Cs Wt
531636	T3628	Teaspoon	0.75 lb
531634	T3606	Dessert Spoon	1.17 lb
531631	T3602	Dinner Spoon	1.87 lb
531625	T3601	Dinner Fork	1.52 lb
531638	T3629	Salad Fork	1.40 lb
531632	T3604	Dinner Knife	2.91 lb

Sold in case pack only.

PACIFIC RIM™

- Made of 18/10 stainless steel§
- Mirror finish



Item #	Mfg. #	Description	Cs Pk	Cs Wt
437454	PAC01	Teaspoon	20 x 3 dz	62.00 lb
437458	PAC12	Bouillon Spoon	25 x 2 dz	55.00 lb
437456	PAC07	Dessert Spoon	12 x 2 dz	42.00 lb
439790	PAC05	Dinner Fork	12 x 2 dz	35.04 lb
437675	PAC051	European Fork	12 x 2 dz	38.04 lb
437455	PAC06	Salad Fork	25 x 2 dz	49.00 lb
437457	PAC11	Butter Knife, S.H.	25 x 1 dz	37.00 lb
437460	PAC45	Dinner Knife, 1 pc	25 x 1 dz	65.00 lb
437461	PAC451	European Knife	25 x 1 dz	66.00 lb

Sold in case pack or inner pack.

§ *Except knives which are type 420 stainless steel.*

MONTEREY™

- Made of 18% chrome stainless steel*
- Traditional style

Item #	Mfg. #	Description	Cs Pk	Cs Wt
437436	2901	Teaspoon	20 x 3 dz	44.00 lb
437440	2907	Dessert Spoon	25 x 2 dz	53.00 lb
437438	2905	Dinner Fork	25 x 2 dz	44.00 lb
437453	2945	Dinner Knife, 1 pc	30 x 1 dz	60.00 lb

Sold in case pack or inner pack.

* *Except knives which are type 420 stainless steel.*



POISE™

- Made of 18% chrome stainless steel
- Medium weight



Item #	Mfg. #	Description	Cs Pk	Cs Wt
437462	5501	Teaspoon	20 x 3 dz	42.00 lb
437466	5512	Bouillon Spoon	25 x 2 dz	38.00 lb
437465	5507	Dessert Spoon	25 x 2 dz	44.00 lb
437463	5505	Dinner Fork	25 x 2 dz	44.00 lb
437469	5545	Dinner Knife, 1 pc	30 x 1 dz	60.90 lb

Sold in case pack or inner pack.



 **WALCO**

GODDESS™

- 18/10 stainless – shines like silver
- Heavy weight for durability
- Asymmetrical flowing lines add a delicate touch

Item #	Mfg. #	Description	Cs Pk	Cs Wt
536057	802101	Teaspoon	20 x 3 dz	57.00 lb
536065	802105	Dinner Fork	12 x 2 dz	29.00 lb
536072	802115	Cocktail Fork	25 x 2 dz	32.00 lb
536067	802106	Salad Fork	25 x 2 dz	43.00 lb
536073	802145	Dinner Knife, 1 pc	25 x 1 dz	46.00 lb

Sold in case pack or inner pack.

BOSA NOVA™

- 18/0 stainless steel with a brite finish
- Attractive pattern at an affordable price

Item #	Mfg. #	Description	Cs Pk	Cs Wt
536045	801801	Teaspoon	12 x 3 dz	31.00 lb
536047	801805	Dinner Fork	12 x 3 dz	48.00 lb
536054	801815	Cocktail Fork	12 x 3 dz	27.00 lb
536049	801806	Salad Fork	12 x 3 dz	42.00 lb
536056	801845	Dinner Knife, 1 pc	6 x 3 dz	60.25 lb

Sold in case pack or inner pack.

 **WALCO**



 **WALCO**

SAVILLE™

- Made of 18% chrome stainless steel

Item #	Mfg. #	Description	Cs Pk	Cs Wt
437696	6601	Teaspoon	20 x 3 dz	73.00 lb
437708	6612	Bouillon Spoon	25 x 2 dz	66.00 lb
437698	6605	Dinner Fork	12 x 2 dz	35.00 lb
437699	66051	European Fork	12 x 2 dz	44.00 lb
437710	6645	Dinner Knife, 1 pc	25 x 1 dz	64.00 lb

Sold in case pack or inner pack.

FANFARE™

- Made of 18% chrome stainless steel

Item #	Mfg. #	Description	Cs Pk	Cs Wt
437427	2801	Teaspoon	20 x 3 dz	55.00 lb
437433	2812	Bouillon Spoon	25 x 2 dz	52.00 lb
437429	2805	Dinner Fork	25 x 2 dz	68.00 lb
437435	2845	Dinner Knife, 1 pc	25 x 1 dz	72.00 lb

Sold in case pack or inner pack.

 **WALCO**



ROYAL BRISTOL™

- Made of 18% chrome stainless steel
- Medium weight

Item #	Mfg. #	Description	Cs Pk	Cs Wt
437470	5101	Teaspoon	20 x 3 dz	44.00 lb
437476	5112	Bouillon Spoon	25 x 2 dz	36.00 lb
437473	5105	Dinner Fork, 3-Tine	25 x 2 dz	51.00 lb
437474	51054	Dinner Fork, 4-Tine	25 x 2 dz	55.00 lb
437475	5106	Salad Fork	25 x 2 dz	33.00 lb
437477	5145	Dinner Knife, 1 pc	30 x 1 dz	63.00 lb

Sold in case pack or inner pack.



BARCLAY™

- Made of 18% chrome stainless steel

Item #	Mfg. #	Description	Cs Pk	Cs Wt
437419	1101	Teaspoon	20 x 3 dz	42.00 lb
437424	1112	Bouillon Spoon	25 x 2 dz	37.00 lb
437423	1107	Dessert Spoon	25 x 2 dz	52.00 lb
437421	1105	Dinner Fork	25 x 2 dz	37.00 lb
437426	1145	Dinner Knife, 1 pc	30 x 1 dz	54.00 lb

Sold in case pack or inner pack.

WINDSOR™

- Made of 18% chrome stainless steel
- Medium weight

Item #	Mfg. #	Description	Cs Pk	Cs Wt
MEDIUM WEIGHT				
437543	7201	Teaspoon	20 x 3 dz	34.00 lb
437544	7212	Bouillon Spoon	25 x 2 dz	31.00 lb
437545	7207	Dessert Spoon	25 x 2 dz	39.00 lb
437546	7204	Iced Teaspoon	25 x 2 dz	36.00 lb
437547	7205	Dinner Fork	25 x 2 dz	35.00 lb
437552	7206	Salad Fork	25 x 2 dz	28.00 lb
437553	7224	Dinner Knife, 1 pc, Serrated	30 x 1 dz	37.00 lb

Sold in case pack or inner pack.



DOMINION™

- Made of 18% chrome stainless steel
- Medium weight

Item #	Mfg. #	Description	Cs Pk	Cs Wt
437554	7401	Teaspoon	20 x 3 dz	34.00 lb
437555	7412	Bouillon Spoon	25 x 2 dz	31.00 lb
437556	7407	Dessert Spoon	25 x 2 dz	39.00 lb
437570	7404	Iced Teaspoon	25 x 2 dz	36.00 lb
437571	7405	Dinner Fork	25 x 2 dz	35.00 lb
437572	7406	Salad Fork	25 x 2 dz	28.00 lb
437573	7443	Dinner Knife, 1 pc, Serrated	30 x 1 dz	37.00 lb

Sold in case pack or inner pack.



SHELLEY

- Mirror finished 18% chrome
- Extra heavy weight



CLEAR PACK - CASH & CARRY

Item #	Mfg. #	Description	Cs Pk	Cs Wt
476417	SH/CP-501	Teaspoon	36 x 1 dz	42.90 lb
476418	SH/CP-502	Bouillon Spoon	36 x 1 dz	41.80 lb
476419	SH/CP-503	Dessert Spoon	36 x 1 dz	53.90 lb
476421	SH/CP-505	Dinner Fork	36 x 1 dz	47.30 lb
476423	SH/CP-507	Oyster/Cocktail Fork	36 x 1 dz	24.20 lb
476424	SH/CP-508	Dinner Knife	18 x 1 dz	37.40 lb

Sold in case pack or inner pack.

REGENCY

- Mirror polished 18/10 stainless steel
- Extra heavy weight

Item #	Mfg. #	Description	Cs Pk	Cs Wt
495829	RE-101	Teaspoon	24 x 1 dz	25.00 lb
497115	RE-103	Dessert Spoon	24 x 1 dz	39.00 lb
501030	RE-104	Iced Teaspoon	24 x 1 dz	33.00 lb
495830	RE-105	Dinner Fork	24 x 1 dz	38.00 lb
501129	RE-107	Oyster/Cocktail Fork	24 x 1 dz	26.00 lb
495831	RE-108	Dinner Knife	24 x 1 dz	67.00 lb
501130	RE-111	Table Fork, European Size	24 x 1 dz	50.00 lb
501131	RE-112	Table Knife, European Size	24 x 1 dz	76.00 lb

Sold in case pack or inner pack.



WINDSOR

- Brightly polished 18% chrome
- Medium weight

CLEAR PACK - CASH & CARRY

Item #	Mfg. #	Description	Cs Pk	Cs Wt
476436	WM/CP-31	Teaspoon	18 x 2 dz	18.00 lb
476437	WM/CP-32	Bouillon Spoon	18 x 2 dz	21.00 lb
476439	WM/CP-34	Iced Teaspoon	18 x 2 dz	27.00 lb
476442	WM/CP-35	Dinner Fork	18 x 2 dz	23.00 lb
476443	WM/CP-36	Salad Fork	18 x 2 dz	19.00 lb
476444	WM/CP-38	Dinner Knife, 1 pc	36 x 1 dz	19.00 lb

Sold in case pack or inner pack.

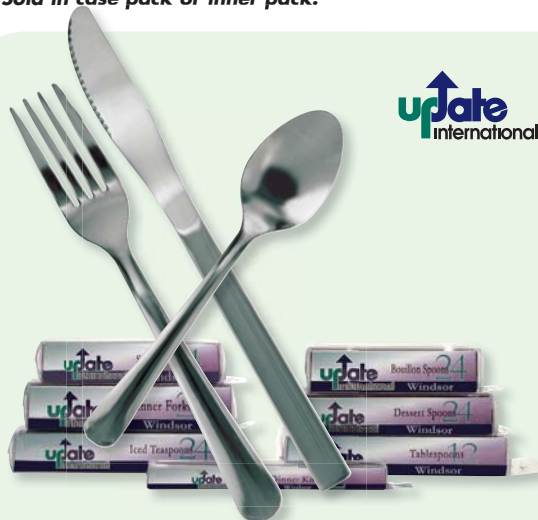

DOMINION

- Brightly polished 18% chrome
- Medium weight

CLEAR PACK - CASH & CARRY

Item #	Mfg. #	Description	Cs Pk	Cs Wt
476321	DOM/CP-11	Teaspoon	18 x 2 dz	21.00 lb
476323	DOM/CP-12	Bouillon Spoon	18 x 2 dz	22.00 lb
476335	DOM/CP-15	Dinner Fork	18 x 2 dz	26.00 lb
476337	DOM/CP-18	Dinner Knife, 1 pc	36 x 1 dz	48.00 lb

Sold in case pack or inner pack.





#B770KSHH



#B618KSSF



#B770KSSJ

DELCO ONEIDA®

ELITE STEAK KNIVES

- Stainless steel blade with molded handle

Item #	Mfg. #	Description	Length	Handle	Cs Pk	Cs Wt
389569	B770KSHH	Pioneer	9¾"	Hardwood	25 x 1 dz	48.00 lb
389567†	B618KSSF	Seville	8¾"	Polypropylene	50 x 1 dz	49.00 lb
389575	B770KSSJ	Doral	8"	Molded	50 x 1 dz	42.00 lb
389571†	B770KSSG	Laredo	10"	Polypropylene	25 x 1 dz	45.00 lb
389573	B770KSSK	Montana	9¾"	Red Polywood	25 x 1 dz	52.50 lb
389566	B617KSSF	Titan	8½"	Polypropylene	50 x 1 dz	65.00 lb
419846	B770KSSN	Longhorn	8½"	Nylon	25 x 1 dz	45.00 lb

Sold in case pack or inner pack. † Dishwasher Safe



#B770KSSG



#B770KSSK



#B617KSSF



#B770KSSN

DELCO ONEIDA®

ECONOLINE STEAK KNIVES

- Stainless steel blades

Item #	Mfg. #	Description	Length	Handle	Cs Pk	Cs Wt
389565	B615KSSF	316A	8½"	Bubinga Wood	24 x 3 dz	49.00 lb
389564	B614KSSF	305B	8"	Bubinga Wood	24 x 3 dz	40.00 lb
390374	B616KSSF	Sabre	8¼"	Bubinga Wood	1 x 3 dz	46.20 lb

Sold in case pack or inner pack.



#B615KSSF



#B614KSSF



#B616KSSF



#750527



#780527



#790527



#760527



#620527



#660527



#840529R

WALCO

ASSORTED STEAK KNIVES

Item #	Mfg. #	Description	Length	Handle	Cs Pk	Cs Wt
437497	750527	S/S Blade, Pointed Tip	4"	Hardwood	20 x 3 dz	34.00 lb
437500	780527	S/S Blade, Pointed Tip	4½"	Polypropylene	25 x 2 dz	47.00 lb
437501	790527	S/S Blade, Rounded Tip	4½"	Polypropylene	25 x 2 dz	43.00 lb
437498	760527	S/S Blade, Rounded Tip	3¾"	Hardwood	25 x 2 dz	41.00 lb
437502	840529R	Big Red™ Jumbo, S/S Blade, Pointed Tip	5"	Polywood	25 x 1 dz	66.00 lb
437492	620527	S/S Blade, Rounded Tip, Jumbo	5"	Polypropylene	25 x 1 dz	53.00 lb
437494	660527	UTICA™ Knife, Jumbo	5"	Lacquered Hardwood	25 x 1 dz	54.00 lb

Sold in case pack or inner pack.



#200-1492



#201-2632



#201-2642



#200-1692



#201-2492



#201-2702



#200-1702

STEAK KNIVES

- Dishwasher safe

Item #	Mfg. #	Description	Length	Handle	Cs Pk	Cs Wt
531274	200-1492	Beef Baron, Rounded Tip	10"	Rosewood	25 x 1 dz	55.00 lb
531276	201-2492	Beef Baron, Rounded Tip	10"	Black Polypropylene	25 x 1 dz	50.20 lb
531267	201-2632	Pointed Tip	9 1/4"	Black Bakelite	25 x 1 dz	43.00 lb
534700	201-2702	Rounded Tip	8 3/4"	Black Polypropylene	25 x 1 dz	24.00 lb
534699	201-2642	Rounded Tip	8 7/8"	Black Bakelite	25 x 1 dz	42.50 lb
534698	200-1692	Pointed Tip	8 1/2"	Pakka Wood	12 x 4 dz	40.85 lb
531282	200-1702	Rounded Tip	8 1/2"	Wood	25 x 2 dz	35.05 lb

Sold in case pack or inner pack.

WORLD
TABLEWARE
A Libbey FOODSERVICE Company



STEAK KNIVES

- Hollow ground blades
- Dishwasher safe

Item #	Mfg. #	Description	Cs Pk	Cs Wt
367991	48140	4 5/8", Pointed Tip, Hardwood Handle	1 x 2 dz	1.68 lb
395460	48143	4 3/4", Rounded Tip, Plastic Handle	1 x 2 dz	1.68 lb

Sold in case pack only.



#48140



#48143

FLATWARE CORROSION, TARNISHING & BUILDUPS

Corrosion in flatware occurs when chlorides in food soils dissolve and attack silverplating and stainless steel, permanently damaging their surfaces. Corrosion can result from several factors – the use of improper containers and compounds used for cleaning and storage, dirty presoak solutions, extra-long presoak times, and incorrect washing and drying procedures. Water and cleaning solutions can break down the flatware's protective oxide layer, and extended exposure to moisture increases the risk of rust.

Tableware should never remain soiled overnight. Presoaking is recommended, after which it should be immediately washed in high temperatures – low temperatures or chlorine baths will attack silver and metal. To prevent corrosion and film build-up, flatware must be rinsed thoroughly and dried immediately after rinsing.

To keep flatware looking new, a regular de-tarnishing and burnishing schedule must be established. In silverplated flatware, surface discolorations can be caused by silver sulfide deposits. In stainless steel, buildup of foreign material such as food soils or hard water deposits can cause a black, blue, or grey discoloration.

SUGGESTED FLATWARE SERVICE

	Rest/Hotel 100 People	Fine Dining 60-80 People	Pizza Restaurant 75 People	Deli 75 People	Buffet 200 People	Cafeteria 200 People
Teaspoons	30 dz	30 dz	12 dz	12 dz	40 dz	65 dz
Bouillon Spoons	15 dz	15 dz	8 dz	8 dz	34 dz	34 dz
Soup/Dessert Spoons	15 dz	15 dz	–	–	40 dz	40 dz
Tablespoons	2 dz	–	–	–	–	–
Iced Tea Spoon	15 dz	15 dz	15 dz	12 dz	21 dz	21 dz
Dinner Fork	30 dz	30 dz	12 dz	12 dz	60 dz	100 dz
Salad Fork	15 dz	15 dz	12 dz	12 dz	–	–
Cocktail Fork	12 dz	8 dz	–	–	–	–
Dinner Knife	20 dz	30 dz	8 dz	8 dz	40 dz	40 dz
Knife, Butter Spreaders	15 dz	12 dz	–	–	–	–
Steak Knives	†	†	†	†	10 dz	5 dz

†Quantity depends on type of service and menu

MAXIMILLIAN STEEL™ CHAFERS

- Mirror finished stainless steel
- Contemporary elegance at an affordable price
- All welded construction for added strength
- Full-size dome cover can be conveniently stored inside cover holder

Item #	Mfg. #	Description	Cs Pk	Cs Wt
431497	49520	9 quart Rectangular Full-Size	1 x 1 ea	18.40 lb
453137	49529	4.1 quart Rectangular Half-Size	1 x 1 ea	10.94 lb
480714	49522	6 quart Large Round	1 x 1 ea	11.78 lb



ODYSSEY® CHAFER

- 9 quart mirror finished stainless steel
- 24K gold-plated legs and handles
- All welded construction for added strength
- Full-size dome cover can be conveniently stored inside cover holder
- Includes integrated dome cover holder

Item #428885
Mfg. #46320
Cs Pk 1 x 1 ea
Cs Wt 17.50 lb



CLASSIC BRASS TRIM CHAFER

- 9 quart full-size oblong
- Solid cast brass leg and handles
- Mirror-finished 18/8 stainless steel
- Clear coated brass trim to deter discoloration
- Chafers include food pan, water pan, dome cover and fuel holders
- Made in USA

Item #428894
Mfg. #46050
Cs Pk 1 x 1 ea
Cs Wt 17.70 lb



DAKOTA™ CHAFER

- 9 quart rectangular
- Stainless steel matte-finished embossed legs
- Molded high temp Kool-Touch® nylon side handles for safe & easy transport
- Unit complete with Super Pan 3® full size food pan, water pan, dome cover, stacking frame and 2 fuel holders

Item #444237
Mfg. #99860
Cs Pk 1 x 1 ea
Cs Wt 15.80 lb



TRIMLINE II CHAFER

- 9 quart
- Welded frame is stackable for compact storage
- Fuel holders can be removed with water pan in place
- Includes 2½" d full-size Super Pan 3® food pan, dripless water pan, dome cover with Kool Touch® handle and two fuel holders
- Made in USA

Item #367932
Mfg. #99850
Cs Pk 1 x 1 ea
Cs Wt 13.94 lb





ECONOMY CHAFER

- 8 quart oblong
- Mirror finished stainless steel with welded frame and "stay cool" plastic handles
- Chafers complete with food pan, water pan, fuel holders, built-in lid holder and optional stainless steel handle

Item #457537
Mfg. #ES-1000
Cs Pk 1 x 1 ea
Cs Wt 13.00 lb

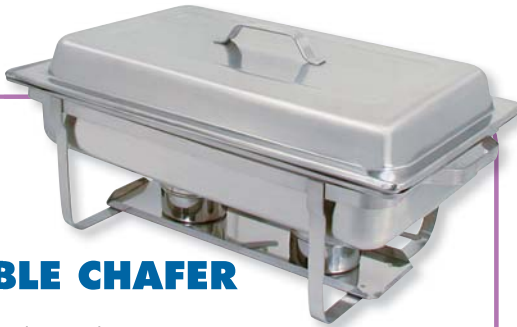

STACKABLE CHAFER

- 8 quart oblong
- Satin finished stainless steel
- Built-in lid holder
- Includes water pan, fuel holders, dome cover & stand

Item #481408
Mfg. #SCC-19
Cs Pk 1 x 1 ea
Cs Wt 15.00 lb



DALLAS CHAFER

- 8 quart heavyweight w/lift-off cover
- Stainless steel
- Includes food pan, dripless water pan, durable rack, and 2 fuel holders

Item #504990
Mfg. #C-6080
Cs Pk 1 x 1 ea
Cs Wt 25.00 lb

THE NEWBURG CHAFING DISH

- 8 quart oblong
- Stainless steel
- Includes both metal and plastic handles
- Mirror finished cover conveniently clips on to frame
- Individual color box

Item #504988
Mfg. #C-3080B
Cs Pk 1 x 1 ea
Cs Wt 13.60 lb



UNIVERSAL CHAFER HEATER

- Designed to maintain the proper serving temperature without the need for open flame
- Fits standard fuel cup openings
- Spring-loaded element maintains full contact with the water pan for efficiency
- Lighted switch glows when heater is turned on
- Two power settings (160W-Low/275W-Hi)
- Six foot long grounded cord
- Only one heater needed per full size chafers
- 120V • Made in USA

Item #432000
Mfg. #46060
Cs Pk 1 x 1 ea
Cs Wt 4.14 lb



FUEL HOLDER WITH COVER

- 18/8 stainless steel
- Fits all chafers stands



Item #381759
Mfg. #46864
Cs Pk 12 x 1 ea
Cs Wt 4.12 lb

Setting the Standard™



Sold in case pack or eaches.

WIRE CHAFER STAND

- Chrome plated
- Collapsible

Item #476435
Mfg. #WCS-KD
Cs Pk 10 x 1 ea
Cs Wt 17.50 lb

Sold in case pack or eaches.

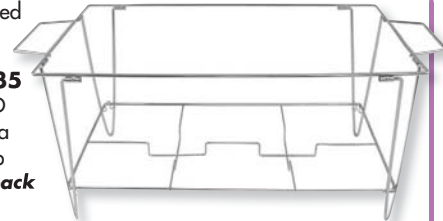

FUEL HOLDER

Item #482294
Mfg. #CC-FH
Cs Pk 12 x 1 ea
Cs Wt 4.25 lb

Sold in case pack or eaches.



POP-UP CHAFER SET

- Contains everything you need in one box: 1 heavy-duty metal pan holder, 1 reusable aluminum water pan, 2 aluminum food half pans, 1 plastic serving spoon & fork set, 2 cans of Sterno® 2 hour gel chafing fuel
- Fold-down frame for easy, space-saving storage
- Durable construction to store, set up and serve over and over again
- Utilizes standard aluminum foil food pans

Item #514407
Mfg. #ST07000
Cs Pk 1 x 4 ea
Cs Wt 15.00 lb

Sold in case pack only.





CHAFING FUEL

STOP Not Available via FedEx®.

Item #	Mfg. #	Description	Cs Pk	Cs Wt
Sterno® Brand Wick Chafing Fuel				
367959	ST05006	2 hr Stem Wick	1 x 24 ea	6.80 lb
367921	ST05010	4 hr Twist Cap Wick	1 x 24 ea	12.60 lb
367902	ST03009	6 hr Stem Wick	1 x 24 ea	16.10 lb
406939	ST05008	6 hr Stem Wick	6 x 4 ea	15.50 lb
458303	ST05009	6 hr Stem Wick	1 x 12 ea	7.40 lb
Sterno® Brand Hot Spot® SuperWick® Chafing Fuel				
367905	ST05016	4 hr	1 x 24 ea	18.10 lb
487134	ST05017	4 hr, Resealable Lid	1 x 24 ea	18.90 lb
Sterno® Brand Gel Chafing Fuel				
367942	ST04006G	45 min Gel	1 x 144 ea	28.00 lb
458302	ST04043	2 hr Gel	1 x 12 ea	8.30 lb
367901	ST04008G	2 hr Gel	1 x 72 ea	39.30 lb
367972	ST04028	1 Gallon Gel Refill	1 x 4 ea	31.40 lb
Handy Wick® Brand Chafing Fuel				
409315	HW03002	2 hr Twist Cap Wick	1 x 24 ea	7.20 lb
409316	HW03004	4 hr Twist Cap Wick	1 x 24 ea	12.80 lb
409317	HW03006	6 hr Twist Cap Wick	1 x 24 ea	18.00 lb
Handy Fuel® Brand Gel Chafing Fuel				
368007	HF03003	45 min Gel	1 x 144 ea	32.80 lb
367903	HF03008	2 hr Gel	1 x 72 ea	39.10 lb
378937	HF03007	1 Gallon Gel Refill	1 x 4 ea	31.00 lb
367910	HF03108	2 hr Gel, Pennsylvania Formula	1 x 72 ea	39.10 lb

Sold in case pack only.

STOP Not Available via FedEx®.

BLAZE
Trusted by top chefs

CHAFING FUEL

- Both jelled and liquid formulations are guaranteed
- Provides optimum flame and heat spread
- Increased burn time and constant temperatures
- All fuels are sustainable and environmentally friendly
- ISO 9000 Certified, Kosher Approved



Item #	Mfg. #	Description	Cs Pk	Cs Wt
Jelled Ethanol Fuel				
181673	BB100	2 hr Burn Time	1 x 72 ea	35.80 lb
520604	BB400	45 min Burn Time	1 x 144 ea	29.00 lb
Jelled Methanol Fuel				
181666	GB100	2 hr Burn Time	1 x 72 ea	35.80 lb
181698	GB200	1 Gallon Refill	4 x 1 gal	32.10 lb
Liquid Diethylene Glycol Fuel				
398476	CW300	Clear Wick, 5½ hr Burn Time, Stackable	1 x 24 ea	15.90 lb
181709	LB300	Liquid Blaze, 5½ hr Burn Time, Twist Top	1 x 24 ea	14.20 lb
533487	LB700	Liquid Blaze, 4 hr Burn Time, Twist Top	1 x 24 ea	13.00 lb
345744	SB700	Liquid Blaze, 4 hr Burn Time, Screw Cap	1 x 24 ea	13.80 lb

Sold in case pack only.



STERNO® CULINARY JET PORTABLE BURNER w/STAND

- Great for buffet or tabletop cooking/warming
- Stainless steel body with heat-resistant handle
- Heavy-duty, tip-free base and cooking stand
- One-hand, instant start Piezo ignition with safety button

Item #530754

Mfg. #ST06005

Cs Pk 6 x 1 ea

Cs Wt 12.60 lb

Sold in case pack or eaches.



The **STERNO** GROUP



Fuel sold separately.

STERNO® BUTANE ACTIONSTATION™ STOVE

- 7000 BTU per hour output for high volume cooking
- Premium-quality, stainless steel with long, textured grates for stability
- Adjustable flame
- Piezo ignition with safety lock and automatic shut-off pressure sensor
- Durable plastic carrying case

Item #510060

Mfg. #ST06004

Cs Pk 6 x 1 ea

Cs Wt 30.00 lb

Sold in case pack or eaches.

The **STERNO** GROUP

STERNO® PROFESSIONAL CULINARY TORCH

- Anti-flare design
- Piezo ignition for instant start-up and adjustable flame
- Immediate shut-off function
- Safety switch
- 8 oz can burns 2-4 hours

Item #510062

Mfg. #ST06003

Cs Pk 10 x 1 ea

Cs Wt 0.60 lb

Sold in case pack or eaches.

Fuel sold separately.



The **STERNO** GROUP

BUTANE FUEL

- 8 oz
- Burns 2-4 hours

Item #444707

Mfg. #ST06000

Cs Pk 1 x 12 ea

Cs Wt 9.50 lb

Sold in case pack only.



PORTABLE BUTANE STOVE

- Solid brass burner
- High heat output of 10,000 BTU's
- Automatic Piezo electric ignition system
- Pressure sensor safety stop
- Adjustable heat range, from boil to simmer
- High impact protective carrying case

CHEF-MASTER

Item #479602

Mfg. #90004

Cs Pk 6 x 1 ea

Cs Wt 35.00 lb

Sold in case pack or eaches.



BUTANE GAS LIGHTER

- Refillable butane gas lighter with flame adjusting lever, safety lock and fuel level window
- 11" long

Item #397295

Mfg. #11005

Cs Pk 6 x 2 dz

Cs Wt 30.00

Sold in case pack or eaches.



CHEF'S TORCH

- 2012°F max temperature
- Automatic ignition
- Max 3 hr burn time per 8 oz canister

Item #476396

Mfg. #90014

Cs Pk 1 x 12 ea

Cs Wt 6.00 lb

Sold in case pack only.

Fuel sold separately.

CHEF-MASTER



BUTANE FUEL

- Factory sealed, non-refillable
- Valve automatically reseals when canister is removed from stove
- 8 oz • Burns 2-4 hours

Item #379272

Mfg. #40062

Cs Pk 1 x 1 dz

Cs Wt 11.00 lb

Sold in case pack only.



INDUCTION COOKER

- Stainless steel with ceramic top
- Push-button operation
- 140° to 464°F temperature range
- 12" w x 15½" l x 4¼" h
- 1800 watt, 120V

update international



Item #535459

Mfg. #IC-1800W

Cs Pk 4 x 1 ea

Cs Wt 53.00 lb

Sold in case pack only.



FLEXIGLOW® HEAT LAMP

- Spun aluminum shade with flared rim for added strength
- Perfect for catering or banquet halls, hotels and rental companies
- 39" flexible arm
- Includes 250 watt red bulb
- Drilled shade for increased heat dissipation
- Switch located away from the heat source
- Includes NSF listed maple cutting board (16" x 24") and drip pan (18" x 26")
- Cutting board and pan turn heat lamp into a front-of-the-house carving station
- Color: Aluminum

Item #380750
 Mfg. #HL8195B00
 Cs Pk 1 x 1 ea
 Cs Wt 27.65 lb

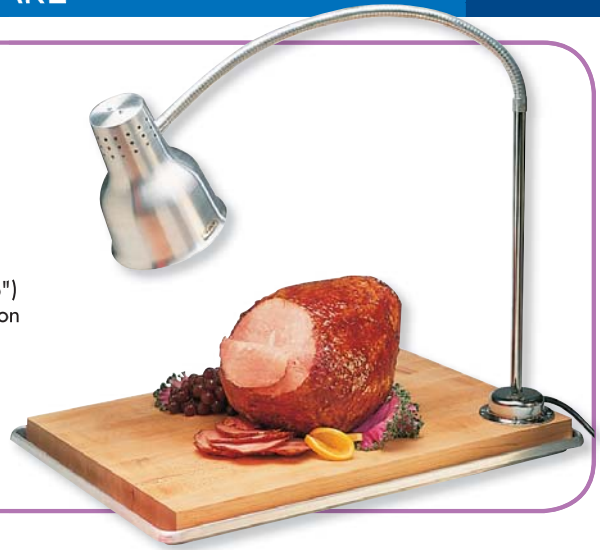

"Exceeding your expectations"



CARVING STATION

- Combines the heat of a 250 watt infrared bulb with a convenient, functional, USDA high density polyethylene cutting board
- Adjustable, 30" high, flexible gooseneck
- 120V

Item #423095
 Mfg. #6015
 Cs Pk 1 x 1 ea
 Cs Wt 21.00 lb



OVAL SERVING TRAYS

- 18/10 stainless steel
- Rolled edges for added strength
- Cs Pk 10 x 1 ea



Item #	Mfg. #	Description	Cs Wt
437756	O-U16	16 ⁵ / ₁₆ " x 11 ¹ / ₁₆ "	13.00 lb
437757	O-U18	18 ¹ / ₈ " x 13 ³ / ₁₆ "	12.33 lb

Sold in case pack or eaches.



HOLLOW HANDLE BUFFETWARE

- Elegantly crafted in one-piece mirror finished stainless steel
- Comfortable handle, well balanced design
- Cs Pk 12 x 1 ea

Item #	Mfg. #	Description	Cs Wt
A. 379672	46935	Pie Server, 11 ¹ / ₁₆ "	4.68 lb
B. 379673	46936	Pastry Server, 11"	3.72 lb
C. 379674	46952	Serving Spoon, Solid, 11 ¹ / ₁₆ "	3.51 lb
D. 379678	46960	Serving Spoon, Slotted, 12"	3.12 lb

Sold in case pack or eaches.



#74151



#74149

TABLETOP SERVING TONGS

- 18/10 mirror finished stainless steel
- Perfect tool for elegant buffet service
- Stylishly designed for durability and function
- Cs Pk 10 x 1 ea

Item #	Mfg. #	Description	Cs Wt
437746	74149	Pastry Tongs, 9"	3.67 lb
437748	74151	Salad Tongs, 10"	6.67 lb

Sold in case pack or eaches.

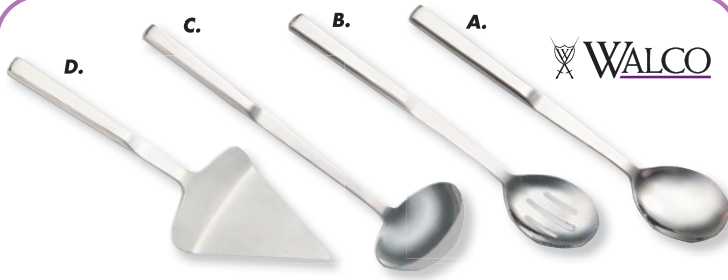

ROYAL DANISH™ BUFFETWARE

- 18/10 mirror finished stainless steel
- Molded handles for a comfortable grip
- Cs Pk 12 x 1 ea

Item #	Mfg. #	Description	Cs Wt
A. 437505	WLB01	Solid Serving Spoon, 12"	3.50 lb
B. 437506	WLB02	Slotted Serving Spoon, 12"	3.33 lb
C. 437507	WLB04	Deep Ladle, 12"	5.17 lb
D. 437729	WLB06	Pie Server, 12"	4.33 lb

Sold in case pack or eaches.

QUEEN ANNE™ SERVING SPOON

- 18% chrome stainless steel
- Satin-finished, heavyweight
- 8 3/8" long

Item #368243
Mfg. #48104
Cs Pk 1 x 1 dz
Cs Wt 1.56 lb

Sold in case pack only.



PASTRY/MEAT TONGS

- 8 1/4" long

Item #484774

Mfg. #PMT8
Cs Pk 12 x 1 ea

Cs Wt 3.00 lb
Sold in case pack or eaches.



BUFFETWARE

- One-piece stainless steel mirror polished finish
- Hollow handle
- Cs Pk 12 x 1 ea

Item #	Mfg. #	Description	Cs Wt
A. 476350	HB-1/PH	Solid Spoon, 11 3/4"	3.52 lb
B. 476351	HB-10/PH	Spout Ladle, 10 1/4", 2 oz	5.50 lb
C. 476356	HB-11/PH	Perforated Turner, 14 1/4"	4.84 lb
D. 476357	HB-2/PH	Slotted Spoon, 11 3/4"	3.30 lb
E. 476360	HB-5/PH	Pastry Server, 10 3/4"	3.90 lb
F. 476361	HB-7/PH	Cold Meat Fork, 10 1/4"	2.64 lb

Sold in case pack or eaches.

ULTRA™ BUFFETWARE

- 18/10 hotel weight mirror finished stainless steel
- Holds its shine
- Cs Pk 12 x 1 ea



Item #	Mfg. #	Description	Cs Wt
A. 437732	UL-011	Soup Ladle, 11 3/4"	4.50 lb
B. 437733	UL-012	Solid Serving Spoon, 10 1/2"	4.00 lb
C. 437734	UL-014	Meat Fork, 10 1/2"	2.75 lb
D. 437735	UL-015	Wide Bottom Spoon, 9 1/2"	2.75 lb
E. 437736	UL-125	Long Handle Spoon, 13 3/8"	4.50 lb
F. 437737	UL-126	Long Handle Slotted Spoon, 13 3/8"	4.50 lb
G. 437739	UL-022	Pastry Server, 9 1/2"	2.75 lb
H. 437740	UL-027	Cake/Pie Server, 10 1/4"	3.75 lb
I. 437742	UL-029	Punch Ladle, 13 3/8"	4.75 lb
J. 437743	UL-7223	Ice Tongs, 6"	1.75 lb
K. 437744	UL-7225	Small Tongs, 6"	2.25 lb
L. 437745	UL-7253	Serving Tongs, 8 1/4"	3.75 lb

Sold in case pack or eaches.



PETAL MIST® BOWLS AND PLATES

- Made of tough, break-resistant polycarbonate
- Textured exterior hides scratches; easy-clean smooth interior
- Safe for use in freezers and in temperatures from -40° up to 212°F
- Dishwasher safe
- Color: Clear

Item #	Mfg. #	Description	Cs Pk	Cs Wt
Buffet Bowls				
A. 380755	691707	9.7 qt, 15" dia	4 x 1 ea	8.05 lb
B. 380756	691907	17.2 qt, 18" dia	4 x 1 ea	13.00 lb
<i>Sold by case pack or eaches.</i>				
C. 428270	693107	3.4 qt Bell Shape, 9¾" dia	1 x 4 ea	4.10 lb
Plates				
D. 396790	690707	23.9 oz Soup/Salad, 8" dia	1 x 3 dz	12.65 lb
E. 397762	695407	7½" dia	1 x 3 dz	10.35 lb
<i>Sold in case pack only.</i>				



PETAL MIST® TRAY

- Use for sandwiches, meats, pastries, desserts, and bakery items
- Perfect for buffets or displaying catered foods
- Safe for use in freezers and in temperatures from -40° up to 212°F
- Dishwasher safe
- Rectangular, 16" x 22"
- Color: Clear



Item #380754
Mfg. #694707
Cs Pk 6 x 1 ea
Cs Wt 15.80 lb
Sold in case pack or eaches.

PEDESTAL PUNCH BOWL

- Break-resistant acrylic
- Tolerates temperatures from 32° to 160°F
- Pebbled exterior hides scratches
- 26 qt capacity
- 17½" dia
- Color: Clear

Item #380757
Mfg. #SP1807
Cs Pk 1 x 1 ea
Cs Wt 5.60 lb



LADLE

- Ideal for salads, punch, fruit, etc.
- Dishwasher safe, clear polycarbonate

Item #397060
Mfg. #500LC
Cs Pk 12 x 1 ea
Cs Wt 3.00 lb



Swan



Dolphin



Bride and Groom



Basket

ICE SCULPTURES™

- Quick and easy way to turn any table into a showpiece
- Fill mold with water, freeze, and cut open the mold
- Features patented EZ-Cut Bead™ opening system – makes it quick and easy to “un-mold” a work of art
- Contracting Cone Base™ allows for expansion while freezing to eliminate the major cause of cracking and breaking in the molding process
- One time use
- Color: White
- Instructions included with every mold
- Cs Pk 1 x 1 ea

Item #	Mfg. #	Description	Cs Wt
380743	SSW102	Swan	5.90 lb
380744	SDO102	Dolphin	9.00 lb
380742	SBG102	Bride and Groom	6.03 lb
370927	SBA102	Basket	9.00 lb



DISPLAY COVER

- Use for merchandising fresh fruits, desserts, salads, sandwiches or bakery items
- Covers enhance and protect the look and taste of your food items – helps keep food fresh and sanitary
- Stainless steel hinges & screws
- Hinged clear acrylic with polished chrome handles
- 26" w x 18" d



Item #380762
Mfg. #SC2607
Cs Pk 1 x 1 ea
Cs Wt 6.85 lb

Food trays sold separately.

CAMWEAR® DISPLAY COVER

- Made of virtually unbreakable polycarbonate
- Hinged with chrome handles
- 20" w x 12" d x 4 5/8" h



Item #377360
Mfg. #RD1220CWH-135
Cs Pk 1 x 1 ea
Cs Wt 4.14 lb

Food tray sold separately.

PASTRY DISPLAY CASES

- Acrylic
- Self-serve front door
- Easy magnetic closing door

- Four trays
- 14" w x 24" d x 24" h

Item #477338
Mfg. #APB-1424FD
Cs Pk 1 x 1 ea
Cs Wt 40.00 lb



- Two trays
- 21" w x 17 1/4" d x 12" h

Item #482271
Mfg. #APB-2112FD
Cs Pk 1 x 1 ea
Cs Wt 20.00 lb

- Three trays
- 21" w x 17 1/4" d x 16 1/2" h

Item #477339
Mfg. #APB-2117
Cs Pk 1 x 1 ea
Cs Wt 28.00 lb



POLYCARBONATE DISPLAY COVER

- Attractive dome cover keeps food fresh
- End cut-out provides easy access and promotes impulse purchases
- Color: Clear with polished chrome handle
- 12" x 20"

Item #457298
Mfg. #PSD21EH07
Cs Pk 1 x 1 ea
Cs Wt 3.70 lb



Food tray sold separately.



CAKE COVER

- Clear covers display desserts and pastries at their best
- Helps keep foods fresher longer
- Clear SAN with polished chrome handle
- 12" dia x 6 1/2" h



Food tray sold separately.

Item #380768
Mfg. #251207
Cs Pk 6 x 1 ea
Cs Wt 9.95 lb
Sold in case pack or eaches.

CAKE STAND

- Stainless steel assembled stand
- 12 3/4" dia x 6 3/4" h



Item #394997
Mfg. #821
Cs Pk 1 x 1 ea
Cs Wt 3.00 lb

Optional cover sold separately.



DELI CROCKS & COVERS

- Prep, store and serve all in one
- Ideal for supermarket delis, buffets and catered events
- Made of SAN for an economical option that offers impact, stain, break and chip resistance
- Handled covers are made of clear Camwear® polycarbonate



CAMBRO
TRUSTED FOR GENERATIONS™

Item #	Mfg. #	Description	Cs Pk	Cs Wt
Crocks				
423603	DC5-404	2.2 qt, Red	6 x 1 ea	3.93 lb
423311	DC5-110	2.2 qt, Black	6 x 1 ea	3.93 lb
423313	DC10-404	4.9 qt, Red	6 x 1 ea	6.87 lb
423604	DC10-110	4.9 qt, Black	6 x 1 ea	6.87 lb
Handled Covers – Clear				
423420	DCC5-135	Fits DC5	6 x 1 ea	2.65 lb
423425	DCC10-135	Fits DC10	6 x 1 ea	4.97 lb

Sold in case pack or eaches.

CLASSIC™ CROCKS & LIDS

- Thick walled heavyweight design made of high quality SAN
- Excellent chemical resistance to food acids, dressings
- High gloss finish is extremely scuff resistant
- 0° to 180°F temperature range
- Translucent snap on lids included
- Dishwasher safe

CARLISLE
FoodService Products



Item #	Mfg. #	Description	Cs Pk	Cs Wt
Crocks				
397521	030106	1.2 qt, Beige	12 x 1 ea	7.30 lb
397519	030101	1.2 qt, Reddish Brown	12 x 1 ea	7.30 lb
397257	031606	1.5 qt, Beige	6 x 1 ea	6.00 lb
397523	030206	2.7 qt, Beige	6 x 1 ea	7.10 lb
397522	030201	2.7 qt, Reddish Brown	6 x 1 ea	7.10 lb
Lids – Translucent				
473606	031130	Fits 1.2 qt	12 x 1 ea	.60 lb
397501	020230	Fits 1.5/2.7 qt	12 x 1 ea	1.26 lb

Sold in case pack or eaches.

POLY-TUF™ CROCKS & LIDS

- Economical, resilient polypropylene
- Glossy finish resists chipping and cracking
- 32° to 180°F temp. range
- Translucent snap on lids included
- Dishwasher safe

CARLISLE
FoodService Products



Item #	Mfg. #	Description	Cs Pk	Cs Wt
Crocks				
380630	034106	1.2 qt w/Lid, Beige	12 x 1 ea	6.20 lb
380629	034103	1.2 qt w/Lid, Black	12 x 1 ea	6.20 lb
380631	034101	1.2 qt w/Lid, Reddish-Brown	12 x 1 ea	6.20 lb
380633	034306	1.5 qt w/Lid, Beige	6 x 1 ea	4.05 lb
380632	034303	1.5 qt w/Lid, Black	6 x 1 ea	4.05 lb
380634	034301	1.5 qt w/Lid, Reddish-Brown	6 x 1 ea	4.05 lb
380636	034206	2.7 qt w/Lid, Beige	6 x 1 ea	5.40 lb
380635	034203	2.7 qt w/Lid, Black	6 x 1 ea	5.40 lb
380637	034201	2.7 qt w/Lid, Reddish-Brown	6 x 1 ea	5.40 lb
Lids – Translucent				
473606	031130	Fits 1.2 qt Crocks	12 x 1 ea	0.60 lb
397501	020230	Fits 1.5/2.7 qt Crocks	12 x 1 ea	1.26 lb

Sold in case pack or eaches.



NSF

CAMBRO
TRUSTED FOR GENERATIONS™

COLDFEST® FOOD PANS & CROCK

- Keep foods chilled at or below HACCP guidelines of 41°F (4°C)
- The half-size and third-size food pans hold temps up to 8 hours
- The sixth-size and round crock will hold temps up to 6 hours
- High impact resistant ABS material and FDA approved non-toxic gel
- Dishwasher safe • Stackable

Item #	Mfg. #	Description	Cs Wt
Pans – Cs Pk 1 x 1 ea			
458967	26CF-110	Half Size, 6.5 qt, Black	7.23 lb
431296	26CF-148	Half Size, 6.5 qt, White	7.23 lb
431350	36CF-148	Third Size, 3.7 qt, White	4.86 lb
431351	66CF-148	Sixth Size, 1.5 qt, White	2.67 lb
431353	CFR18-148	Round Crock, 1.7 qt, White	3.02 lb
Flat Covers – Clear – Cs Pk 1 x 2 ea			
432147†	CFRC18-135	Fits CFR18148	0.45 lb
432143	20CFC-135	Fits 26CF148	1.50 lb
432146	30CFC-135	Fits 36CF148	1.03 lb
432025	60CFC-135	Fits 66CF148	0.45 lb

Sold in case pack only. † Not NSF

SOLID CROCKS WITH LIDS

- The ideal dressing or condiment containers for your salad bar
- Smooth, easy to clean interior and exterior
- Made of FDA accepted material unaffected by salad oils or mayonnaise
- Snap tight white lids for convenient storage

CAMBRO
TRUSTED FOR GENERATIONS™

Stocked in beige only.



NSF

Item #	Mfg. #	Description	Cs Pk	Cs Wt
381675	CP12-133	1.2 qt, Beige	12 x 1 ea	6.58 lb
381674	CP27-133	2.7 qt, Beige	6 x 1 ea	5.58 lb

Sold in case pack or eaches.

ROUND BEEHIVE BOWLS

- Double wall construction maintains proper food temperature
- Great for cold or hot food
- Heavy-gauge stainless steel, mirror finished exterior, satin finished interior for an upscale look
- Dishwasher safe



#46590



#46569



Item #	Mfg. #	Description	Cs Pk	Cs Wt
446063	46590	7 1/4" dia, 1.7 qt	6 x 1 ea	9.70 lb
458968	46569	13 3/4" dia, 10.1 qt	2 x 1 ea	10.90 lb

Sold in case pack or eaches.

WOOD BOWLS

- 4-ply standard weight with round bottom
- Hand wash only
- Color: Mahogany



Item #	Mfg. #	Description	Cs Pk	Cs Wt
397378	205	5 1/2" dia	1 x 1 dz	1.25 lb
380214	206	6" dia	1 x 1 dz	1.50 lb
380215	208	8" dia	1 x 1 dz	2.67 lb
380216	210	10" dia	1 x 1 dz	4.50 lb
380217	212	12" dia	1 x 1 dz	7.50 lb

Sold in case pack only.



#PSB23-176



#PSB18-176

#PSB15-176



#PSB12-176

#PSB10-176



#PSB8-176



#PSB6-176

CAMWEAR® PEBBLED BOWLS

- Made of virtually unbreakable Camwear polycarbonate
- Smooth interior, pebbled exterior
- Color: Clear

Item #	Mfg.#	Description	Cs Pk	Cs Wt
368301 ^	PSB6-176	6" dia, 18.8 oz	1 x 1 dz	2.32 lb
393065	PSB8-176	8" dia, 1.8 qt	12 x 1 ea	4.43 lb
468202	PSB10-176	10" dia, 3.2 qt	12 x 1 ea	9.00 lb
393069	PSB12-176	12" dia, 5.8 qt	12 x 1 ea	12.37 lb
468244	PSB15-176	15" dia, 11.2 qt	4 x 1 ea	5.88 lb
393070	PSB18-176	18" dia, 20.2 qt	4 x 1 ea	12.54 lb
468264	PSB23-176	23" dia, 40.0 qt	4 x 1 ea	19.33 lb

Sold in case pack or eaches. ^Sold in case pack only.

SALAD BOWLS

- Made of impact-resistant melamine
- Color: Black (smooth) or maple (wood tone) finish



#500

#575



Item #	Mfg. #	Description	Cs Pk	Cs Wt
380641	500B03	10 oz, 5 1/2" dia, Black	6 x 1 dz	11.00 lb
380640	500M20	10 oz, 5 1/2" dia, Maple	6 x 1 dz	11.00 lb
380643	575B03	13 oz, 6" dia, Black	6 x 1 dz	10.40 lb
380642	575M20	13 oz, 6" dia, Maple	6 x 1 dz	10.40 lb
380644	800B03	27 oz, 7 1/2" dia, Black	4 x 1 dz	19.80 lb

Sold in case pack or inner pack.

CAMWEAR® RECTANGULAR RIBBED BOWLS

- Stylish, contemporary look for a dramatic presentation
- Made of Camwear polycarbonate; will not break or chip like acrylic
- Color: Black
- Cs Pk 4 x 1 ea



#RSB1014CW-110



Item #	Mfg. #	Description	Cs Wt
467901	RSB1014CW-110	10 3/4" x 14 5/8", 5 qt	4.60 lb
468163	RSB1419CW-110	14 1/4" x 19 3/8", 12 qt	8.85 lb

Sold in case pack or eaches.

HIGH HEAT SERVING SPOON

- High heat polysulfone; withstands temperatures from -40° to 375°F without melting or transferring heat
- One-piece, break-resistant construction
- Spoon handle has notch so spoon can rest on food pan and hole at end for hanging
- 13" long, perforated
- Dishwasher safe
- Color: Black



Item #397294

Mfg. #442603
Cs Pk 12 x 1 ea
Cs Wt 1.70 lb

Sold in case pack or eaches.



CAMWEAR® LADLE

- ¾ oz, 8½" long
- Made of virtually unbreakable polycarbonate
- Handles are angled for easy access and controlled grip
- Fits crocks 1.2 & 1.5 qt
- Color: Clear

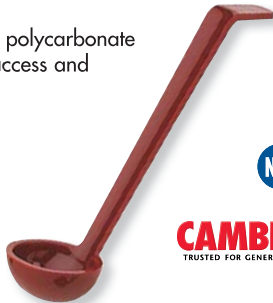

Item #388040

Mfg. #LD85-135
Cs Pk 12 x 1 ea
Cs Wt 1.00 lb

Sold in case pack or eaches.



Stocked in clear only.



CARLY® LADLES

- 9½" long
- One-piece polycarbonate construction
- Handle available plain or imprinted with dressing name: beige w/dark brown letters, black w/white letters
- One-ounce, oval-shaped bowl allows pouring of dressings from both sides
- Cs Pk 12 x 1 ea
- Cs Wt 0.96 lb



Item #	Mfg. #	Description
380663	029506	Plain, Beige
380662	029503	Plain, Black
380672	129506	Bleu Cheese, Beige
380670	129503	Bleu Cheese, Black
380665	229506	French, Beige
380664	229503	French, Black
380667	329506	House, Beige
380666	329503	House, Black
380674	429506	Italian, Beige
380673	429503	Italian, Black
380669	629506	Thousand Island, Beige
380668	629503	Thousand Island, Black
380677	829506	Low-Cal, Beige
380675	829503	Low-Cal, Black

Sold in case pack or eaches.

SALAD/BUFFET SPOONS

- Provides portion control for salad toppings
- One-piece, tough polycarbonate withstands temperatures up to 212°F; withstands dry heat up to 270°F
- Dishwasher safe
- Cs Pk 12 x 1 ea



Item #	Mfg. #	Color	Cs Wt
Solid, 8" long, ½ oz			
380658	446006	Beige	0.55 lb
380657	446003	Black	0.55 lb
Solid, 10" long, ¾ oz			
380660	447006	Beige	0.75 lb
380659	447003	Black	0.75 lb
Perforated, 10"l, ¾ oz (not shown)			
397796	447103	Black	0.70 lb

Sold in case pack or eaches.

Also available in clear.



SERVING SPOONS

- One-piece polycarbonate construction – recommended for temperatures up to 212°F; withstands dry heat up to 270°F
- Handle has notch so spoon can rest on edge of food pan – slot at end for hanging
- Cs Pk 12 x 1 ea

Item #	Mfg. #	Color	Cs Wt
Solid, 11" long			
380646	441003	Black	1.40 lb
380645	441007	Clear	1.40 lb
Perforated, 11" long			
380648	441103	Black	1.39 lb
380647	441107	Clear	1.39 lb
Solid, 13" long			
397366	442006	Beige	1.65 lb

Sold in case pack or eaches.

CARLY® TONGS

- So tough, they carry a two-year warranty (colored tongs only)
- Tough plastic can be used on high temperature surfaces like steam tables – withstands heat up to 300°F



Item #	Mfg. #	Description	Cs Pk	Cs Wt
Salad Tongs				
380650	460606	6", Beige	12 x 1 ea	1.08 lb
380649	460603	6", Black	12 x 1 ea	1.08 lb
397831	460601	6", Reddish/Brown	12 x 1 ea	1.08 lb
397456	400607	6", Clear	12 x 1 ea	1.08 lb
380652	460906	9", Beige	12 x 1 ea	2.30 lb
380651	460903	9", Black	12 x 1 ea	2.30 lb
Pom Tong				
397256	480606	6", Beige	12 x 1 ea	1.08 lb

Item #	Mfg. #	Description	Cs Pk	Cs Wt
Utility Tongs				
380656	470906	9", Beige	12 x 1 ea	2.00 lb
380655	470903	9", Black	12 x 1 ea	2.00 lb
380661	410907	9", Clear	12 x 1 ea	2.04 lb
380654	471206	12", Beige	12 x 1 ea	2.04 lb
380653	471203	12", Black	12 x 1 ea	2.04 lb

Sold in case pack or eaches.

BUFFET & CATERING



#TG12

#TG6



LUGANO® TONGS

- Colored tongs are made from durable heat resistant material that withstands temps to 300°F
- Clear tongs are made from virtually unbreakable polycarbonate, which is safe to 210°F
- Flat grip surface is ribbed for secure hold
- One piece design
- Dishwasher safe

Item #	Mfg. #	Description	Cs Pk	Cs Wt
381670	TG6-133	6", Beige	12 x 1 ea	0.96 lb
388039	TG6-135	6", Clear	12 x 1 ea	0.96 lb
381671	TG9-133	9", Beige	12 x 1 ea	1.68 lb
388038	TG12-135	12", Clear	12 x 1 ea	0.96 lb

Sold in case pack or eaches.

PLASTIC CLEANING TIPS

The cleaning of most plastic is determined by the specific plastic used. When in doubt ask the manufacturer. Find out the maximum temperature the product can withstand, how to wash and if the product is safe to use in the microwave.

Acrylic

Hand wash using mild liquid dish soap and dry with a soft cotton cloth.
Do not use Windex or similar cleaners.
Do not use at temps above 160°F.
Not recommended for microwave.

Polycarbonate

Hand wash using mild liquid dish soap and dry with a soft cotton cloth.
Do not use Windex or similar cleaners.
Do not use at temps above 200°F.
Not recommended for microwave.

INSULATED CAMCARRIERS®

Front Loading

- Rugged and dependable
- Individual track for each food pan
- Holds multiple combinations of 6", 4" and 2½" deep food pans
- Keeps food hot or cold for hours without any external source

18"w x 25"d x 24⅞"h

Color: Dark Brown

Item #415279

Mfg. #UPC400-131

Cs Pk 1 x 1 ea

Cs Wt 35.23 lb

18"w x 26¼"d x 25"h

Color: Dark Brown

Item #369885

Mfg. #300MPC-131

Cs Pk 1 x 1 ea

Cs Wt 30.17 lb

18"w x 26¼"d x 25"h

Color: Black

Item #431125

Color: Black

Mfg. #300MPC-110

Cs Pk 1 x 1 ea

Cs Wt 30.17 lb

Shown with optional food pans.

#CP1220-159



#UPC400-131
Stocked in dark brown only.

Shown with optional ThermoBarrier, food pans



#CD400-131
Stocked in black only.

OPTIONAL ACCESSORIES for Camcarriers & Pan Carrier

Item #	Mfg. #	Description	Cs Pk	Cs Wt
384353	CP1220-159	Camchiller®	1 x 1 ea	8.15 lb
393208	CD400-110	Camdolly®, Black	1 x 1 ea	19.60 lb

ULTRA PAN CARRIER® S-SERIES

- Polyethylene construction
- Stores hot and/or cold foods
- Temperature retention for hours
- Doors open 270° for easy loading/unloading
- Holds (6) 2½"d, (4) 4"d, (3) 6"d or (2) 8"d full size food pans
- 18"w x 26¼"d x 25"h • Color: Dark Brown

Item #478179*

Mfg. #UPCS400-131

Cs Pk 1 x 1 ea

Cs Wt 47.50 lb

* Special order



Shown with optional dividers and fractional sized food pans.



Top Loading

- 20 qt capacity
- Holds one 6"d full size pan or fractional sizes with divider bars
- Molded in handles on all four sides
- 24¾"w x 17⅞"d x 10⅞"h
- Color: Dark Brown

Item #458175

Mfg. #UPC160-131

Cs Pk 1 x 1 ea

Cs Wt 18.56 lb



Stocked in dark brown only.

CAMSERVER®

- 5 gal capacity
- Thick foam insulation holds coffee hot for hours with no external power
- Great tasting coffee without the hassles involved with canned heating fuels or burned out electrical elements
- Convenient, safe top filling with self-sealing gasket to help hold temperatures
- Durable, full size nylon latches open and close easily
- Includes two attractive brass identity plates: coffee/decaf or tea/hot water
- 13¼"w x 18⅞"d x 28"h
- Color: Black

Item #380611*

Mfg. #CSR5-110

Cs Pk 1 x 1 ea

Cs Wt 21.79 lb

* Special order



CAMTAINER® INSULATED CONTAINERS

- One-piece polyethylene outer shell combined with thick foam core insulates against heat loss for hours
- Molded-in mounting plates prevent latches from pulling out
- Beverage containers have drip-proof recessed spigots for clean, easy access
- Includes a self-adhesive beverage label set

Item #	Mfg. #	Description	Cs Pk	Cs Wt
Beverage Containers				
398914	250LCD-110	Black, 2½ gal	1 x 1 ea	12.77 lb
369836	250LCD-131	Dark Brown, 2½ gal	1 x 1 ea	12.77 lb
380429	500LCD-131	Dark Brown, 4¾ gal	1 x 1 ea	15.48 lb
460012	500LCD-110	Black, 4¾ gal	1 x 1 ea	15.48 lb
Soup Container-No Spigot				
442083	350LCD-131	Dark Brown, 3⅞ gal	1 x 1 ea	13.40 lb



#500LCD-131

9"w x 16½"d x 24¼"h

#250LCD-131

9"w x 16½"d x 18⅞"h

#350LCD-131(soup)
9"w x 16½"d x 18⅞"h



HEATED ULTRA PAN CARRIER® & CAMCART®

- Gentle heat (150° to 165°F) warms and keeps food moist
- 45-minute preheat, 3-minute recovery when door is opened/closed
- Excellent temperature retention – even when unplugged for hours
- Tough, polyethylene exterior stays cool to the touch
- Color: Black • 110V



Ultra Pan Carrier®
18½" w x 26¾" d x 24⅞" h
1-Compartment

Item #532107*
Mfg. #UPCH400-110
Cs Pk 1 x 1 ea
Cs Wt 45.00 lb

* **Special Order**

2-Compartment Hot Holding Ultra Camcart®
20½" w x 27⅞" d x 54" h
Includes 5" casters

Item #497569
Mfg. #UPCH800-110
Cs Pk 1 x 1 ea
Cs Wt 102.00 lb



#UPCH800-110

CAMTHERM® FOOD HOLDING CABINETS

- Tall profile – keeps cold food cold, hot food hot, moist food moist and crisp food crisp
- Thick polyurethane foam insulation keeps tough polyethylene exterior cool and safe to the touch
- Uses environmentally-friendly technology
- Fahrenheit thermometer
- Hold (22) 18" x 26" sheet pans or (24) full size food pans, 2½" deep
- Front 6" swivel casters w/brake, 10" rear wheels
- 30½" w x 39" d x 64¾" h
- Hot Only model is Energy Star qualified
- 125V • 1800 watts



#CMBHC1826TBF-194

Hot Only, Granite Gray

Item #531797
Mfg. #CMBH1826TBF-191
Cs Pk 1 x 1 ea
Cs Wt 290.60 lb



Hot/Cold, Granite Sand

Item #523116
Mfg. #CMBHC1826TBF-194
Cs Pk 1 x 1 ea
Cs Wt 358.82 lb



TABLE TOP FOOD BAR

- Thick foam ice well holds ice for hours to keep food fresh
- Drain plug included to make clean up quick and easy
- Double-sided sneeze guard included
- End panels shield food for even greater food protection
- Holds 4 full size pans (not included) • 63½" long
- Color: Black

Item #516013
Mfg. #5FBRTT-110
Cs Pk 1 x 1
Cs Wt 92.20 lb



CAMBRO
TRUSTED FOR GENERATIONS™



VERSA FOOD BARS™

CAMBRO
TRUSTED FOR GENERATIONS™

- Stylish and completely portable
- Versatile with countless configurations
- Food Bars – 42½" w x 62¾" h; Tray Rails – 11½" x 4⅞" h
- Optional corner connector allows you to connect two food bars to create an upscale buffet • Cs Pk 1 x 1 ea



Item #	Mfg. #	Length	Capacity	Cs Wt
Food Bars – Black				
521415	VBR5-110	5'	(4) Full Pans	184.00 lb
531803	VBR6-110	6'	(5) Full Pans	219.00 lb
Tray Rails – Granite Gray				
531805	VBRR5-191	5'		12.66 lb
528811	VBRR6-191	6'		15.57 lb

Rails sold separately



Items noted with an FOB truck are FOB Factory. Freight charges will be added to all orders placed. Non-returnable items.



TRUFINISH™ CLASSIC™ TWILL WEAVE SHIRRED SKIRTING

- 100% polyester
- Minimal fading, shrinking and wrinkling
- Simply wash and dry
- Flame retardant
- 17' long x 29" high
- Includes velcro and plastic clips
- Cs Pk 1 x 1 ea
- Cs Wt 5.00 lb

Item #	Mfg. #	Description
420360	5024EA29AF010	White
420362	5024EA29AF046	Burgundy



White



Burgundy



SOFTWEAVE™ NAPKINS

- Spun filament polyester fabric by Milliken, provides the look and feel of cotton without fading or shrinking
- Excellent resistance to pilling and snagging
- Liquids absorb quickly
- Proven soil release for tough-to-remove stains
- 20" x 20"
- Cs Pk 1 x 1 dz
- Cs Wt 2.00 lb



White



Forest Green

Item #	Mfg. #	Description
420363	53782020NM010	White
420364	53782020NM046	Burgundy
420365	53782020NM064	Forest Green



Burgundy

Sold in case pack only.



DURALAST™ TABLECLOTHS

- 100% polyester fabric by Milliken resists fading, shrinking and wrinkling
- Releases stains, soil and odors in the wash
- Absorbs liquids for easy spill clean-up
- White

Item #	Mfg. #	Description	Cs Pk	Cs Wt
420366	53695252SMDF	52" x 52"	1 x 4 ea	11.00 lb
420367	536952AITMDF	52" x 108"	1 x 1 ea	7.67 lb

Sold in case pack only.

CLASSIC™ SERIES TABLECLOTHS

- Flame retardant, economical 4 gauge vinyl with 1.8 oz polyester backing
- Real savings over linens that require laundering
- Affordable way to redecorate
- Easy clean-up with a damp cloth



Check



Damask
Lace

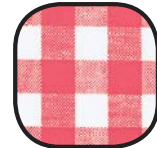

Gavin
Check

Item #	Mfg. #	Description	Cs Pk	Cs Wt
423279	51511554L001	Check, 15 yards, Red	1 x 1 roll	10.00 lb
423288	51785252010	Damask Lace®, 52" x 52", White	1 x 1 dz	11.00 lb
423290	51531554L001	Gavin Check®, 15 yards, Red	1 x 1 roll	10.00 lb

Sold in case pack only.

STERNO™ DECORATIVE LIGHTING PETITELITES® DISPOSABLE CANDLES

- Delicate shape and size, perfect for nearly every occasion
- Use them once and toss them out
- Saves time and money
- Glass is recyclable
- 2" high



Item #	Mfg. #	Description	Cs Pk	Cs Wt
383778	530F	5 hr, Frosted	1 x 48 ea	10.00 lb
372372	530A	5 hr, Clear	1 x 48 ea	10.00 lb
385502	530A8	8 hr, Clear	1 x 48 ea	11.40 lb

Sold in case pack only.

FOOD WARMERS & TEALIGHTS

- Clean burning
- Color: White

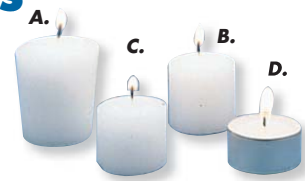

Item #	Mfg. #	Description	Cs Pk	Cs Wt
Food Warmers				
A. 374173	516FW	15 hr	4 x 36 ea	14.70 lb
439791	516FW2	15 hr	8 x 36 ea	27.00 lb
B. 381826	510FW	10 hr	4 x 72 ea	18.50 lb
C. 370483	508FW	8 hr	6 x 72 ea	27.90 lb
Tealights				
D. 367907	505TL	5 hr	10 x 50 ea	17.50 lb

Sold in case pack only.

DINING / TABLE SERVICE

BIRTHDAY CANDLES

- Assorted colors
- Box of 24 candles

Item #	Mfg. #	Description	Cs Pk	Cs Wt
487260	603	2 1/8" long, Plain	12 x 12/24 ea	8.70 lb
382017	601	2 1/4" long, Striped	12 x 12/24 ea	12.00 lb

Sold by case pack or 12/24 pack.



#603



#601



TAPER CANDLES

- Odorless
- Dripless

Item #	Mfg. #	Description	Cs Pk	Cs Wt
382021	610WH	10", White	12 x 1 dz	18.70 lb
382022	612RD	12", Red	12 x 1 dz	22.40 lb
382023	612WH	12", White	12 x 1 dz	22.40 lb
382024	615WH	15", White	12 x 1 dz	29.50 lb

15" 12" 12" 10" *Sold in case pack and by dozen.*

TABLETOP LIGHTING

Tabletop lighting creates a quiet intimate atmosphere for less than 2 cents per hour. It is the most cost effective way to change your restaurant décor and give it a fresh, new look. Check averages will increase. Customers tend to stay longer and order dessert and after dinner drinks. For a small additional cost candle lamps can bring incremental profits.

NAPKIN FOLDING

Pyramid Fold

Fold napkin in half diagonally (1). Fold corners to meet top point (2). Turn napkin over and fold in half (3). Pick up at center and stand on base of triangle (4).

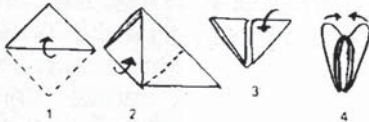

Goblet Fold

Fold napkin in half (1). Pleat from bottom to top (2). Turn napkin back 1/3 of the way on right (folded) end and place into goblet (3). Spread out pleats at top (4).

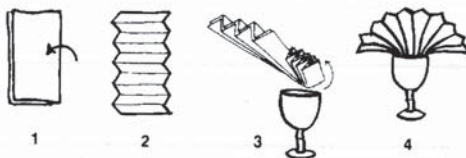

Bird Of Paradise Fold

Fold napkin in half and in half again (1). Then fold in half diagonally with points on the top and facing up (2). Fold left and right sides down along center line, turning their extended points under (3). Fold in half on long dimension with edges facing out (4). Pull up points and arrange on fabric surface (5).

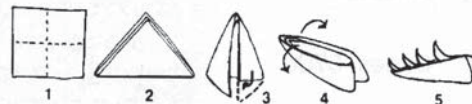

Cardinal's Hat Fold

Fold napkin in half diagonally (1). Fold corners to meet at top point (2). Turn napkin over with points to the top, fold lower corner 2/3 way up (3). Fold onto itself (4). Bring corners together tucking one into the other - open base of fold and stand upright (5).

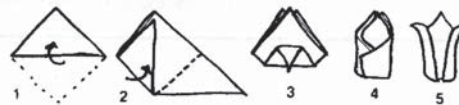

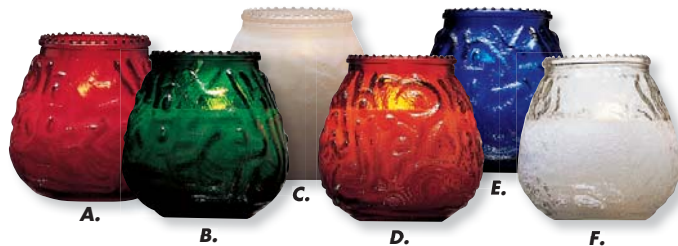

EURO-VENETIAN® FILLED GLASS CANDLES

- 60 hour burn time
- 3¼" high
- Scratch resistant, water based painted glass



Item #	Mfg. #	Color	Cs Pk	Cs Wt
A. 371379	234V-1-RD	Red	1 x 15 ea	15.20 lb
505242	234RD-6	Red	4 x 6 ea	24.20 lb
B. 378924	234V-1-GR	Green	1 x 15 ea	15.20 lb
C. 378936	234V-4	Frost White	1 x 15 ea	15.20 lb
505244	234FR-6	Frost	4 x 6 ea	24.20 lb
D. 377374	234V-1-AM	Amber	1 x 15 ea	15.20 lb
E. 387227	234V-1-BL	Blue	1 x 15 ea	15.20 lb
F. 385237	234V	Clear	1 x 15 ea	15.20 lb

Sold in case pack only.

STERNO® BRAND DISPOSABLE BUTANE LIGHTER

- Extended neck and safety button



Item #367936

Mfg. #897
Cs Pk 1 x 12 ea
Cs Wt 1.80 lb

Sold in case pack only.



EURO LOWBOY® FILLED GLASS CANDLES

- 60 hour burn time
- 3¼" high
- With netting



Item #378930

Mfg. #231RD
Cs Pk 1 x 15 ea
Cs Wt 15.00 lb

Sold in case pack only.



STERNO® CRYSTALYTE® LIQUID WAX CARTRIDGES

- Virtually odorless
- No messy clean-up
- Burns bright and clean



Not Available
via FedEx®.

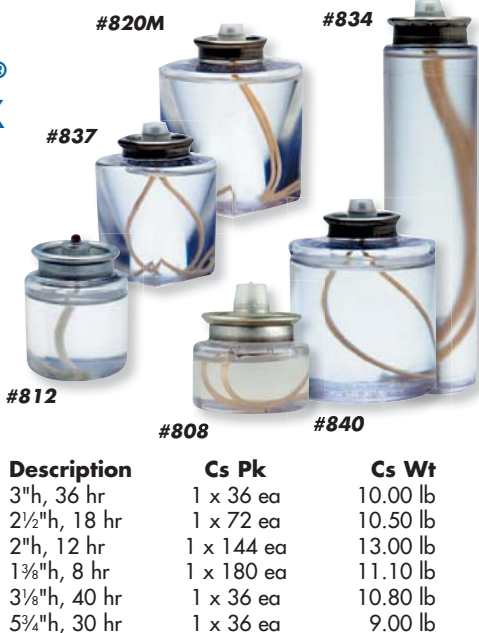

Item #	Mfg. #	Description	Cs Pk	Cs Wt
406597	837	3"h, 36 hr	1 x 36 ea	10.00 lb
396011	820M	2½"h, 18 hr	1 x 72 ea	10.50 lb
444486	812	2"h, 12 hr	1 x 144 ea	13.00 lb
459619	808	1¾"h, 8 hr	1 x 180 ea	11.10 lb
367909	840	3⅞"h, 40 hr	1 x 36 ea	10.80 lb
367918	834	5¾"h, 30 hr	1 x 36 ea	9.00 lb

Sold in case pack only.

STERNO® DECORATIVE LIGHTING

Eclectic

- Diamond Lyte™
- Clear, 5" high
- Use #837 or #840 liquid wax cartridge



Item #370575

Mfg. #494-CL
Cs Pk 1 x 6 ea
Cs Wt 8.25 lb

Sold in case pack only.

Petite Holder

- Amber Beaded Mosaic, 4½" high
- Use #812 liquid wax cartridge



Item #466955

Mfg. #1200AM
Cs Pk 1 x 6 ea
Cs Wt 6.00 lb

Sold in case pack only.



STERNO® CRYSTALYTE® LIQUID WAX REFILL

- For use in refillable cartridges

1 gallon – Pump included

Item #368015

Mfg. #220

Cs Pk 4 x 1 gal

Cs Wt 28.90 lb



2.5 gallon – Pump not included

Item #367900

Mfg. #221

Cs Pk 2 x 2.5 gal

Cs Wt 35.70 lb



Not Available
via FedEx®.



FLAMELESS™ TEALIGHT CARTRIDGE

- Heatless, wax-free cartridge offers a safe and hassle-free alternative to flame-based lighting
- Provides up to 65 hours of light
- 1¼" high

Item #452272

Mfg. #3505AF

Cs Pk 1 x 50 ea

Cs Wt 2.50 lb

Sold in case pack only.



COFFEE URNS

- These stainless steel urns are fast!
- Brewing 36 cups in about 30 minutes
- Feature mug clearance and dual thermostats for durability and optimum coffee serving temperature
- Signal light to indicate when coffee is ready
- Interior water level markings
- Made in the USA
- Cs Pk 1 x 1 ea



Item #	Mfg. #	Description	Cs Wt
397971	K1355A	55 Cup	10.10 lb
397972	K1301A	110 Cup	15.50 lb



COFFEE MAKERS

- Heavy-duty aluminum percolators brew perfect coffee and automatically hold it at the ideal serving temperature
- Feature non-drip faucet, stay-cool phenolic handles and knob
- Signal light indicates when coffee is brewed
- Available in polished or black satin banded exterior
- Made in USA
- 120V
- Cs Pk 1 x 1 ea



Item #	Mfg. #	Description	Cs Wt
426454	58001R	12-101 Cup, Aluminum	9.25 lb
426472	58055R	12-55 Cup, Aluminum	6.87 lb
426455	58230R	10-30 Cup, Aluminum	4.00 lb
426473	58101R	12-101 Cup, Black Exterior	9.25 lb
426474	58155R	12-55 Cup, Black Exterior	6.87 lb



Decanters sold separately

BUNN

COFFEE BREWERS

- 12 cup coffee brewers
- All stainless steel construction
- Automatic – hot water faucet and back-up pourover feature (#12950.0212 and #12950.0213)
- SplashGard® funnel deflects hot liquids away from the hand
- Separately controlled warmers
- 120V
- Cs Pk 1 x 1 ea

Item #	Mfg. #	Description	Cs Wt
Automatic Coffee Brewers			
497068	12950.0212	3.9 gal/hr, 3 Warmers	37.90 lb
497066	12950.0213	Space Saving, 3.8 gal/hr, 3 Warmers	33.00 lb
Low Profile Pourover Coffee Brewers			
501860	13300.0002	3.9 gal/hr, 2 Warmers	24.00 lb
497697	13300.0003	3.8 gal/hr, 3 Warmers	29.00 lb

POUROVER COFFEE BREWER

- 12 cup brewer
- Brews up to 3.8 gallons per hour
- Two separately controlled warmers
- Internal components are stainless steel
- Requires no plumbing, completely portable
- Pour cold water in top and coffee brews instantly
- SplashGard® funnel deflects hot liquids
- 120V

Item #497070
Mfg. #33200.0000
Cs Pk 1 x 1 ea
Cs Wt 23.00 lb



DINING / TABLE SERVICE



COFFEE WARMER

- Stainless steel cabinet
- Separate "on-off" switches
- 120V
- 14"w x 7"d x 2.5"h

Item #497074
Mfg. #06310.0004
Cs Pk 1 x 1 ea
Cs Wt 4.00 lb

COFFEE WARMER

- Keeps brewed coffee at optimal temperature
- All stainless steel construction
- Fits on counter tops and under cabinets
- 1-piece porcelain enameled warmer plates
- Double, 15½"w x 7½"d x 3"h
- 120V

Item #493435
Mfg. #8852
Cs Pk 1 x 1 ct
Cs Wt 2.00 lb



Decanters sold separately



PLASTIC WATER PITCHER

- Use with all 12 cup commercial pourover coffee makers
- Built in handle makes it easy to pour
- 64 oz capacity

Item #514011
Mfg. #04238.0000
Cs Pk 1 x 1 ea
Cs Wt 0.37 lb



SPLASHGARD® FUNNEL

- Black plastic funnel with decals
- Protects employees from accidental spills when they remove filter too quickly
- Hot liquids are deflected in this improved funnel design
- For use with many brewers



Item #498609
Mfg. #20583.0003
Cs Pk 1 x 1 ea
Cs Wt 0.50 lb



#34100.0000



#33000.0001

ICED TEA DISPENSERS

- Cylinder style dispensers
- Sump dispense valve assures complete dispensing of tea
- Faucet handles are labeled sweetened and unsweetened
- Handles are mounted offset for closer side-by-side positioning
- Cs Pk 1 x 1 ea

Item #	Mfg. #	Description	Cs Wt
497696	34100.0000	4 gal, Solid Plastic Lid	12.20 lb
516978	33000.0001	5 gal, Stainless Steel Lid	12.00 lb

EASY CLEAR® WATER QUALITY SYSTEM

- High performance 25,000 gallon water quality system
- For Example (6 month period): 345 cups of coffee, 110 glasses of ice tea, 200 cups of cappuccino per day and 1200 lb Flaker Ice Machine (totalling 25,000 gallon)
- For use in high volume applications where scale inhibitor is needed
- Consistent great-tasting brewed coffee and tea from water with reduced sediment and chlorine taste and odor
- System includes a head assembly, integral mounting bracket and single cartridge filter

Item #497126
Mfg. #39000.0002
Cs Pk 1 x 1 ea
Cs Wt 3.30 lb



TABZ™ COFFEE BREWER CLEANING TABLETS

- Super concentrated cleaning tablets
- Optimizes portion control and cleaning
- Cleans brew basket and server in one simple step
- Eliminates dust, waste and operator error

Item #497144
Mfg. #39637.0001
Cs Pk 12 x 120 ct
Cs Wt 14.90 lb



UNBREAKABLE COFFEE DECANTERS

- Durable UDEL™ polysulfone (plastic) and stainless steel construction
- 10-12 cup capacity
- Dishwasher safe
- Cs Pk 1 x 3 ea



Item #	Mfg. #	Description	Cs Wt
379733	8895	Regular, Black handle and lip	4.00 lb
371137	8885	Decaf, Orange handle and lip	4.00 lb

Sold in case pack only.

GLASS COFFEE DECANTERS

- 10-12 cup capacity
- Cs Pk 1 x 3 ea



Item #	Mfg. #	Description	Cs Wt
379721	8903	Regular, Black handle and lip	4.00 lb
379731	8913	Decaf, Orange handle and lip	4.00 lb

Sold in case pack only.

COFFEE DECANTERS

- Glass decanters
- 12 cup, 64 oz capacity



Item #	Mfg. #	Description	Cs Pk	Cs Wt
497112	06078.0003	Regular, Black handle	1 x 3 ea	4.50 lb
497122	06078.0024	Regular, Black handle	1 x 24 ea	26.00 lb
497123	06088.0003	Decaf, Orange handle	1 x 3 ea	4.50 lb
497125	06088.0012	Decaf, Orange handle	1 x 12 ea	14.00 lb

Sold in case pack only.



COFFEE DECANTERS

- Mirror-finished stainless steel
- Comfortable black plastic handles
- Designed to fit standard stove top and coffee warmers
- 64 oz capacity

Regular
Item #380361
 Mfg. #46570
 Cs Pk 1 x 1 ea
 Cs Wt 1.42 lb

EASY POUR® COFFEE DECANTERS

- 1 piece high impact container handle with high quality stainless steel base
- Drip-proof, fast-pour lip
- 64 oz capacity
- Cs Pk 1 x 3 ea
- Cs Wt 3.00 lb



Item #	Mfg. #	Description
497099	06100.0103	Regular, Black handle
497110	06101.0103	Decaf, Orange handle

Sold in case pack only.

DECANTERS

- Unbreakable polycarbonate with stainless steel base
- 64 oz
- Cs Pk 6 x 1 ea



Item #	Mfg. #	Description	Cs Wt
476319	CD-8890	Regular, Black handle and top	6.16 lb
476320	CD-8890/OR	Decaf, Orange handle and top	6.16 lb

Sold in case pack or eaches.

DECANTER

- Unbreakable
- Stainless steel with ABS handle
- 64 oz



Item #476195
 Mfg. #DSS-12/BK
 Cs Pk 12 x 1 ea
 Cs Wt 18.40 lb
Sold in case pack or eaches.

COFFEE DECANTERS

Swirled White or Black Decanters

- Plastic • Triple wall insulation
- Color tag set included: brown for regular, orange for decaf, green for water, tea, etc.



Item #	Mfg. #	Description	Cs Pk	Cs Wt
DECANTERS				
380219	442	20 oz, White	1 x 1 ea	1.12 lb
380220	444	40 oz, White	1 x 1 ea	1.95 lb
409024	474	40 oz, Black	1 x 1 ea	1.95 lb
380221	447	64 oz, White	1 x 1 ea	2.80 lb
429962	477	64 oz, Black	1 x 1 ea	2.80 lb
TOP				
441766	444T	For 444, White	1 x 1 ea	0.16 lb

THERMAL CARAFES

- 18/10 stainless steel exterior
- Wide, stable base and drip-free spout
- Stainless steel inner lining
- Keeps beverage hot or cold for hours
- Cs Pk 1 x 1 ea



Item #	Mfg. #	Description	Cs Wt
482557	KPW9111	1.0 Liter, Polished Exterior	1.73 lb
482558	KPW9112	1.5 Liter, Polished Exterior	1.98 lb
482559	KPW9113	2.0 Liter, Polished Exterior	2.49 lb
423178	KPW9101	2.0 Liter, Brushed Exterior	2.20 lb

HOTTLE & COVER

- 10 oz glass jar
- Black collar and cover

Hottle & Cover Item #380186 Mfg. #B3650 Cs Pk 1 x 2 dz Cs Wt 18.00 lb	Cover Only Item #380187 Mfg. #BT3650 Cs Pk 1 x 1 dz Cs Wt 0.75 lb
--	--



ESPRESSO MILK / FROTHING PITCHER

- Made of 18/8 stainless steel
- Great for frothing
- 33 oz

Item #482349 Mfg. #EP-33 Cs Pk 24 x 1 ea Cs Wt 22.00 lb



Sold in case pack or eaches.

BEVERAGE SERVERS

- Black and gold traditional coffee servers
- Wide mouth and thumb control top for easy usage



Item #	Mfg. #	Description	Cs Pk	Cs Wt
476197	H422/20	20 oz	24 x 1 ea	22.00 lb
476198	H422/32	32 oz	24 x 1 ea	33.94 lb
476201	H422/64	64 oz	12 x 1 ea	26.62 lb

Sold in case pack or eaches.

SUP-R-SERV® COFFEE SERVER

- Double wall insulated stainless steel
- Push button top • Superior heat retention
- Black and stainless • 64 oz/1.9 liter



Item #476204

Mfg. #SA-19X
Cs Pk 6 x 1 ea
Cs Wt 20.90 lb

Sold in case pack or eaches.

AUTOPOUR BRUSHED SERVERS

- The AutoPour stopper is easy to use and it seals itself when not in use
- Glass vacuum liner keeps coffee hot for hours
- 1 liter • Cs Pk 24 x 1 ea
- Cs Wt 53.00 lb

#UD1000N



Item #	Mfg. #	Description
485038	UD1000N	Black & Brushed Nickel Finish
479100	UD1000P	Brown and Brushed Copper

Sold in case pack or eaches.

CARAFES

- Glass lined
- Vacuum insulated
- Click and pour
- Excellent heat retention
- Color: Black and stainless



Item #	Mfg. #	Description	Cs Pk	Cs Wt
476312	AIS-100	33 oz	24 x 1 ea	53.00 lb
476313	AIS-190	64 oz	12 x 1 ea	39.60 lb

Sold in case pack or eaches.

CREAM SERVERS

- Stainless steel lined • Vacuum insulated
- Lightweight and easy to clean
- Easy to use twist off tops
- Ideal for self-serve environments
- Black and stainless

24 oz Item #482430 Mfg. #SV-70 Cs Pk 12 x 1 ea Cs Wt 18.00 lb	33 oz Item #476205 Mfg. #SV-100 Cs Pk 12 x 1 ea Cs Wt 22.00 lb
--	---

Sold in case pack or eaches.



BUNN



#32125.0000

AIRPOTS

- Stainless steel lining keeps coffee hot for hours
- Brew-through lid with lever-action for easy use
- Cs Pk 1 x 1 ea

Item #	Mfg. #	Description	Cs Wt
497075	32125.0000	2½ Liter (84 oz)	5.35 lb
497078	32130.0000	3 Liter (102 oz)	5.84 lb

BLOOMFIELD

AIRPOT DISPENSERS

- Glass liners
- Economy metal body
- Brew-thru stem
- Designed to hold coffee at optimal temperature and flavor for hours
- 360° swivel base
- 74 oz or 2.2 liter capacity



#7759

#7760

Push Button Dispensing
Item #379737
 Mfg. #7759
 Cs Pk 1 x 1 ea
 Cs Wt 3.50 lb

Lever Pump Dispensing
Item #471810
 Mfg. #7760
 Cs Pk 6 x 1 ea
 Cs Wt 28.00 lb

Sold in case pack or eaches.



VACUUM INSULATED AIRPOTS

- Keeps hot liquids hot or cold liquids cold for hours
- Double-walled stainless steel construction – no glass to break
- Push button dispensing
- Convenient carrying handle folds down when not in use
- Easy to clean



#908830PB

#908825PB

2½ liter
Item #539079
 Mfg. #908825PB
 Cs Pk 1 x 1 ea
 Cs Wt 4.23 lb

3 liter
Item #539081
 Mfg. #908830PB
 Cs Pk 1 x 1 ea
 Cs Wt 4.80 lb



#LSVL-25/BK/BT



AIRPOTS

- Black and brushed stainless steel body
- Bru-thru stem
- 2.5 liter w/stainless steel liner
- Cs Pk 6 x 1 ea

Item #	Mfg. #	Description	Cs Wt
476368	LSVL-25/BK/BT	Black Lever Top	31.00 lb
476202	PSVL-25/BK/BT	Black Push Button Top	30.80 lb

Sold in case pack or eaches.

SERVERS

- Stackable
- Stainless steel
- Flat recessed lid design for stacking
- ¾" high • 10 oz



Item #371129
 Mfg. #46212
 Cs Pk 1 x 1 dz
 Cs Wt 3.60 lb
Sold in case pack only.



Setting the Standard™



- Value priced
- Stainless steel
- 4" high
- 10 oz

Item #371033
 Mfg. #46210
 Cs Pk 1 x 1 dz
 Cs Wt 4.46 lb
Sold in case pack only.

2 Airpot Model Shown



Your Name Here

AIRPOT RACKS

- Holds 3 airpots
- Complete with drip tray (K.D.)
- Color: Black wire

Item #497116
 Mfg. #APRK-3
 Cs Pk 1 x 1 ea
 Cs Wt 6.30 lb



SERVER

- 10 oz

Item #484615
 Mfg. #ESC-10
 Cs Pk 1 x 1 dz
 Cs Wt 4.18 lb
Sold in case pack only.



BEVERAGE DISPENSERS

- Reservoir with convenient quart and liter capacity indicators on both sides
- Deluxe spring action black faucet
- Includes one set of labels: Fruit Punch, Iced Tea, Lemonade, Sweetened Tea and Unsweetened Tea



Trimline™ Dispenser

Item #380741

Mfg. #1085003

3 Gallon Capacity, Black Base & Lid, Crystal Clear Polycarbonate Reservoir with Deluxe Faucet

Cs Pk 1 x 1 ea

Cs Wt 6.30 lb



Round Dispenser

Item #380740

Mfg. #222903

5 Gallon Capacity, Black Base, Translucent Polycarbonate Lid & Reservoir

Cs Pk 1 x 1 ea

Cs Wt 4.70 lb



SLIMLINE BEVERAGE DISPENSER

- FDA approved polypropylene plastic
- Hingeless cover design minimizes breakage
- Single, fast flow heavy duty Tomlinson® faucet
- Made from FDA approved polypropylene
- Graduations on side of reservoir
- Label not affixed
- 3 gallon
- Cs Pk 1 x 1 ea

Item #412567

Mfg. #356DPH

Cs Pk 1 x 1 ea

Cs Wt 6.00 lb



EVERY WARE. EVERY DAY.

BEVERAGE DISPENSERS

- FDA approved polypropylene plastic
- Durable, replaceable Tomlinson® faucet
- Half gallon graduations on side of reservoir
- Dishwasher safe and completely sanitary
- Labels not affixed
- Cs Pk 1 x 1 ea



EVERY WARE. EVERY DAY.

Item #	Mfg. #	Description	Cs Wt
Standard Faucet			
380223	953	3 gal, Black	4.70 lb
380222	955	3 gal, Yellow	4.70 lb
397383	1053	5 gal, Black	5.60 lb
Replacement Faucet			
429450	953F	Standard	0.10 lb



#953



#955



#1053

DRIP TRAYS

- Helps keep mugs, cups and pitcher bases dry
- Easy to clean
- Black
- Cs Pk 12 x 1 ea



#DT-3545

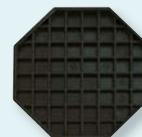

#DT-6X6

Item #	Mfg. #	Description	Cs Wt
Rectangle	(with sponge)		
476340	DT-3545	4½" x 3½" x ¾"	1.50 lb
Octagon			
476341	DT-6X6	6" x 6"	4.50 lb

Sold in case pack or eaches.



TRUSTED FOR GENERATIONS™



BEVERAGE DISPENSER W/HANDLE

- Holds 6 gallons
- Perfect for mixing and serving beverage concentrates
- White impact resistant polyethylene
- Standard and metric graduations printed on back of dispenser
- Bail & sure-grip handle
- Includes drip-proof spigot and handy lid
- Easy to carry
- 6 beverage labels included

Item #391151

Mfg. #DSPR6-148

Cs Pk 1 x 1 ea

Cs Wt 4.00 lb



SYRUP DISPENSERS & RACK

Item #	Mfg. #	Description	Cs Pk	Cs Wt
Syrup Dispensers				
A. 380185	1270	Glass Jar, 8 oz Modern, Chrome Plated ABS Top	1 x 1 dz	6.00 lb
B. 380190	1370	Glass Jar, 8 oz Modern, Chrome Plated Metal Top	1 x 1 dz	8.00 lb
C. 380188	406	Glass Jar, 6 oz Teardrop, Chrome Plated Metal Top	1 x 1 dz	7.68 lb
380189	414	Glass Jar, 14 oz Teardrop, Chrome Plated Metal Top	1 x 1 dz	13.56 lb
D. 380192	P410A	Polycarbonate Jar, 10 oz Teardrop, ABS Top, Almond	1 x 1 dz	2.40 lb
E. 380193	P410B	Polycarbonate Jar, 10 oz Teardrop, ABS Top, Brown	1 x 1 dz	2.40 lb
F. 380194	P410RE	Polycarbonate Jar, 10 oz Teardrop, ABS Top, Red	1 x 1 dz	2.40 lb
G. 397445	P10	Polycarbonate Jar, 10 oz, Chrome Metal Top	1 x 1 dz	4.40 lb
H. 380501	MW10	Milky White Polyethylene Jar, 10 oz Modern, Chrome Plated Metal Top	1 x 1 dz	4.40 lb
Rack				
I. 380191	1370R	Dispenser Rack, 3-ring Chrome Plated Metal, 3 1/4" I.D. Rings, Fits All Dispensers Above Except C. and D.	1 x 6 ea	4.99 lb
CASH & CARRY				
J. 423793	C406-4	Glass Jar, 6 oz Teardrop, Chrome Plated Metal Top	4 x 4 ea	10.00 lb



DINING / TABLE SERVICE

DRIPCUT® SERVER

- 6 oz glass jar with chrome plated top

Item #410170
Mfg. #206
Cs Pk 1 x 1 dz
Cs Wt 6.00 lb
Sold in case pack only.



OIL & VINEGAR CRUET AND RACK

- 6 oz square glass cruet with 18/8 stainless steel top
- Chrome plated metal rack

Cruet
Item #380178
Mfg. #600
Cs Pk 1 x 1 dz
Cs Wt 6.60 lb

Cruet Rack
Item #380179
Mfg. #600R
Cs Pk 1 x 6 ea
Cs Wt 3.46 lb



CASH & CARRY
6 oz. Cruet
Item #423848
Mfg. #C600-4
Cs Pk 4 x 4 ea
Cs Wt 8.00 lb
Sold in case pack only.

OIL & VINEGAR SET

- Two 6 oz. glass cruets with chrome plated ABS tops
- Stainless steel rack

Item #405645
Mfg. #600ST
Cs Pk 1 x 6 sets
Cs Wt 10.38 lb
Sold in case pack only.



GEMELLI™ OLIVE OIL BOTTLE SET

- Two - 8 1/2 oz glass bottles with green tint
- Chrome rack

Item #423242
Mfg. #H918N
Cs Pk 6 x 1 set
Cs Wt 15.30 lb
Sold in case pack or sets.



PRIMA™ OLIVE OIL BOTTLES & RACK SET

- Two 16 oz square glass bottles with green tint
- Chrome tapered pourers
- Chrome rack

Set
Item #420846
Mfg. #H916N
Cs Pk 6 x 1 set
Cs Wt 18.08 lb

Item #397429
Mfg. #916
Cs Pk 12 x 1 ea
Cs Wt 11.50 lb
Sold in case pack or sets.



DRIPCUT® CONDIMENT CADDY

- Keep tabletops and countertops well organized with this chrome-plated wire rack
- Holds (2) 2" square cruets

Item #513903
Mfg. #WR-1020
Cs Pk 1 x 6 ea
Cs Wt 2.60 lb
Sold in case pack only.



VERSA RACK™ CONDIMENT RACKS

- Black powder coated metal
- Built-in merchandising ring

Round Rack
6.79" dia

Item #482801

Mfg. #BK2679

Cs Pk 1 x 2 ea

Cs Wt 2.78 lb

Sold in case pack only.



Half Rack
8" x 5 3/4"

Item #482800

Mfg. #BK267912

Cs Pk 1 x 2 ea

Cs Wt 2.90 lb

Sold in case pack only.



Spoons sold separately.

J-JARS

- Ideal for all types of condiments
- Chrome plated wire caddy offers beauty and strength
- Color: Clear

Caddy w/3 J-Jars & lids

Item #380731

Mfg. #457307

Cs Pk 1 x 1 set

Cs Wt 1.75 lb

SYRUP PITCHER/CREAMER

- Easy pouring, no-drip lip design
- Stain-resistant, dishwasher safe SAN
- Safe in temperatures from 0° to 180°F
- 2 oz • Color: Clear

Item #380738

Mfg. #456007

Cs Pk 1 x 3 dz

Cs Wt 4.85 lb

Sold in case pack only.



CONDIMENT SPOON

- Clear polycarbonate
- 5 1/4" long

Item #380848

Mfg. #529-13

Cs Pk 1 x 1 dz

Cs Wt 0.30 lb

Sold in case pack only.



#593R

Containers sold separately.



#260R



#591C



#597C

CONDIMENT RACKS

- Organizes table and conserves space
- Easy carry ring holds "specials" cards
- Chrome plated metal



Item #	Mfg. #	Description	Cs Wt	Cs Wt
Sugar Packet/Salt & Pepper Rack				
380173	591C	Fits 1 1/8" dia Jars	1 x 1 dz	8.70 lb
380174	593R	Fits 1 1/8" dia Jars	1 x 1 dz	6.36 lb
Jelly Packet Rack				
380175	597C	Fits Jelly Packets up to 2" x 1 1/2"	1 x 1 dz	6.60 lb
Combo Rack				
386000	260R	1 1/8" and 3" ID rings	1 x 1 dz	9.87 lb

Sold in case pack only.



PEPPER MILLS

- Wood, walnut finish
- Traditional Italian craftsmanship
- Tempered steel grinding mechanisms for better grinding consistency and longer life
- Cs Pk 1 x 1 ea

Item #	Mfg. #	Description	Cs Wt
391328	PM2110	10" high	1.04 lb
380211	PM2112	12" high	1.26 lb
380212	PM2118	18" high	2.04 lb



SALT & PEPPER SHAKERS

Item #	Mfg. #	Description	Cs Pk	Cs Wt
18/8 Stainless Steel Top				
A. 380165	150S&P-2	Paneled, 1 oz	1 x 2 dz	4.27 lb
B. 380167	155S&P-2	Paneled, 2 oz	1 x 2 dz	6.29 lb
C. 380168	156S&P-2	Paneled, 3 oz	1 x 2 dz	9.10 lb
D. 380164	132S&P-2	Smooth, 3 oz	1 x 2 dz	7.54 lb
E. 380166	154S&P-2	Square, 2 oz	1 x 2 dz	7.47 lb
F. 380172	163S&P-2	Faceted, 1 1/2 oz	1 x 2 dz	5.75 lb
Chrome Plated Top				
G. 380169	30S&P	Cube, 1/2 oz	1 x 2 dz	2.07 lb
H. 380170	83S&P	Eiffel, 1 oz	1 x 2 dz	5.67 lb
Moisture Proof ABS Tops				
I. 480537	163MPW	1 1/2 oz, White Top	1 x 2 dz	6.00 lb
J. 480535	163MPBK	1 1/2 oz, Black Top	1 x 2 dz	6.00 lb
18/8 Stainless Steel Top - CASH & CARRY				
K. 423795	C155-12	Paneled, 2 oz	4 x 12 ea	10.45 lb
L. 423796	C154-12	Square, 2 oz	4 x 12 ea	13.00 lb
Chrome Plated Top - CASH & CARRY				
M. 423798	C83-12	Eiffel, 1 oz	4 x 12 ea	11.40 lb
Replacement Top Only (shown with shaker)				
E. 470259	154T	For 154S&P	1 x 1 dz	2.04 lb



SALT & PEPPER SHAKERS



Item #	Mfg. #	Description	Cs Pk	Cs Wt
Winchester Chrome Plated Brass Top				
A. 369414	70022	1 1/2 oz	1 x 2 dz	7.00 lb
Chrome Plated Plastic Top				
B. 369653	5221	1 1/4 oz	1 x 2 dz	9.00 lb
C. 369547	5037	1 1/2 oz	1 x 2 dz	11.00 lb
Aluminum Top				
D. 369557	5045	2 oz	1 x 6 dz	13.00 lb
Stainless Steel Top				
E. 379625	70017	1 oz	1 x 12 dz	20.00 lb
F. 369305	97052	2 oz	1 x 6 dz	22.00 lb

Sold in case pack only.

SALT & PEPPER SHAKERS

- Chrome plated metal top
- Cs Pk 1 x 1 dz
- Cs Wt 2.20 lb



Item #	Mfg. #	Description
Traditional™		
A. 380849	602-12	2 oz
Continental™		
B. 380853	802-12	2 oz

Sold in case pack only.



SALT & PEPPER SHAKERS

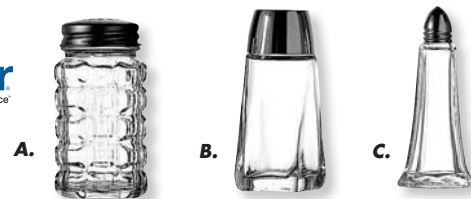

Item #	Mfg. #	Description	Cs Pk	Cs Wt
Sure Guard™ Aluminum Top				
A. 379046	1830EU	2 oz	1 x 3 dz	7.00 lb
Sure Guard™ Chrome Plated Top				
B. 379043	16U	2 oz	1 x 2 dz	11.00 lb
C. 379132	6099U	1 oz	1 x 2 dz	8.00 lb

Sold in case pack only.



SUGAR POURERS & CHEESE SHAKERS

Item #	Mfg. #	Description	Cs Pk	Cs Wt
Sugar Pourers - 12 oz Fluted Glass, Stainless Steel Tops				
A. 380181	57S-1	Side Flap Top	1 x 1 dz	11.00 lb
B. 380180	55S-1	Center Pour Top	1 x 1 dz	11.20 lb
Pourers & Shakers - 12 oz Polycarbonate, Stainless Steel Tops				
C. 398327	P800	Perforated Top	1 x 2 dz	5.40 lb
D. 398328	P57S	Side Flap Top	1 x 2 dz	5.40 lb
Cheese Shakers - 12 oz Fluted Glass, Stainless Steel Tops				
E. 380182	800-1	Perforated top	1 x 1 dz	10.80 lb
Cheese Shakers - 6 oz Swirled Glass, Chrome Plated Top				
F. 380184	260SL-1	Slotted Top	1 x 1 dz	5.17 lb
G. 380183	260-1	Perforated Top	1 x 1 dz	5.17 lb
Cheese Shakers - 6 oz Polycarbonate, Chrome Plated Top				
H. 397447	P260	Perforated Top	1 x 2 dz	3.00 lb
Sugar Pourers - 12 oz - CASH & CARRY				
I. 423847	C57S-4	Side Flap, Stainless Steel Tops	4 x 4 ea	14.60 lb
Cheese Shakers - 6 oz - CASH & CARRY				
G. 423846	C260-4	Perforated, Chrome Tops	6 x 4 ea	9.20 lb

Sold in case pack only.

SWIRL SHAKER

- Perforated chrome plated metal top
- 6 oz swirled glass container

Item #476426

Mfg. #SK-RPF
Cs Pk 1 x 3 dz
Cs Wt 17.00 lb

Sold in case pack only.



CHEESE SHAKER

- Polycarbonate w/stainless steel top
- 4 oz • Color: Clear

Item #417380

Mfg. #260
Cs Pk 1 x 1 dz
Cs Wt 2.00 lb

Sold in case pack only.



SALT & PEPPER REFILLERS

- Saves labor
- No messy cleanup
- ½ gallon capacity
- Cs Pk 4 x 1 ea
- Cs Wt 1.26 lb



Item # **Mfg. #** **Description**
436322 90S Salt Refiller
443167 90P Pepper Refiller
Sold in case pack or eaches.



CHEESE GRATER

- White plastic construction with metal cutting
- Effortless design takes the hassle out of grating hard cheeses at the dining table
- Dishwasher safe

Item #423845

Mfg. #174
Cs Pk 1 x 1 ea
Cs Wt 0.42 lb



GLASS JARS: HOW THEY DO & DON'T STACK UP

Environmentally speaking, glass food storage containers are one of the best options for both dry and wet foods. Not only can you avoid the waste of plastic bags or containers (not to mention Styrofoam or other earth unfriendly materials), but glass does not absorb odors and is dishwasher safe. The downside is their weight. Alone, glass containers are often hefty enough, but once you add food to them, you're adding considerable ounces or even pounds. When it comes to storage, this can be a problem. One easy way to avoid damage, is to never stack glass jars. The jars on the bottom of the stack can (and probably will, eventually) crack with the weight of the jars on top.



GRAVY/SAUCE BOATS

- Mirror-finished stainless steel
- Footed design with gadroon edge base
- Well balanced design makes pouring easy

Item #	Mfg. #	Description	Cs Pk	Cs Wt
379753	47573	3 oz	12 x 1 ea	2.40 lb
379756	47575	5 oz	12 x 1 ea	3.12 lb
379757	47578	8 oz	12 x 1 ea	4.92 lb

Sold in case pack or eaches.

PANELED SHERBET DISHES

- Mirror-finished stainless steel
- Wide gadroon base for added stability and style
- Scalloped top

3½ oz capacity – 1⅞" h

Item #371107

Mfg. #48013
Cs Pk 1 x 1 dz
Cs Wt 1.80 lb

Sold in case pack only.

5 oz capacity – 2¼" h

Item #379773

Mfg. #48015
Cs Pk 1 x 1 dz
Cs Wt 2.04 lb

Sold in case pack only.



AU GRATINS

- Mirror-finished stainless steel
- Use straight from the oven or broiler to the table
- Cs Pk 1 x 1 dz

Item #	Mfg. #	Description	Cs Wt
Round Au Gratin			
380441	47406	6 oz, 6¾" overall dia	3.48 lb
Oval Au Gratins			
380432	47428	8 oz, 8" x 4½" x 1⅞"	3.60 lb
380437	47422	12 oz, 9" x 5" x 1⅞"	5.40 lb

Sold in case pack only.

BUTTER MELTER

- Chrome plated welded wire stand
- Includes glass candle holder, candle and pan
- 3¼ oz, 5" high

Item #435272

Mfg. #46776
Cs Pk 1 x 1 dz
Cs Wt 10.20 lb

Sold in case pack only.



LOBSTER CRACKERS

- Chrome plated metal
- Double jaw

Item #380303

Mfg. # 514
Cs Wt 5.35 lb
Cs Pk 1 x 2 dz

Sold in case pack only.



LOBSTER CRACKERS

- Double jaw
- 6"
- Cs Pk 12 x 1 ea



#LC-01



Item #	Mfg. #	Description	Cs Wt
504860	LC-01	Stainless Steel	4.45 lb
504861	LC-03	Chrome	3.40 lb

Sold in case pack or eaches.

SAUCE CUP

- Stainless steel
- 2½ oz

Item #476416

Mfg. #SC-25
Cs Pk 12 x 1 dz
Cs Wt 1.30 lb

Sold in case pack or dozen.



SAUCE CUP

- Stainless steel
- Perfect for hot butter and sauces
- 3 oz

Item #367965

Mfg. #46713
Cs Pk 1 x 1 dz
Cs Wt 0.96 lb

Sold in case pack only.



DELUXE BELL PITCHERS

- Bell pitchers with ice catcher
- Heavy weight stainless steel
- Cs Pk 24 x 1 ea

#WPB-2C



Item #	Mfg. #	Description	Cs Wt
504954	WPB-2C	2 qt	37.20 lb
504955	WPB-3C	3 qt	50.16 lb

Sold in case pack or eaches.





CHALET BASKETS

- Chrome plated
- Hand wash only
- "Spoke" design
- Cs Pk 1 x 1 ea

Round, 9¾" x 3"
Item #397380
 Mfg. #4175
 Cs Wt 1.40 lb

Oval, 9⅞" x 6⅜" x 2¾"
Item #413157
 Mfg. #4174
 Cs Wt 0.95 lb

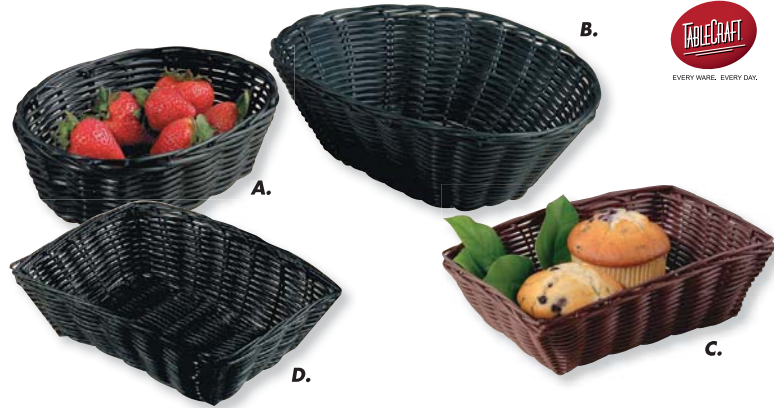

HANDWOVEN BASKETS

- Polypropylene cord
- Rich black or brown color
- Easy clean-up with damp cloth
- Cs Pk 1 x 1 dz

Item #	Mfg. #	Description	Cs Wt
A. 433559	2474	Oval, 9" x 6" x 2¼", Black	2.25 lb
B. 420325	2476	Oval, 10" x 6½" x 3", Black	2.85 lb
C. 414732	1472	Rectangular, 9" x 6" x 2½", Brown	2.50 lb
D. 475898	2472	Rectangular, 9" x 6" x 2½", Black	2.75 lb

Sold in case pack only.

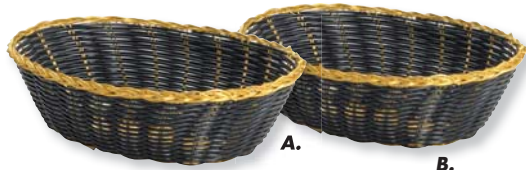

VINYL BASKETS

- Black woven vinyl with gold metal trim
- Won't absorb oil or odors
- Cs Pk 1 x 1 dz

Item #	Mfg. #	Description	Cs Wt
A. 380162	975B	Oval, 9" x 6" x 2½"	1.50 lb
B. 380161	917B	Oblong, 9" x 4" x 2"	1.25 lb

Sold in case pack only.



A LA CARTE BASKET

- Dishwasher, microwave and heat lamp safe
- Black polypropylene
- 8½" x 6" x 1½"

Item #461877
 Mfg. #1073BK
 Cs Pk 1 x 3 dz
 Cs Wt 5.00 lb
Sold in case pack only.

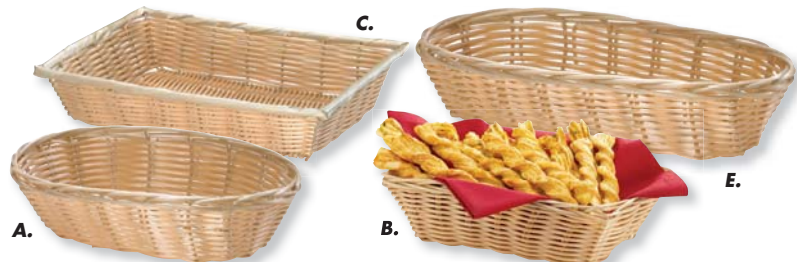

HANDWOVEN BASKETS

- Polypropylene cord
- Easy clean-up with damp cloth
- Won't absorb oil or odors
- Polybagged

Item #	Mfg. #	Description	Cs Pk	Cs Wt
A. 380158	1174W	Oval, 9" x 6" x 2¼"	1 x 1 dz	2.25 lb
380160	1176W	Oval, 10" x 6½" x 3"	1 x 1 dz	2.75 lb
B. 380157	1172W	Rectangular, 9" x 6" x 2½"	1 x 1 dz	2.86 lb
C. 407396	1188W	Rectangular, 14" x 10" x 3"	1 x 6 ea	3.38 lb
465333	1189W	Rectangular, 16" x 11¼" x 3"	1 x 6 ea	4.13 lb
D. 380159	1175W	Round, 8½" x 2¼"	1 x 1 dz	2.58 lb
E. 380156	1117W	Oblong, 9" x 3½" x 2"	1 x 1 dz	1.70 lb

Sold in case pack only.



HANDWOVEN BASKET

- Natural bamboo
- Easy clean-up with damp cloth
- Oval, 8½" x 7¼" x 3"

Item #393437
 Mfg. #1274N
 Cs Pk 1 x 1 dz
 Cs Wt 1.60 lb
Sold in case pack only.



ARTISAN COLLECTION™

- Black powder coated metal
- Cs Pk 1 x 6 ea

Item #	Mfg. #	Description	Cs Wt
A. 482799	BK17409	Oval, 9" x 6" x 2¼"	5.00 lb
B. 482798	BK17410	Oval, 10" x 7" x 3¼"	5.50 lb
C. 482803	BK17508	Round, 8" x 2"	4.50 lb
D. 482802	BK17209	Rectangular, 9" x 6" x 2½"	5.25 lb

Sold in case pack only.

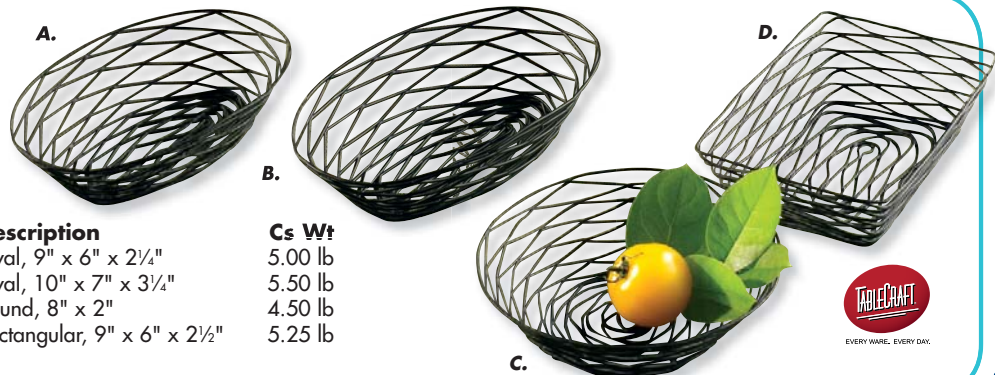



OVAL BASKETS

- Polyethylene
- Safe for use under heat lamps
- Stackable
- Dishwasher and microwave safe
- 9 3/8" x 6" x 1 7/8"
- Cs Pk 1 x 3 dz
- Cs Wt 4.00 lb



Item #	Mfg. #	Color
380148	1074BK	Black
380150	1074R	Red
380147	1074BR	Brown
380149	1074FG	Forest Green
380151	1074Y	Yellow
393111	1074G	Green

Sold in case pack only.

GRANDE PLATTER BASKETS

- Polypropylene
- Dishwasher, microwave and heat lamp safe
- Rectangular, 10 3/4" x 7 3/4" x 1 1/2"
- Cs Pk 1 x 3 dz
- Cs Wt 6.00 lb



Item #	Mfg. #	Color
391264	1077BK	Black
388493	1077R	Red
391125	1077FG	Forest Green

Sold in case pack only.

MÁS GRANDE PLATTER BASKETS

- Polypropylene
- Dishwasher, microwave and heat lamp safe
- Rectangular, 11 3/4" x 8 1/2" x 1 1/2"
- Cs Pk 1 x 3 dz
- Cs Wt 7.00 lb



Item #	Mfg. #	Color
391350	1079BK	Black
389134	1079R	Red
395328	1079FG	Forest Green

Sold in case pack only.



MULTI-TASKING BASKETS

- Ready to serve anything from wings, hot dogs, breads and sandwiches to complete meals
- Dishwasher safe polypropylene



Item #	Mfg. #	Description	Cs Pk	Cs Wt
A. 531264	OB-938-R	Oval, 9 1/2" x 6", Red	1 x 3 dz	5.00 lb
Textured Basket w/Base				
B. 528115	RB-892-BK	Round, 9", Black	1 x 1 dz	5.00 lb
528114	RB-880-BK	Round, 10 1/2", Black	1 x 1 dz	7.00 lb

Sold in case pack only.

WEAVEWEAR™ BASKET

- Wicker weave pattern exterior with smooth, easy-to-clean interior
- For serving chips, fries, sandwiches, finger foods, or kids meals
- Safe alternative to wicker and plastic coated wire
- Round, 12" dia
- Black polypropylene



Item #443326
 Mfg. #652603
 Cs Pk 1 x 1 dz
 Cs Wt 8.00 lb
Sold in case pack only.



JUMBO BASKETS

- Polypropylene
- Stackable
- Dishwasher, microwave and heat lamp safe
- Oval, 11 3/4" x 8 7/8" x 1 7/8"
- Cs Pk 1 x 3 dz
- Cs Wt 6.00 lb

Item #	Mfg. #	Color
380152	1084BK	Black
380155	1084R	Red
380154	1084FG	Forest Green

Sold in case pack only.



SIDE ORDER BASKET

- Dishwasher, microwave and heat lamp safe
- High density polyethylene
- Oval, Red, 7 3/4" x 5 1/2" x 1 7/8"

Item #399371
 Mfg. #1071R
 Cs Pk 1 x 3 dz
 Cs Wt 4.00 lb
Sold in case pack only.



SERVING BASKET

- Dishwasher, microwave and heat lamp safe
- Polyethylene
- Round, Red, 8" dia x 2 3/8" deep

Item #421388
 Mfg. #1075R
 Cs Pk 1 x 3 dz
 Cs Wt 5.00 lb
Sold in case pack only.



TEXAS PLATTER BASKETS

- Polypropylene
- Dishwasher, microwave and heat lamp safe
- Oval, 12 3/4" x 9 1/2" x 1 1/2"
- Cs Pk 1 x 3 dz

Item #	Mfg. #	Color	Cs Wt
432211	1086FG	Forest Green	8.00 lb
436509	1086BK	Black	8.00 lb
391563	1086R	Red	9.00 lb

Sold in case pack only.



CHICAGO PLATTER BASKETS

- Dishwasher, microwave and heat lamp safe
- Polypropylene
- Stackable
- Oval, 10 1/2" x 7" x 1 1/2"
- Cs Pk 1 x 3 dz
- Cs Wt 6.00 lb

Item #	Mfg. #	Color
380143	1076BK	Black
380145	1076R	Red
380142	1076BR	Brown
380144	1076FG	Forest Green
380146	1076Y	Yellow
389533	1076BL	Royal Blue

Sold in case pack only.



NAPKIN DISPENSER

- Stainless steel
- 7 $\frac{3}{8}$ " high

Item #476378

Mfg. #ND-7
Cs Pk 36 x 1 ea
Cs Wt 43.00 lb

Sold in case pack or eaches.**NAPKIN DISPENSER**

- Holds full size napkins
- Stainless steel
- 7 $\frac{1}{2}$ " high

Item #397944

Mfg. #221
Cs Pk 24 x 1 ea
Cs Wt 28.00 lb

Sold in case pack or eaches.**STRAW DISPENSER**

- Glass with chrome plated top
- 11 $\frac{1}{4}$ " high
- Straws not included

Item #480133

Mfg. #714CH
Cs Pk 1 x 6 ea
Cs Wt 16.00 lb

Sold in case pack only.**TOOTHPICK DISPENSER**

- Stainless steel
- Toothpicks not included

Item #423843

Mfg. #236
Cs Pk 1 x 1 ea
Cs Wt 1.58 lb

**ACRYLIC TABLE TENT**

- Two sided
- Clear
- 4" w x 6" h

Item #458158

Mfg. #4060
Cs Pk 24 x 1 ea
Cs Wt 6.00 lb

Sold in case pack or eaches.**TOOTHPICK DISPENSER**

- Sliding top for easy loading
- Holds standard box of toothpicks (not included)
- Security cable prevents theft and breakage
- Clear acrylic

Item #371302

Mfg. #TP10007
Cs Pk 1 x 1 ea
Cs Wt 0.84 lb

**STRAW BOSS® JR. WRAPPED & BULK STRAW DISPENSERS**

- Dispensing mechanism aligns and positions bulk straws for proper dispensing every time
- 4" w x 9" d x 7" h
- Walnut wood grain finish

Wrapped Straw Dispenser

- Single-sided
- Holds 200 straws

Item #380837

Mfg. #3815-12
Cs Pk 1 x 1 ea
Cs Wt 2.00 lb



#3815-12

Bulk Straw Dispenser

- Single-sided
- Holds 250 straws

Item #380822

Mfg. #3825-12
Cs Pk 1 x 1 ea
Cs Wt 2.00 lb



#3825-12

**VENUE™ NAPKIN DISPENSER WITH STAND**

- The best for every venue, every napkin, every operation
- Larger capacity reduces frequency of refills
- High-impact plastic construction
- Transparent cover allows easy monitoring of napkin levels
- Capacity: 600 fullfold napkins
- 8" w x 13" d x 17 $\frac{1}{2}$ " h
- Clear

Item #454684

Mfg. #H5001SCL
Cs Pk 1 x 1 ea
Cs Wt 2.70 lb



#H3001BKC



#H3001CLBK

COUNTERTOP NAPKIN DISPENSERS

- Face: 18 gauge steel or clear polycarbonate plastic
- Cabinet: 20 gauge steel
- Base: High-impact plastic
- Capacity: 300 fullfold napkins
- Attractive two-tone colors
- 7 $\frac{5}{8}$ " w x 11" d x 5 $\frac{1}{2}$ " h



Item #	Mfg. #	Front/Body	Cs Pk	Cs Wt
380926	H3001BKC	Chrome/Black	6 x 1 ea	26.00 lb
380928	H3001CLBK	Clear/Black	6 x 1 ea	23.92 lb

Sold in case pack or eaches.

LID DISPENSER

- Easy access and front-loading
- For two lid sizes, holds ½ sleeve each
- Can be stand or wall mounted
- 22 gauge, 304 stainless steel construction
- Tube length 23½"
- For 6 to 24 oz lids

Item #380935

Mfg. #L3402

Cs Pk 1 x 1 ea

Cs Wt 2.80 lb

SAN JAMAR
Smart → Safe → Sanitary



LID DISPENSER

- Anti-slip feet for countertop use
- Mountable to wall or beverage dispensing head
- 22 gauge, 304 stainless steel construction
- Holds 3 stacks of lids - adjustable dividers
- 14¼" w x 5¼" d x 6½" h

Item #380937

Mfg. #L1014

Cs Pk 1 x 1 ea

Cs Wt 3.20 lb



DISPENSER KIT & STAND

- Chrome plated stand, 304 stainless steel dispensers
- Complete with rotating stand, lid and cup dispensers
- Allows for high volume dispensing in a small footprint
- 12" w x 12" d x 36" h

Item #380934

Mfg. #C3620

Cs Pk 1 x 1 ea

Cs Wt 17.20 lb

SURFACE MOUNT EZ-FIT® DISPENSER

- Made of high-impact plastic
- Unique one-size-fits-all EZ-Fit® dispenser can be mounted under the counter or on the wall
- Includes wire form for hanging and 4 pre-cut gaskets for 8 to 46 oz cups
- 2⅞" to 4¾" dia rim
- Tube length: 23½"

Item #380941

Mfg. #C2410SM

Cs Pk 1 x 1 ea

Cs Wt 4.83 lb

NSF

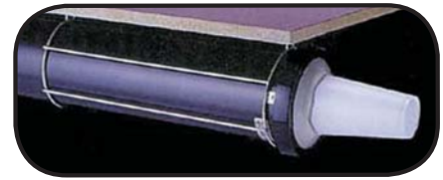

PULL-TYPE FOAM CUP DISPENSER

- 26 gauge, 304 stainless steel
- Approximate cup size is 32-46 oz
- Fits on dispenser stand, top loaded and gravity fed
- 3¼" to 3⅞" rim dia
- Tube length: 23½"

Item #429451

Mfg. #C4400PF

Cs Pk 1 x 1 ea

Cs Wt 16.26 lb

SAN JAMAR
Smart → Safe → Sanitary



EZ-FIT® DISPENSER

- Unique gasket design allows dispensing of paper, plastic or foam cups
- Dispenser comes with 4 pre-cut, easy-to-change gaskets
- Made of high-impact plastic
- Vertical/horizontal mount

One Size Fits All EZ-Fit®

- Includes gaskets for 8 to 46 oz cups
- 2⅞" to 4¾" dia rim
- Tube length: 23¾"

NSF

Item #380940

Mfg. #C2410C

Cs Pk 1 x 1 ea

Cs Wt 3.50 lb

SAN JAMAR
Smart → Safe → Sanitary



#C2410C

PULL-TYPE CUP DISPENSERS

- Patented adjustable collar easily conforms to cup size
- 26 gauge, 304 stainless construction
- Dispenses all cup types
- Top loading, gravity fed
- Tube length: 23½"
- Cs Pk 1 x 1 ea

SAN JAMAR
Smart → Safe → Sanitary

Item #	Mfg. #	Rim Dia	Cs Wt
Cup Size 6 to 10 oz			
380929	C3200P	2⅞" to 3⅞"	3.00 lb
Cup Size 12 to 24 oz			
380930	C3400P	2¾" to 3⅞"	3.50 lb
Cup Size 32 to 46 oz			
380931	C3500P	4" to 4⅞"	4.00 lb



ICE CREAM CONE DISPENSER

- High impact plastic
- Easily mounts onto any wall surface
- Includes 3 gaskets to accommodate: cake, sugar and waffle cones
- Keeps cones fresh
- Protects cones from breaking
- 6" dia x 6½" h

Item #416148

Mfg. #IC2200SM

Cs Pk 1 x 1 ea

Cs Wt 2.92 lb



FAST FOOD TRAYS

- Sturdy and attractive for solid user-friendly service
- Equipped with a unique, textured, slip resistant surface for concealing scratches and delivering your products hassle-free
- Stain and odor resistant
- Dishwasher safe
- Basket weave finish

NSF

#NPL610-00004

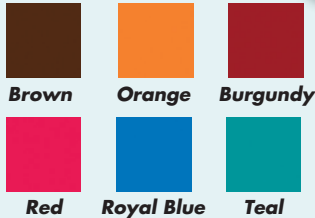
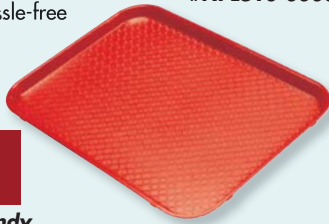

Item #	Mfg. #	Color	Cs Pk	Cs Wt
10" x 14" with Standard Rim				
392735	NPL61000003	Brown	1 x 24 ea	13.50 lb
392743	NPL61000095	Orange	1 x 24 ea	13.50 lb
392746	NPL61000008	Burgundy	1 x 24 ea	13.50 lb
392742	NPL61000004	Red	1 x 24 ea	13.50 lb
392745	NPL61000078	Royal Blue	1 x 24 ea	13.50 lb
392749	NPL61000042	Teal	1 x 24 ea	13.50 lb
12" x 16" with Standard Rim				
396692	NPL61500001	Brown	1 x 24 ea	20.00 lb
396693	NPL61500016	Red	1 x 24 ea	20.00 lb
14" x 18" with Wide Rim				
396694	NPL61800014	Brown	1 x 12 ea	12.50 lb
396695	NPL61800010	Red	1 x 12 ea	12.50 lb

Sold in case pack only.

NON-SLIP POLYTREAD® TRAYS

- Non-skid surface
- Reduce costs, spills and breakage
- Lightweight polypropylene
- Dri-stak separators allow air to circulate over and under each tray for fast drying
- Brown
- Cs Pk 12 x 1 ea



NSF



Item #	Mfg. #	Description	Cs Wt
380102	PT1100-167	11" dia	6.60 lb
380104	PT1400-167	14" dia	10.44 lb
380106	PT1600-167	16" dia	12.88 lb

Sold in case pack or eaches.

CAMTREAD® TRAYS

- Non-skid surface puts a firm grip on your beverage and meal service items
- Less breakage, less spillage and greater profits
- Uniquely built with thick aluminum wire molded into the rim to eliminate warping and cracking
- Guaranteed not to crack, bubble or peel for five years

NSF



Stocked in black and tan only.



Item #	Mfg. #	Description	Cs Pk	Cs Wt
Round				
379874	1400CT-110	14" dia, Black	12 x 1 ea	14.00 lb
379884	1400CT-138	14" dia, Tan	12 x 1 ea	14.00 lb
379907	1600CT-110	16" dia, Black	12 x 1 ea	25.75 lb
380057	1600CT-138	16" dia, Tan	12 x 1 ea	25.75 lb
Oval				
398323	2700CT-110	22" x 26 ⁷ / ₈ ", Black	6 x 1 ea	24.49 lb
380324	2700CT-138	22" x 26 ⁷ / ₈ ", Tan	6 x 1 ea	24.49 lb

Sold in case pack or eaches.

GRIP TRAYS

- Heavy-duty P.P. material
- Non-slip surface
- Black



Item #	Mfg. #	Description	Cs Pk	Cs Wt
482358	GT-1400BK	14", Round	12 x 1 ea	15.00 lb
482359	GTFG-2700BK	22" x 27", Oval	6 x 1 ea	25.00 lb

Sold in case pack or eaches.

FAST FOOD TRAYS

- Textured surface
- Rectangular



Item #	Mfg. #	Description	Cs Pk	Cs Wt
482353	FFT-1216BK	16"w x 12"d, Black	1 x 1 dz	10.00 lb
482354	FFT-1216RD	16"w x 12"d, Red	1 x 1 dz	10.00 lb

Sold in case pack only.

FAST FOOD TRAYS

- Durable with ridged bottom for added strength
- Attractive textured surface helps keep dishes, foods and beverages from slipping

NSF



Item #	Mfg. #	Description	Cs Pk	Cs Wt
368286	1014FF-167	10 ⁷ / ₈ " x 13 ⁵ / ₈ ", Brown	1 x 24 ea	15.84 lb
369818	1014FF-163	10 ⁷ / ₈ " x 13 ⁵ / ₈ ", Red	1 x 24 ea	15.84 lb
369960	1216FF-167	11 ⁷ / ₈ " x 16 ¹ / ₈ ", Brown	1 x 24 ea	21.43 lb
370372	1216FF-163	11 ⁷ / ₈ " x 16 ¹ / ₈ ", Red	1 x 24 ea	21.43 lb
467365	1216FF-416	11 ⁷ / ₈ " x 16 ¹ / ₈ ", Cranberry	1 x 24 ea	21.43 lb
367793	1418FF-167	13 ¹ / ₂ " x 17 ³ / ₄ ", Brown	1 x 12 ea	15.84 lb
369884	1418FF-163	13 ¹ / ₂ " x 17 ³ / ₄ ", Red	1 x 12 ea	15.84 lb

Sold in case pack only.



#1596CW-186

CAMBRO
TRUSTED FOR GENERATIONS™



#915CW-119

CAMWEAR® 2 X 2 COMPARTMENT TRAYS

- Unique design lets you fit 18 trays, side-by-side in a standard dishrack
- Gradual slope on compartment walls promotes faster drying
- "Easy grip" handles ensure a better grip for children with smaller hands
- Made of virtually unbreakable Camwear polycarbonate
- Guaranteed for two years against breakage
- Cs Pk 1 x 24 ea

Item #	Mfg. #	Description	Cs Wt
458925	1596CW-186	9" x 15" x 7/8", Navy Blue	20.64 lb
478505	915CW-119	8 3/4" x 15" x 3/4", Sherwood Green	17.33 lb

Sold in case pack only.



Sherwood Green

Navy Blue

Cranberry

CAMBRO
TRUSTED FOR GENERATIONS™

SCHOOL COMPARTMENT TRAYS

- FDA-approved for food contact
- Five portion compartments and a compartment for silverware
- Perfect for school lunch programs and cafeterias
- Textured surface resists scratching
- 10" x 14 1/2" • Cs Pk 1 x 24 ea

Item #	Mfg. #	Description	Cs Wt
Budget Saver-ABS			
396802	BCT1014-186	Navy Blue	11.10 lb
396805	BCT1014-119	Sherwood Green	11.10 lb
Penny Saver-Co-Polymer			
384352	PS1014-186	Navy Blue	13.73 lb
420465	PS1014-416	Cranberry	13.73 lb

Sold in case pack only.

MAHOGANY TRAY STAND

- Two bottom crossbars for extra sturdiness
- Rubber slip-proof top rings
- One hand operation
- 16 1/2" w x 14 1/2" d, Top 32" h

Item #380352
Mfg. #21
Cs Pk 1 x 1 ea
Cs Wt 10.00 lb



METAL TRAY STANDS

- Chrome plated
- Heavy tubular construction
- Washable, replaceable black webbing

Single Bar
18" w x 16" d Top, 29 1/2" h
Item #397418
Mfg. #23
Cs Pk 6 x 1 ea
Cs Wt 37.00 lb

#23

Double Bar
19" w x 16 1/2" d Top, 31" h
Item #380467
Mfg. #24
Cs Pk 6 x 1 ea
Cs Wt 48.00 lb
Sold in case pack or eaches.



#24



SUPERLEVEL® TABLE GLIDE

- Stops tables from wobbling on uneven floors
- Readjusts to hardwood floors, carpeting or quarry tile
- Fits tables 25 to 140 lb

Item #397392
Mfg. #B14-49
Cs Pk 6 x 1 dz
Cs Wt 3.00 lb
Sold in case pack or dozen.



TRAY STAND

- Environmentally friendly hardwood stand
- Washable black webbing
- 31 1/2" high

Item #537135
Mfg. #TSW-103
Cs Pk 4 x 1 ea
Cs Wt 30.00 lb
Sold in case pack or eaches.



TRAY STAND

- 37" height eliminates stooping and bending caused by shorter stands
- Lightweight polished-chrome design is easy to carry and set up
- Chrome plated

Item #482441
Mfg. TSC-37
Cs Pk 4 x 1 ea
Cs Wt 33.00 lb
Sold in case pack or eaches.





CHROME TRAY STAND

- 31" high
- Item #504949**
- Mfg. #TSY-1A
- Cs Pk 6 x 1 ea
- Cs Wt 41.89 lb
- Sold in case pack or eaches.**



#TR-34W



WOOD TRAY STANDS

- 32" high
- Cs Pk 1 x 1 ea

Item #	Mfg. #	Description	Cs Wt
504997	TR-33W	Walnut	9.48 lb
504998	TR-34W	Mahogany	8.38 lb

Sold in case pack or eaches.

STACKING HI-CHAIRS

- Durable rubberwood
- Ships knocked down
- Cs Pk 1 x 1 ea
- Cs Wt 15.00 lb

Item #	Mfg. #	Description
504992	CHH-103	Mahogany
504993	CHH-104	Walnut
504991	CHH-101	Natural



#CHH-104

#CHH-103
Shown Assembled



#CHH-101



HIGH CHAIRS

- Durable hardwood construction
- Cs Pk 1 x 1 ea

Item #	Mfg. #	Color	Cs Wt
Unassembled			
389081	65	Natural	15.00 lb
389082	66	Walnut	15.00 lb
Assembled			
393180	65A	Natural	21.00 lb
402830	66A	Walnut	21.00 lb
Replacement Strap			
413301	67	Walnut	1.00 lb



EVERY WARE, EVERY DAY.



STACKABLE HIGH CHAIR

- Environmentally friendly plantation hardwood
- Crotch strap and restraint belt included
- Shipped assembled
- Color: Natural
- Cs Pk 1 x 1 ea



Item #	Mfg. #	Description	Cs Wt
528110	HC-100-N-1	High Chair	17.00 lb
528122	STRAPS	Replacement Straps, Brown	1.00 lb

BOOSTER SEATS

- Polyethylene, easy-to-clean, nest for stacking
- High sides, wide square bases and non-skid surface
- Cs Pk 1 x 1 ea

#100BC1-157



TRUSTED FOR GENERATIONS™

#200BC1-131



#100BC1-158



Item #	Mfg. #	Color	Cs Wt
380112	200BC1-131	Dual Height, Brown	4.75 lb
380115	200BC1-158	Dual Height, Red	4.75 lb
380055	100BC1-157	Single Height, Coffee Beige	3.00 lb
379663	100BC1-131	Single Height, Brown	3.00 lb
380616	100BC1-158	Single Height, Red	3.00 lb

CHECK CADDY & SPINDLE

- Brass plated
- Cs Pk 12 x 1 ea



Item #	Mfg. #	Description	Cs Wt
399875	171	Check Caddy	7.00 lb
399874	172	Check Spindle	2.00 lb

Sold in case pack or eaches.



EVERY WARE, EVERY DAY.

TABLE CRUMBER

- Gold anodized aluminum with pocket clip

Item #484284

Mfg. #518
Cs Pk 12 x 1 dz
Cs Wt 1.50 lb

Sold in case pack or dozen.



CHECK HOLDER

- 14 point vinyl with sewn border and "Thank You" imprint
- Two fold, gold stamped
- Order pad not included
- Black
- 5"w x 9"h

Item #484630

Mfg. #59BK
Cs Pk 25 x 1 ea
Cs Wt 9.00 lb

Sold in case pack or eaches.



DINING / TABLE SERVICE

TABLETOP "RESERVED" TENT SIGN

- Silk-screened message appears on both sides
- Durable plastic signs stack to minimize storage space
- 9"w x 3"h sign

Item #380903

Mfg. #4135
Cs Pk 1 x 1 dz
Cs Wt 1.00 lb

Sold in case pack only.



MENU HOLDER

- 18/8 stainless steel
- 2½"w x 1¾"h

Item #525890

Mfg. #92070
Cs Pk 12 x 1 ea
Cs Wt 0.40 lb

Sold in case pack or eaches.



MENU/CARD STAND

- Stainless steel with heavy cast iron base
- 18" high

Item #476371

Mfg. #MCH-18
Cs Pk 12 x 1 ea
Cs Wt 8.00 lb

Sold in case pack or eaches.



TABLE NUMBERS

- Plastic cards
- Numbers 1-100
- 4" x 4"
- Black printed on white

Item #476408

Mfg. #PTN4/1-100
Cs Pk 50 x 1 set
Cs Wt 46.00 lb

Sold in case pack or set.



TABLE BELL

- Loud and sturdy
- Chrome plated
- 3½" black base

Item #476431

Mfg. #TB-35
Cs Pk 12 x 1 ea
Cs Wt 4.13 lb

Sold in case pack or eaches.



MENU HOLDER

- Ring type
- 2½" x 2⅓"

Item #509289

Mfg. #MH-2
Cs Pk 1 x 2 dz
Cs Wt 1.76 lb

Sold in case pack only.



Triple Fold Menu Covers



Single Menu Covers

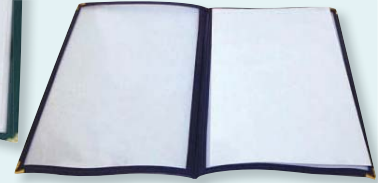

Double Fold Menu Covers

MENU COVERS

- Cs Pk 1 x 25 ea

Item #	Mfg. #	Description	Cs Wt
505005	PMC-5K	Single, 8½" x 5½", Black	18.00 lb
505006	PMC-9K	Single, 12" x 9½", Black	30.80 lb
505008	PMC-9U	Single, 12" x 9½", Burgundy	30.80 lb
505004	PMC-14K	Single, 14" x 8½", Black	19.18 lb
505009	PMCD-9K	Double Fold, 12" x 9½", Black	31.00 lb
505010	PMCD-9U	Double Fold, 12" x 9½", Burgundy	31.00 lb
505011	PMCT-9K	Triple Fold, 12" x 9½", Black	23.15 lb

Sold in case pack only.

SLIDE CHECK RACKS

- Ball-bearing action provides clean look and one-handed sliding action
- Economical aluminum construction
- Cs Pk 3 x 1 ea

Item #	Mfg. #	Length	Cs Pk	Cs Wt
458166	38240A	24"	3 x 1 ea	4.30 lb
458168	38360A	36"	3 x 1 ea	6.70 lb
458172	38480A	48"	3 x 1 ea	8.80 lb

Sold in case pack or eaches.

SLIDE CHECK RACKS

- Aluminum w/glass marbles – one-handed check operation
- Includes mounting screw pack
- Cs Pk 6 x 1 ea



Item #	Mfg. #	Length	Cs Wt
380944	CK6524A	24"l x 2"h x ¾"d	7.00 lb
380945	CK6536A	36"l x 2"h x ¾"d	10.40 lb

Sold in case pack or eaches.

CROWD CONTROL SYSTEM

- Portable post with a 6½' retractable belt
- Black

Item #516749

Mfg. #CGS-38K

Cs Pk 1 x 2 ea

Cs Wt 50.71 lb

Sold in case pack only.



#LED-10



LED SIGNS

- Three flashing patterns
- Dust-proof transport cover
- 14" x 22¾"
- Cs Pk 5 x 1 ea

Item #	Mfg. #	Description	Cs Wt
504863	LED-10	Open	32.50 lb
504864	LED-11	Pizza	23.50 lb

Sold in case pack or eaches.



#LED-11



HOSTESS SIGN

- Attractive packaging with convenient carry handle
- Aluminum frame, steel pole, steel base and PVC signs
- Gold silk screen lettering
- Large 15" display with 15 silk screened messages included: Please Wait To Be Seated, Section Closed, Welcome, Please Register, Smoking Section, Careful...Wet Floor, Section Reserved, Please Seat Yourself, Place Your Order Here, Thank You, Please Come Again, Smoking In Designated Area ONLY Thank You, Please Pay Here, Please Watch Your Step, No Smoking Section, Authorized Personnel Only, Meeting In Progress
- Signs conveniently store within the black frame
- Easy to assemble – no tools required
- 60" height

Item #480921

Mfg. #90033

Cs Pk 2 x 1 ea

Cs Wt 30.00 lb

Sold in case pack or eaches.



#90030

#90031

BLACK & WHITE REVERSIBLE WRITE ON BOARDS

- Weather resistant stainless steel hardware allows for indoor and outdoor usage
- Heavy duty construction
- Durable ⅝" aluminum frame
- Pre-attached hooks allow for vertical or horizontal hanging
- No assembly required
- Includes 5 rainproof fluorescent markers
- Cs Pk 2 x 1 ea

Item #	Mfg. #	Description	Cs Wt
480922	90030	18" x 24" Board	8.69 lb
480923	90031	24" x 36" Board	15.70 lb

Sold in case pack or eaches.

RAINPROOF MARKERS

- Messages will not wash off in the rain
- Accidental touching will not smudge or remove creations
- 5 fluorescent markers will produce a vibrant appearance
- Easily wipes clean with a damp paper towel
- For use with write-on boards, glass or windows
- Colors: Blue, Green, White, Yellow and Pink



Item #480925

Mfg. #90032

Cs Pk 4 x 1 ea

Cs Wt 1.14 lb

Sold in case pack or eaches.





SHELF LINERS

- Durable, designed for bar and kitchen glass areas
- Lie flat and mold to the shape of the surface area
- Mesh pattern allows for thorough drainage
- Provide skid resistance and high impact absorption to minimize glassware breakage
- Improve hygiene by keeping glassware apart from bacteria breeding surfaces
- Cs Pk 1 x 1 ea



Item #	Mfg. #	Description	Cs Wt
UltraLiner® , Matte Finish, Standard			
395905	UL5403	2' x 40', Clear	4.00 lb
395900	UL5405	2' x 40', Black	4.00 lb
Poly-Liner® , Glossy Finish, Economical			
452576	PL0103	2' x 10', Clear	1.87 lb
445403	PL0402	2' x 40', Green	6.49 lb

BAR RAIL MAT

- One piece bar mat and shot glass holder
- 24" length helps eliminate seams
- Easily cleaned in the sink
- Black thermoplastic rubber



Item #531742

Mfg. #CR-753BLK
Cs Pk 12 x 1 ea
Cs Wt 12.60

Sold in case pack or eaches.



TEXLINER BAR & SHELF LINER

- Provide skid-resistance and high impact absorption
- Allow thorough drainage, promoting rapid, fog-free drying – helps prevent bacteria growth
- Resistant to food acids, grease and detergents – conforms to FDA regulations
- Matte finish, lightweight pliable plastic
- 2' x 40' • Color: Black

Item #421541

Mfg. 321003
Cs Pk 1 x 1 ea
Cs Wt 9.50 lb



BAR & SERVICE MATS

- Molded-in pattern provides drainage
- Non-skid knobs built into pattern provide a "sure-grip"
- Bar mats have isolated area for jigger storage, main area holds up to six glasses
- Service mats provide convenient staging area, prevent glasses and bottles from "walking" on wet counters
- Color: Brown



Available in brown only.



Bar Mat: 23"w x 3"d

Item #380776

Mfg. #1060001
Cs Pk 12 x 1 ea
Cs Wt 8.90 lb

Service Mat: 18"w x 12"d

Item #380777

Mfg. #1060101
Cs Pk 6 x 1 ea
Cs Wt 9.70 lb

Sold in case pack or eaches.

BAR SERVICE

FLOW-N-STOW POUR BOTTLE



- Pour bottle comes complete with container, neck and color matched lid and spout
- Go straight from storage to the bar in same bottle
- 1 qt bottle with assorted color on cap/spout
- Colors: Brown, Green, Orange, Red, White and Yellow

Item #482382

Mfg. PBA-10
Cs Pk 1 x 12 ea
Cs Wt 6.70 lb

Sold in case pack only.



Stocked in quart size only.

STORE 'N POUR®



- The essential drink mix system
- Pour a perfect 2-1 drink every time with the exclusive vented spout design
- High density polyethylene containers clean safely, easily and more efficiently
- Prepare mixes and juices in advance for the "busy hours"
- Complete unit includes neck & container plus color-coordinated pouring spout and cap
- Backup unit includes cap and container
- Spout/Cap Assorted Colors: Brown, Green, Orange, Red, Yellow and Clear/White cap
- Assorted half gallon cases include 1 each of above colors
- Assorted pint and quart cases include 2 each of above colors

Item #	Mfg. #	Description	Cs Pk	Cs Wt
414562	PS601N00	Quart Complete, Asst. Colors	12 x 1 ea	4.60 lb
397506	PS603N02	Quart Container, White	12 x 1 ea	3.00 lb
397452	PS701B00	Half-gallon Complete, Asst. Colors	6 x 1 ea	2.90 lb
384423 ▼	PS70200	Half-gallon Backup, Asst. Colors	1 x 6 ea	2.05 lb
388950 ▼	PS103AT00	Spout Only, Asst. Colors	1 x 1 dz	1.00 lb
397775	PS30402	Cap Only, White	12 x 1 ea	0.70 lb
396074 †	PS601200	Bar Service Pack	1 x 1 set	6.95 lb

▼Sold in case pack only. All others sold in case pack or eaches.



† Bar Service Pack contains: six quart complete units (container, neck, and color-coordinated spout and cap); eighteen quart backup units (container and cap); one gallon backup unit (container with cap), for mixing. Spouts and caps in assorted colors.

GLASS RIMMER

- 3 plastic swing-out trays
- Black
- Cs Pk 12 x 1 ea



Item #	Mfg. #	Description	Cs Wt
380469	666	3-Tier Glass Rimmer	15.00 lb
414588	667	Replacement Sponge	0.24 lb

Sold in case pack or eaches.

GLASS RIMMER

- 3 compartment glass rimmer
- Loaded with handy features including compartments for sugar, salt and citrus juices
- Black



Item #482356
Mfg. #GR-3T
Cs Pk 12 x 1 ea
Cs Wt 18.00 lb
Sold in case pack or eaches.

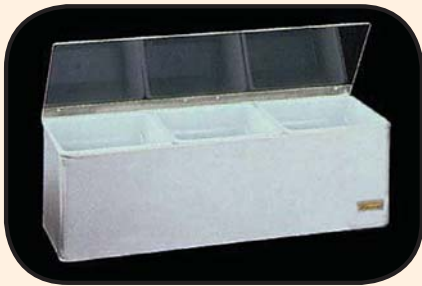

CHILLED CONDIMENT TRAY

- Stainless steel construction with transparent plex lid
- Liner with refreezable ice packs
- 18" w x 5 7/8" d x 5 7/8" h
- Includes 3 one quart inserts, ice liner, EZ-Chill® ice packs and plex lid

Item #380946
Mfg. #B6183L
Cs Pk 1 x 1 ea
Cs Wt 6.50 lb



CONDIMENT TRAY

- Stainless steel with transparent plex lid
- 18 1/8" w x 5 3/4" d x 3 3/4" h
- Includes 6 one-pint inserts

Item #380950
Mfg. #B4186L
Cs Pk 1 x 1 ea
Cs Wt 3.50 lb



CONDIMENT DISPENSER

- Stainless steel
- 5 compartment

Item #482295
Mfg. #CD-5
Cs Pk 12 x 1 ea
Cs Wt 29.50 lb

Sold in case pack or eaches.



THE DOME® GARNISH HOLDERS

- Made of durable plastic w/two handles (included)
- Tailored to fit on standard mixing rails
- Tight dome cover allows overflow of condiments
- Snap-on caddies store picks, sticks and straws
- Black
- Cs Pk 1 x 1 ea



Item #	Mfg. #	Description	Cs Wt
430758	BD4006S	w/6 - 1 pt Trays & 2 - Caddies	4.82 lb
431041	BD4005S	w/1 - 2 qt & 4 - 1 pt trays & 2 - Caddies	3.50 lb
431447	BD4014	w/4 - 1 1/2 pt Trays	4.10 lb

EZ-CHILL® ICE PACK

- Keep your condiments or garnishes chilled without the mess of using ice
- Refreezable - stays cold for up to 5 hours when completely frozen
- 6 ice packs per pack

Item #409266
Mfg. #B6180
Cs Pk 1 x 6 ea
Cs Wt 6.00 lb



Sold in case pack only.



KONDI-KEEPER® CONDIMENT DISPENSERS

- Durable plastic cabinet and lid with one-quart or one-pint inserts
- The extra deep plastic cabinet allows the use of refreezable bottles, ice and/or ice water to keep condiments chilled
- Black, 18" w x 6" d x 6 1/8" h
- Cs Pk 1 x 1 ea
- Cs Wt 4.00 lb

Item # **Mfg. #** **Description**
419730 4742-06 3 qt Containers
425553 4743-06 6 pt Containers





SINGLE SPEED RACK BOTTLE HOLDERS

SAN JAMAR
Smart • Safe • Sanitary

- Made of stainless steel with unique hanger straps
- Holds quarts or liters

Item #380948
Mfg. #B5542
Holds 10 qt./ltr bottles
41 1/4" w x 4 1/8" d x 6" h
Cs Pk 1 x 1 ea
Cs Wt 6.40 lb

Item #380947
Mfg. #B5532
Holds 8 qt./ltr bottles
31 1/8" w x 4 1/8" d x 6" h
Cs Pk 1 x 1 ea
Cs Wt 4.90 lb



BOTTLE HOLDER

- Attractive 3 tier acrylic stand
- Holds 9 bottles

Item #476301
Mfg. #ABO-3X3
Cs Pk 2 x 1 ea
Cs Wt 6.50 lb
Sold in case pack or eaches.



FLAT BOTTLE OPENER

- Stainless steel

Item #482290
Mfg. #BO-7F
Cs Pk 12 x 1 ea
Cs Wt 2.80 lb
Sold in case pack or eaches.



BOTTLE OPENER

- Chrome plated, wall mounted

Item #380487
Mfg. #395
Cs Pk 1 x 1 ea
Cs Wt 0.17 lb



KLEEN-PLUG™ BEER TAP

- Eliminates the time and waste of wrapping beer taps when not in use, as required by health codes
- Helps keep beer taps clean and protected from fruit flies and contamination
- Innovative stepped design fits all tap sizes
- Durable brush removes yeast and sediment for better tasting beer
- Can be chained together for ease of use
- Inner pack of 5

Item #514190
Mfg. #KLP200
Cs Pk 5 x 5 ea
Cs Wt 1.50 lb



Sold in case pack or eaches.

BOTTLE CAP CATCHER

- Stainless steel
- 5 1/2" w x 3 3/8" d x 1 3/8" h

Item #380949
Mfg. #B4300
Cs Pk 1 x 1 ea
Cs Wt 2.10 lb



WINGED CORKSCREW

- Chrome plated metal

Item #380470
Mfg. #1225
Cs Pk 24 x 1 ea
Cs Wt 14.66 lb

Sold in case pack or eaches.



WAITER'S CORKSCREW

- Chrome plated metal
- Plastic handle

Item #425193
Mfg. #1226
Cs Pk 24 x 1 ea
Cs Wt 4.00 lb

Sold in case pack or eaches.



BAR CADDY

- Dishwasher safe ABS plastic
- Black

Item #380468
Mfg. #101
Cs Pk 12 x 1 ea
Cs Wt 15.00 lb

Sold in case pack or eaches.



BAR ORGANIZER

- Six compartments to hold napkins, coasters, straws and stir rods
- Black polystyrene
- 9 1/2" x 5 3/4"
- Made in the USA

Item #531681
Mfg. #CR-1270
Cs Pk 1 x 1 ea
Cs Wt 1.17 lb



ULTIMATE 3 BALL MEASURED POURERS

- Patented design means greater accuracy – more profit
- Advanced design ensures smoother pour with less sticking
- Better construction and materials ensure longer life
- Black collar • Made in the USA
- Cs Pk 1 x 1 dz • Cs Wt 1.00 lb

Item #	Mfg. #	Description
538112	BMP-3100B	1 oz, Blue
538115	BMP-3125G	1¼ oz, Green
538116	BMP-3125R	1¼ oz, Red
538117	BMP-5100B	1 oz, Blue, Flip Top
538118	BMP-5125G	1¼ oz, Green, Flip Top
538120	BMP-5150R	1½ oz, Red, Flip Top

Sold in case pack only.



SCREEN EM™ POURERS

- Black collar
- Plastic free-flow pourer with sanitary screen
- Cs Pk 12 x 1 dz
- Cs Wt 4.00 lb



Item #	Mfg. #	Color
380488	295	Clear Spout
380489	295R	Red Spout
380490	295X	Smoke Spout

Sold in case pack or dozens.



PROPER POUR™ MEASURED POURERS

- Accurate pour for consistent drinks
- Plastic with black collar
- Cs Pk 1 x 1 dz • Cs Wt 0.67 lb



Item #	Mfg. #	Color
523651	2246A	1 oz, Red Dip Tube
530565	2248A	1¼ oz, Clear Dip Tube
530568	2249A	1½ oz, Yellow Dip Tube

Sold in case pack only.

FREE FLOW POURERS

- Plastic - flows freely
- Cs Pk 1 x 1 dz



Item #	Mfg. #	Color	Cs Wt
401029	35R	Economy, Red	0.25 lb
438828	671	Chrome, Black Collar	0.45 lb
530570	1800	Chrome, No Collar	0.42 lb

Sold in case pack only.

WHISKEY POURER

- Plastic – clear spout with black collar

Item #438836
Mfg. #1805
Cs Pk 1 x 1 dz
Cs Wt 0.42 lb



Sold in case pack only.

SHOOTER TUBES & RACK

- Classic S-shaped rack holds (24) 6" tubes (sold separately)
- Easy to fill and disperse tubes
- Fits on standard cocktail trays



Rack – Clear
Item #531740
Mfg. #CR-1600
Cs Pk 1 x 1 ea
Cs Wt 0.29 lb

Tubes – Assorted Neon Colors
Holds .85 oz
Item #538119
Mfg. #CR-1620AC
Cs Pk 1/100 ct
Cs Wt 3.00 lb

Sold in case pack only.



MINI BOMB CUPS

- Shot glass/tumbler for two-part house specialty drinks
- 1 oz inner cup and 2 oz outer cup
- Assorted colors
- Made in the USA

Item #531741
Mfg. #CR-7400AC
Cs Pk 16/25 ea
Cs Wt 32.00 lb

Sold in case pack only.



MUDDLER

- 8" long • Natural wood

Item #483097
Mfg. #4256
Cs Pk 24 x 1 ea
Cs Wt 3.00 lb

Sold in case pack or eaches.



MUDDLER

- Easy to clean – non-porous solid plastic
- Black, ¾" dia
- Made in the USA

Item #531739
Mfg. #CR-1240
Cs Pk 1 x 2 ea
Cs Wt 0.29

Sold in case pack only.



BAR SHAKER

- 3-piece bar shaker
- Stainless steel
- 16 oz

Item #397391

Mfg. #376
Cs Pk 1 x 1 ea
Cs Wt 0.51 lb



BAR SHAKERS

- Stainless steel
- Cs Pk 12 x 1 ea



Item #	Mfg. #	Description	Cs Wt
380474	76	16 oz, 4½" h	4.25 lb
380475	77	28 oz, 7" h	5.17 lb

Sold in case pack or eaches.

COCKTAIL SHAKER

- Stainless steel with mirror polish
- 26 oz

Item #482297

Mfg. #CTS-26
Cs Pk 12 x 1 ea
Cs Wt 5.35 lb

Sold in case pack or eaches.



MALT CUP

- Stainless steel with mirror polish
- 30 oz

Item #484781

Mfg. #MC-30
Cs Pk 12 x 1 ea
Cs Wt 6.50 lb

Sold in case pack or eaches.



JIGGERS

- Stainless steel with dual measure design
- Features jigger on each end

Item #	Mfg. #	Shot Sizes	Cs Pk	Cs Wt
482366	J1-1	½ - 1 oz	12 x 1 ea	0.75 lb
476363	J1-2	¾ - 1¼ oz	12 x 1 ea	1.05 lb
476365	J1-3	¾ - 1½ oz	12 x 1 ea	1.13 lb
476366	J1-5	1 - 1½ oz	12 x 1 ea	1.45 lb

Sold in case pack or eaches.



BAR SPOON

- Stainless steel with red tip
- 11" long

Item #482291

Mfg. #BSP-11
Cs Pk 12 x 1 ea
Cs Wt 0.79 lb

Sold in case pack or eaches.



BAR STRAINER

- 4 prong
- Item #482292**
Mfg. #BST-4
Cs Pk 12 x 1 ea
Cs Wt 1.63 lb
- Sold in case pack or eaches.**



BAR SPOON

- Stainless steel
- 11" long, red knob, twisted handle

Item #380485

Mfg. #501K
Cs Pk 12 x 1 ea
Cs Wt 0.98 lb

Sold in case pack or eaches.



BAR STRAINER

- Stainless steel
- 4 prong

Item #380486

Mfg. #S209
Cs Pk 12 x 1 ea
Cs Wt 1.65 lb

Sold in case pack or eaches.



LIME SQUEEZER

- Stainless steel

Item #380476

Mfg. #95
Cs Pk 1 x 1 ea
Cs Wt 0.29 lb



ICE CHIPPER

- Wood handle
- 6 tips
- Hardened steel points

Item #380479

Mfg. #517
Cs Pk 12 x 1 ea
Cs Wt 3.84 lb

Sold in case pack or eaches.



ICE TONGS

- 6" long, stainless steel

Item #380473

Mfg. #526T
Cs Pk 12 x 1 ea
Cs Wt 0.92 lb

Sold in case pack or eaches.



ICE SCOOP

- Durable stainless steel
- 9" long

Item #380477

Mfg. #512
Cs Pk 12 x 1 ea
Cs Wt 2.41 lb

Sold in case pack or eaches.



BAR SCOOP

- Stainless steel
- 9½" long

Item #482458

Mfg. #BS-9
Cs Pk 12 x 1 ea
Cs Wt 2.50 lb

Sold in case pack or eaches.





ALUMINUM SCOOPS

• Cs Pk 12 x 1 ea



Item #	Mfg. #	Description	Cs Wt
380480	605	5 oz	2.46 lb
380481	612	12 oz	3.98 lb
380482	624	24 oz	6.26 lb
380483	658	58 oz	13.32 lb

Sold in case pack or eaches.

SAFE-T-SCOOP® & GUARDIAN SYSTEM™

- The first food-safety scoop and protection system
- Scoop design prevents hand contact with ice or other foods during use
- Guardian isolates the scoop from the ice or other foods preventing contamination
- Easy mounting options, inside or outside
- Commercial dishwasher safe
- System includes:
 - (1) Saf-T-Scoop (6-10 oz),
 - (1) Guardian Holder,
 - (1) Set Mounting Tools



Item #	Mfg. #	Description	Cs Pk	Cs Wt
430371	SI5000	Scoop Guardian System	1 x 1 ea	1.50 lb
430369	SI5500	Scoop Only	12 x 1 ea	0.50 lb

Sold in case pack or eaches.



SAF-T-ICE® TOTES

- Allows you to transport ice safely, helping you avoid a potential ice-contamination disaster
- Durable, dishwasher safe and unable to nest
- Tri-Grip™ feature provides grab points for secure pouring at any level
- Tougher Handi-Hook™ hangs tote upside down on wire shelving or hanging bracket
- HACCP Hanger™ makes filling totes faster, safer and easier
- Clear Blue • Cs Pk 2 x 1 ea

Item #	Mfg. #	Description	Cs Wt
395927	SI6000	6 gallon	6.00 lb
537492	SI6100	Shorty, 5 gallon	5.00 lb

Sold in case pack or eaches.



SLIDINGLID™ ICE CADDY

- Polyethylene body and thick foam insulation provide durability and long lasting ice storage
- Unique sliding lid helps reduce the risk of cross contamination
- Recessed well and drain shelf keep ice out of water, extends holding time
- Recessed handle on front end for easy moving or lifting
- 22½" w x 30¼" d x 28¾" h, 100 lb capacity
- 2 fixed and 2 swivel casters, 1 with brake
- Color: Dark Brown



Item #532102*
Mfg. #ICS100L-131
Cs Pk 1 x 1 ea
Cs Wt 53.00 lb
*** Special Order**



Not Available via FedEx®.

UTILITY PAIL

- Stainless steel with handle
- Tapered and dent resistant
- Resists corrosion and tarnishing
- 13 qt/12.4 lt

Item #476433
Mfg. #UP-13
Cs Pk 12 x 1 ea
Cs Wt 16.00 lb

Sold in case pack or eaches.



WINE COOLER

- Clear acrylic w/silver band • 4½" dia, 9¼" h

Item #476434
Mfg. #WC-AC
Cs Pk 12 x 1 ea
Cs Wt 17.64 lb

Sold in case pack or eaches.



WINE BUCKET

- Hammered finish • Stainless steel

Item #459646
Mfg. #5198
Cs Pk 6 x 1 ea
Cs Wt 15.00 lb

Sold in case pack or eaches.



WINE BUCKET

- 8 qt capacity
- Stainless steel with 2 gold plated knobs
- Mirror finish

Item #380471
Mfg. #5189
Cs Pk 6 x 1 ea
Cs Wt 12.75 lb

Sold in case pack or eaches.



WINE BUCKET STAND

- Chrome plated
- Folds flat to save space
- Fits Mfg. #5189 wine bucket

Item #380472
Mfg. #5388
Cs Pk 6 x 1 ea
Cs Wt 36.00 lb

Sold in case pack or eaches.



WINE BUCKET & STAND

#WB-4HV

Bucket

4 qt, Mirrored Finish

Item #504951

Mfg. #WB-4HV

Cs Pk 12 x 1 ea

Cs Wt 24.12 lb

Sold in case pack or eaches.

Stand

Pipe-Style, 28½" h

Item #504950

Mfg. #WB-29S

Cs Pk 6 x 1 ea

Cs Wt 37.98 lb

Sold in case pack or eaches.



#WB-29S

BAR SERVICE



DOUBLE WALL WINE COOLER

- Stainless steel
- 4½" dia x 8¾" h

Item #504953

Mfg. #WC-5

Cs Pk 6 x 1 ea

Cs Wt 11.25 lb

Sold in case pack or eaches.



BEEHIVE WINE/CHAMPAGNE BUCKET

- Heavy gauge stainless steel is resistant to corrosion, pitting and rusting
- Mirror-finished exterior for an upscale look
- Satin finished interior for durability
- Dishwasher safe

Item #431510

Mfg. #46609

Cs Pk 1 x 1 ea

Cs Wt 2.58 lb



Setting the Standard™



#789

#795

#97001

#97000

DECANTERS

- Cs Pk 1 x 1 dz

Item #	Mfg. #	Description	Cs Wt
370193	789	½ Liter	10.00 lb
370324	795	1 Liter	17.00 lb
369479	97001	Wine, ½ Liter	13.00 lb
368680	97000	Wine, 1 Liter	21.00 lb

Sold in case pack only.



CARAFES

- Sure Guard™ Guarantee
- Cs Pk 1 x 1 dz

#121UR

#139UR



Item #	Mfg. #	Description	Cs Wt
379035	121UR	½ Liter	14.00 lb
379037	139UR	1 Liter	25.00 lb



CAMWEAR® CAMLITER BEVERAGE DECANTERS

- Made of polycarbonate – won't chip or break
- White spill-proof lid is included
- Allows you to fill and store beverages in off hours
- Cs Pk 1 x 1 dz



Item #	Mfg. #	Description	Cs Wt
368030	WW1000CW-135	1 Liter, Clear	7.00 lb
367969	WW500CW-135	½ Liter, Clear	4.25 lb

Sold in case pack only.

SAFETY ASHTRAY

- Safety island reduces burn marks on bars and tables
- Will not blister or scorch
- Black phenolic plastic
- 7" dia x 1½" d

Item #380494

Mfg. #341B-1

Cs Pk 1 x 1 dz

Cs Wt 4.62 lb

Sold in case pack only.



METAL ASHTRAY

- Economical
- Gold anodized aluminum
- 5¾" dia

Item #380495

Mfg. #575

Cs Pk 1 x 6 dz

Cs Wt 12.00 lb

Sold in case pack only.



EVERY WARE, EVERY DAY.



ASHTRAYS

- Classic deep well will not blister or scorch
- In black phenolic or red melamine plastic
- 4¼" dia x 1¾" d



Item #	Mfg. #	Color	Cs Pk	Cs Wt
380491	263B-1	Black	1 x 1 dz	2.12 lb
380492	265R-1	Red	1 x 1 dz	2.12 lb
Cash & Carry				
423838	C263B-1	Black	6 x 1 dz	14.00 lb

Sold in case pack only.



SANITIZER TABLETS & TEST STRIPS

- Use in kitchen and bar
- Strip dispenser stops wet fingers from damaging unused strips
- Made in the USA



Item #	Mfg. #	Description	Cs Pk	Cs Wt
503904	DIS-202	100 Quaternary Test Strips	12/100 ct	1.00 lb
503903	DIS-302	100 Chlorinated Test Strips	12/100 ct	1.00 lb
503905	DIS-201	150 Quaternary Tablets	6/150 ct	4.00 lb

Sold in case pack only.

LOSUDS® DETERGENT

- Quickly dissolves lipstick and grease leaving glasses to dry spot and film free
- Excellent results in all types of water
- Uses only 1 oz per 3 gal of water
- Easy on hands • Made in the USA

Item # 503902
Mfg. #DET-200
Cs Pk 4/1 gal
Cs Wt 37.00 lb



Sold in case pack only.

DRAIN EXTENSION

- 10" extension fits 1" to 1 1/8" diameter drain
- Non-corrosive plastic
- Made in the USA

Item #531685

Mfg. #CR-701
Cs Pk 1 x 2 pk
Cs Wt 0.25 lb

Sold in case pack only.



MANUAL GLASS WASHERS

- Durable firm-grip suction cup base with replaceable brushes
- Heavy-duty long life brushes – stiffer on top and softer on the sides for better cleaning
- Effortlessly scrubs inside of glassware
- Made in the USA
- Cs Pk 1 x 1 ea



Item #	Mfg. #	Description	Cs Wt
503913	GWM-200	2 Brushes, 8" x 7 1/2"	1.00 lb
503912	GWM-300	3 Brushes, 8" x 9 1/2"	1.50 lb



BEER CLEAN® BAR GLASS WASHING SYSTEM

- Sanitizer and mineral solvent work together to provide thoroughly cleaned beer glasses, wine glasses and other glassware
- No odor, aftertaste or residue

Item #	Mfg. #	Description	Cs Pk	Cs Wt
369317	90221	Glass Cleaner - Manual Brush	100/1/2 oz	4.15 lb
369257	90224	Glass Cleaner - Electric Brush	100/1/2 oz	4.15 lb
369268	90223	Sanitizer	100/1/4 oz	2.10 lb

Sold in case pack only.

STAINLESS STEEL FUNNEL

- One-piece 18/10 stainless steel construction with removable strainer
- Dent resistant
- Easy to clean and hangs for easy storage
- 5 3/4" dia

Item #476349
Mfg. #FSV-6S
Cs Pk 12 x 1 ea
Cs Wt 3.90 lb



Sold in case pack or eaches.



ELECTRIC GLASS WASHERS

- Built tougher - five brush glass washers instantly remove even tough soils like lipstick and fruit pulp
- Heavy duty stainless steel construction, frame and bronze bearings
- Wash virtually any shape and size of glassware
- Powerful 1/3 hp motor, 115V
- Cs Pk 1 x 1 ea • Cs Wt 27.00 lb

Item #	Mfg. #	Description
503915	A-200	Upright, 8" base, 12"l x 18"h
503914	SS-100	Submersible, 8" base, 12"l x 12"h

REPLACEMENT BRUSHES FOR GLASS WASHERS

- Brush size is the usable length of the brush
- Made in the USA

Item #	Mfg. #	Description	Cs Pk	Cs Wt
508409	BRS-917	1 (6"), Fits Bar Maid Models A & SS	1 x 1 ct	0.20 lb
Five Brush Replacement Set				
503911	BRS-1722	4 (6"), 1 (7 1/2"), Fits Bar Maid Models A & SS	1 x 5 ct	1.50 lb
503910	BRS-1720SL	4 (6"), 1 (6 3/4"), Fits Bar Maid & Competitors	1 x 5 ct	1.50 lb

Sold in case pack only.



#BRS-917



#BRS-1720SL

JUICE EXTRACTOR W/PULP EJECTION

- Rapidly produces large volumes of rich, pulp-free juice
- 1.3 hp - 2-speed operation
- 13,000 RPM on high, 6,500 on low
- Brushed stainless steel and polycarbonate housing
- Stainless steel extraction basket with die-cast steel hub
- 3" feed chute with easy-to-remove pulp collector
- Dual interlock for safe operation
- Limited one year motor warranty
- 120V, 1000W



Item #459663*

Mfg. #WJX50

Cs Pk 1 x 1 ea

Cs Wt 38.40 lb

* **Special Order**



MANUAL CITRUS JUICER

- Designed to extract pure citrus juices from oranges, lemons, limes and grapefruits
- Acid-resistant enamel and chrome finish
- Rack and pinion gearing give 2000 lb pressure
- Maximum juice extraction/minimum pulp and skin oil
- Swing-out juice collector cup
- Removable strainer cone and funnel
- Sure Grip™ feet



Item #381277

Mfg. #932

Cs Pk 1 x 1 ea

Cs Wt 11.00 lb



JUICER

- Our 20½" Pro-Restaurant juicer features a stainless steel cup and strainer, smooth tapered auto-lift handle, sure-grip rubber feet and a new narrower footprint
- Zinc alloy

Item #482381

Mfg. #MJHD-21N

Cs Pk 4 x 1 ea

Cs Wt 55.00 lb

Sold in case pack or eaches.



JUICE EXTRACTOR

- Efficiently converts fruits and vegetables into pulp-free juice
- Stainless steel precision balanced basket, bowl and cover
- Polycarbonate motor housing
- 120V



Item #379413

Mfg. #6001C

Cs Pk 1 x 1 ea

Cs Wt 13.60 lb



CITRUS JUICER

- Quiet, heavy duty direct drive motor
- Stainless steel juice collector with large spout
- Sturdy polycarbonate motor housing with vibration-dampening feet
- Universal reamer juices all citrus fruits
- Higher RPM motor (1800) for maximum juice yield
- 120V



Item #395001*

Mfg. #JC4000

Cs Pk 1 x 1 ea

Cs Wt 23.00 lb

* **Special Order**



SPINDLE DRINK MIXERS

- Twice as fast with more powerful ½ hp motors
- Blends milk shakes, smoothies, eggs, batters, ice cream drinks and more...
- Soft-serve 15 seconds, hard ice cream 30 seconds
- 3 speeds plus pulse switch
- Stainless steel agitator and cup
- Heavy duty die-cast construction
- Automatic motor activation
- Sure Grip™ feet • 120V



Single

- 120 servings max. output per hour

Item #469723

Mfg. #HMD200

Cs Pk 1 x 1 ea

Cs Wt 14.00 lb



Triple

- 360 servings max. output per hour
- Three separate ½ hp motors operate independently

Item #469724

Mfg. #HMD400

Cs Pk 1 x 1 ea

Cs Wt 37.00 lb

SINGLE SPINDLE DRINK MIXER

- Agitator quickly mixes ice cream or yogurt shakes, thick drinks or other soda fountain drinks
- Heavy duty 2 speed motor in shock resistant rubber mounts for quiet, dependable operation
- Exclusive removable all stainless steel front panel for easy cleaning
- Heavy duty die cast housing with baked enamel finish
- Fully automatic start-stop operation
- Lubricated-for-life ball bearings
- 120V

Item #379343

Mfg. #DMC20
Cs Pk 1 x 1 ea
Cs Wt 11.60 lb



PORTION BLENDING SYSTEM®

- Bin holds 5 gal of ice cubes and keeps ice from solidifying
- Dispenses the exact amount of ice automatically into blender container by weight
- Blender Motor - ≈ 2 peak hp, Shaver Motor - ¼ hp permanent magnet motor
- Easy to operate
- Safe - shaver will not run unless cover is in place
- Stainless steel enclosed blade assembly with sealed ball bearings
- 64 oz Clear, high-impact container
- Limited one year warranty
- 120V

Item #422286*

Mfg. #1502
Cs Pk 1 x 1 ea
Cs Wt 61.00 lb

* Special Order



MIX'N MACHINE® ADVANCE FROZEN TREAT MIXER

- Fully programmable (software available)
- Pre-programmed with 6 blending programs
- 10 removable/reusable agitators
- Automatic shut-off
- Red LED end-of-cycle indicator light
- Cup-activated actuator lever with "smart delay between cycles"
- Versatile pulse control
- Easy-to-remove protective splash guard
- Enclosed stainless steel shell
- 5 year limited warranty
- 10" w x 8¼" d x 24" h
- 120V

Item #537557*

Mfg. #581
Cs Pk 1 x 1 ea
Cs Wt 30.00 lb

* Special Order



BLENDING STATION® ADVANCE®

- In-counter model
- ≈3 peak hp motor for unmatched performance on the toughest blends
- 93 speeds, a variable speed control and automatic shut-off provide the ultimate in blending flexibility
- 34 optimized programs provide consistent results
- 48 oz high-impact, clear/stackable Advance® container, complete with Advance blade assembly, lid and removable compact cover
- 3 year limited warranty • Made in the USA
- 120V

Item #537559*

Mfg. #40010
Cs Pk 1 x 1 ea
Cs Wt 18.00 lb

* Special Order





#90062

WHIPPED CREAM DISPENSERS

- Stainless steel construction
- Easy to operate
- Dishwasher safe
- Charger sold separately
- For professional use only
- Limited lifetime warranty
- Cs Pk 6 x 1 ea



#90063



Item #	Mfg. #	Description	Cs Wt
537847	90062	1 Pint (0.5L)	15.00 lb
537848	90063	2 Pint (1.0L)	20.00 lb

Sold in case pack or eaches.

WHIPPED CREAM CHARGER

- 10 chargers per box

Item #537846

Mfg. #90060
Cs Pk 36/10 ct
Cs Wt 25.00 lb
Sold in case pack only.



#HBB250



#HBB250S

RIO® BAR BLENDERS

- Wave-Action™ System has unique blade action for smooth drinks - no ice chunks
- 20 second daiquiri
- 2 speed with separate on/off/pulse and high/low switches
- Stainless steel blades
- Sure Grip™ feet
- 120V
- ½ hp motor
- 2 year warranty
- Cs Pk 1 x 1 ea
- Cs Wt 8.50 lb



Item #	Mfg. #	Description
458212	HBB250S	32 oz Stainless Steel Container
458207	HBB250	44 oz Polycarbonate Container

EQUIPMENT

TANGO™ BAR BLENDER

- Performance: Wave-Action™ System continually forces mixture into the blades
- Blends a 16 oz daiquiri in 15 seconds
- 1 hp motor provides ample power and torque
- All-metal drive coupling is built to last
- Timer automatically turns blender off after a preset time
- Timer and two speeds with pulse option
- Stainless steel blades
- 48 oz stackable polycarbonate container
- Sure Grip™ feet and blade assembly unit
- 2 year parts and labor warranty
- 120V



Item #460645

Mfg. #HBH450
Cs Pk 1 x 1 ea
Cs Wt 11.60 lb



908™ BAR BLENDER

- Ideal for frozen cocktails, ice cream drinks, margaritas, iced cappuccinos, granitas, and more...
- ¾ hp motor
- Two speed
- Stainless steel blades
- 44 oz polycarbonate container
- Sure Grip™ feet
- 1 year warranty
- 120V



Item #458206

Mfg. #HBB908
Cs Pk 1 x 1 ea
Cs Wt 5.50 lb



BLENDER REPAIR KIT

- 98908 includes - cutting assembly, clutch and gasket
- Fits 901, 908, 909, 910, 918 & 919,

Item #485384

Mfg. #98908
Cs Pk 1 x 1 ea
Cs Wt 0.32 lb



REPLACEMENT CONTAINER

- 44 oz polycarbonate container
- Fits HBB908
- Includes complete cutting assembly and cover



Item #477558

Mfg. #6126-HBB908
Cs Pk 1 x 1 ea
Cs Wt 1.80 lb



NUBLEND® COMMERCIAL BLENDERS

- Powerful ¾ hp motor
- Crushes ice in seconds!
- Removable, 2-piece jar lid
- High, low, off and pulse toggle switches
- 2 year limited warranty
- 120V
- Cs Pk 1 x 1 ea
- Cs Wt 8.00 lb



#BB180

Item #	Mfg. #	Description
484327	BB180S	32 oz Stainless Steel Container
416580	BB180	44 oz Polycarbonate Container

#BB180S



#BB150S



#BB150



BAR BLENDERS

- Exclusive one piece 4-cutter stainless steel blade for longer life
- Rubber-to-metal drive coupling for maximum durability
- Sturdy rubber feet prevent blender from slipping on wet surfaces
- Heavy duty die cast motor housing for maximum motor protection
- ½ hp, 2-speed motor • 120V • 2 year limited warranty
- Cs Pk 1 x 1 ea

Item #	Mfg. #	Description	Cs Wt
379320	BB150S	32 oz Stainless Steel Container	8.00 lb
379317	BB150	48 oz Polycarbonate Container	7.00 lb



REPLACEMENT CONTAINER

- Clear, unbreakable 48 oz polycarbonate container w/lid and blades
- Fits half-gallon blenders

Item #383503
Mfg. #CAC21
Cs Pk 1 x 1 ea
Cs Wt 2.40 lb



HEAVY DUTY XTREME BLENDER

- Great for smoothies, bar drinks, soups, salsas, sauces, desserts and dressings
- 64 oz polycarbonate container
- 3-speed (Hi-Lo-Pulse), 3½ hp, heavy duty motor
- One piece dishwasher-safe removable jar pad
- Limited 3 year motor, two year parts and labor warranty • 120V

Item #519631
Mfg. #MX1000XT
Cs Pk 1 x 1 ea
Cs Wt 15.00 lb



EQUIPMENT



XTREME HI-POWER BLENDER

- Heavy-duty 3½ peak input hp motor – 45,000 RPM
- Great for smoothies, bar drinks, soups, salsas, sauces, desserts, dressings and more
- The Raptor™ 64 oz BPA-free copolyester container
- One-piece dishwasher safe removable jar pad
- Sound enclosures available for quiet operation
- Simple High, Low, Off and Pulse paddle switches
- Limited 3 year motor and 2 year parts and labor • 120V

Item #537851*
Mfg. #MX1000XTX
Cs Pk 1 x 1 ea
Cs Wt 15.00 lb



* Special Order

BARBOSS® BAR BLENDER



- Blends smoothies, bar drinks, milkshakes, whole fruit and vegetable drinks, frozen coffee/tea – every time
- Automatic shut-off and electronic acceleration control
- Ice blade crushes a half gallon of cubed ice in three seconds
- Stainless steel enclosed blade assembly with sealed ball bearings
- 48 oz clear, high-impact container
- ≈ 2 peak hp motor, 120V
- 3 year limited warranty

Item #422301
Mfg. #5029
Cs Pk 1 x 1 ea
Cs Wt 13.00 lb



VITA-PREP® BLENDER

- Variable speed control allows you to puree, blend, chop, grind, and emulsify
- Acceleration tool for easy processing of dense ingredients
- Handles spices, grains, vegetables and meat
- 64 oz clear, high-impact container
- ≈ 2 peak hp motor, 120V
- 3 year limited warranty

Item #422305
Mfg.# 1002
Cs Pk 1 x 1 ea
Cs Wt 13.00 lb



DRINK MACHINE 2-STEP TIMER BLENDER

- Designed for high impact and heavy use
- Set timer and walk away to serve other guests while blending
- Stainless steel enclosed blade assembly with sealed ball bearings
- 64 oz clear, high-impact container
- 2-step timer, two speeds
- ≈ 2 peak hp motor, 120V
- 3 year limited warranty

Item #422291
Mfg. #1230
Cs Pk 1 x 1 ea
Cs Wt 13.00 lb



DRINK MACHINE TWO-SPEED BLENDER

- Blends smoothies, bar drinks, milkshakes, whole fruit and vegetable drinks, frozen coffee/tea – every time
- Perfect for frozen and ice cream drinks
- Ease of use, blend on high or low or switch from one to another manually
- Stainless steel enclosed blade assembly with sealed ball bearings
- 64 oz clear, high-impact container allows blending of 4 oz to 64 oz
- 2-speed, ≈ 2 peak hp motor, 120V
- 3 year limited warranty

Item #422294
Mfg. #748
Cs Pk 1 x 1 ea
Cs Wt 15.00 lb



Additional containers available – See blender accessories below

BLENDER ACCESSORIES

- Containers, drive socket kits and ice blade assembly
- Cs Pk 1 x 1 ea



Item #	Mfg. #	Description	Cs Wt
Fits #5029, #748, #1230 and #1502 blenders			
422324	15506	48 oz Stackable, Clear, High-impact Container w/Lid & Ice Blade Assembly	2.00 lb
422312	756	64 oz Clear, High-impact Container w/Lid & Ice Blade Assembly	3.20 lb
422321	891	Drive Socket Kit w/1 Driver – Includes Allen Wrench and Instructions	0.13 lb
Fits all standard containers			
433898	1151	Ice Blade Assembly	0.40 lb

#891



#756



COMMERCIAL FOOD BLENDER

- Ideal for heavy duty food preparation such as salsas, purees, soups, dips, sauces, dressings, drinks, and more
- 1 hp motor with all metal drive coupling
- 2 speed with pulse and auto shut off timer
- 64 oz stainless steel container with removable dosing cup
- Two years parts & labor
- 120V

Item #485062
Mfg. #HBF400
Cs Pk 1 x 1 ea
Cs Wt 9.46 lb



COMMERCIAL FOOD BLENDER

- Great for healthcare use with special diets
- Perfect in kitchens for salsa, dips and sauces
- ¾ hp motor • Two speed with pulse feature
- One gallon stainless steel container with two handles for easy pouring
- Lid is equipped with a heavy-duty gasket to prevent spills
- Metal clamps hold lid securely in place
- Removable cutting unit with four surgical steel blades • Two years parts & labor
- 120V

Item #381281
Mfg. #990
Cs Pk 1 x 1 ea
Cs Wt 25.00 lb



ONE-GALLON FOOD BLENDER

- Stainless steel clover-leaf container with 2 handles for easy pouring
- Rubberized lid
- Advance style base is easy to clean and transport
- ¾ hp motor with switch settings OFF/LO/MED/HI/PULSE
- One-year limited warranty
- 120V

Item #414981
Mfg. #CB15
Cs Pk 1 x 1 ea
Cs Wt 38.00 lb



HALF GALLON FOOD BLENDER

- Full 64 oz blending capacity
- Stainless steel container with black polycarbonate motor housing
- 1½ hp two-speed motor
- Two-piece container lid with removable insert to add ingredients while blending
- One-year warranty
- 120V

Item #379355
Mfg. #HGB150
Cs Pk 1 x 1 ea
Cs Wt 14.10 lb



VITAMIX® XL™ FOOD BLENDER

- 1½ gallon real blending capacity, HOT OR COLD, allows for up to twenty-four 8 oz servings in a single batch
- 4.2 peak horsepower, belt-drive motor
- Includes 2 containers – 192 oz with blade and 64 oz with blade
- Variable speed for controlled performance
- High-performance blade design
- Tamper for whole food processing while blending
- Pulse function at any selected speed
- Ergonomically designed Clear container blends hot and cold ingredients
- Lower profile for better space management
- 3 year limited parts/labor warranty, including a 1 year service contract
- Made in the USA
- 8½" wide
- 120V

Item #521214*
Mfg. #5201
Cs Pk 1 x 1 ea
Cs Wt 50.00 lb
*** Special Order**



VITA-PREP® 3 FOOD BLENDER

- The professional chef's power tool
- Variable speed control allows you to chop, grind or blend different ingredients at exactly the right speed
- ~3 peak hp motor has more power to blend extra thick ingredients quickly and smoothly
- Clear, 64 oz high-impact container complete with blade assembly and lid
- Includes a 54 page recipe book
- 3 year limited warranty
- Made in the USA
- 120V

Item #472711*
Mfg. #1005
Cs Pk 1 x 1 ea
Cs Wt 15.00 lb
*** Special Order**





#WSB2W



#WSB60-3



#WSB70

HEAVY-DUTY BIG STIX® IMMERSION BLENDERS

- Sealed stainless steel shaft – easily removable and dishwasher safe
- Heavy duty, high efficiency 1 hp motor
- 750W variable speed motor – adjustment from 5,000 – 18,000 RPM provides full control and consistency
- Lightweight and ergonomic – rubberized comfort grip and 2nd handle allow for safe and controlled operation
- Continuous “On” feature • One-year limited warranty
- 120V • Cs Pk 1 x 1 ea

Item #	Mfg. #	Description	Cs Wt
431457	WSB60-3	16" Shaft, 25 gal capacity	10.00 lb
473402	WSB70-3	21" Shaft, 50 gal capacity	12.00 lb
483643	WSB2W	10" S/S Whisk Attachment	1.00 lb

MEDIUM-DUTY QUIK STIK PLUS™

- ½ hp heavy-duty motor
- 350-watt 2-speed motor
- 10" shaft
- 6 gallon capacity
- Rubberized comfort grip
- All-purpose stainless steel blade
- One-year limited warranty
- 120V

Item #460725
Mfg. #WSB40-3
Cs Pk 1 x 1 ea
Cs Wt 6.50 lb



QUIK STIK® IMMERSION BLENDER

- 2 speed control
- High efficiency motor
- 7" fixed shaft
- Lightweight and compact
- All purpose stainless steel blade
- 3 gallon capacity
- One-year limited warranty
- 120V, 60 Hz, 100W

Item #432478
Mfg. #WSB33
Cs Pk 1 x 1 ea
Cs Wt 2.40 lb



CONTINUOUS FEED/BATCH BOWL PROCESSOR

- Heavy-duty 1 hp high performance motor • 3½ quart sealed, clear-view batch bowl
- Sealed S-blade with LiquiLock™ Seal System – blade locks into place for easier, safer pouring
- Easy ON and OFF-PULSE control paddles
- Includes base unit, extra-large feed chute with large and small pushers to reduce prep time, ½" slicing disc, ⅜" shredding disc, ¼" grating disc and detachable stem for discs
- Limited 5 year motor and 2 year parts and labor warranty
- 120V

Item #537850
Mfg. #WFP14SC
Cs Pk 1 x 1 ea
Cs Wt 24.00 lb



BATCH BOWL FOOD PROCESSOR

- Heavy-duty ¾ hp high performance motor
- Sealed clear-view 2½ quart batch bowl – process soups, sauces, marinades and more, without leaks
- Sealed S-blade with LiquiLock™ Seal System – holds liquids in the bowl while processing and keeps the blade in bowl when pouring
- Includes stainless steel serrated S-blade, ⅝" slicing disc, ⅜" shredding disc, ¼" grating disc and detachable disc stem
- Large and small pushers reduce prep time
- Easy ON and PULSE/OFF control paddles
- Limited 5 year motor, 2 year parts and labor warranty
- 120V

Item #536252
Mfg. #WFP11S
Cs Pk 1 x 1 ea
Cs Wt 18.00 lb





COMMERCIAL FOOD PROCESSOR

- Slice, shred, grate, chop, puree and julienne directly in the batch bowl
- Includes large and small food pusher, S-blade and 3 discs (3/32" slicing, 3/16" shredding, 1/4" julienne)
- Continuous feed chute • 2 1/2 qt batch bowl
- Limited 5 year motor, 2 year parts and labor warranty
- 120V, 1 hp motor



Item #434438

Mfg. #FP25C
Cs Pk 1 x 1 ea
Cs Wt 30.60 lb



FOOD PROCESSOR

- Heavy-duty 1 hp high performance motor
- 3 1/2 quart clear-view batch bowl
- Stainless steel serrated "S" blade to chop, grind, purée or mix in batch bowl
- Easy ON and OFF-PULSE control paddles
- Includes base unit, extra-large feed chute with large and small pushers to reduce prep time, 5/32" slicing disc, 5/32" shredding disc, 5/64" grating disc and detachable stem for discs
- Limited 5 year motor and 2 year parts and labor warranty
- 120V

Item #484525

Mfg. #WFP14
Cs Pk 1 x 1 ea
Cs Wt 16.30 lb



EQUIPMENT



PRO PREP® CHOPPER GRINDER

- 3/4 quart capacity
- 2 separate bowl and blade assemblies – one for grinding, one for chopping
- Ingredients can be added through cover while operating
- Hi-speed 3/4 hp induction motor
- Dishwasher safe blades, bowls and covers
- Stackable bowl assembly
- One-year limited warranty
- 120V

Item #381409

Mfg. #WCG75
Cs Pk 1 x 1 ea
Cs Wt 24.20 lb



COMMERCIAL STAND MIXER

- Heavy-duty 1+ hp motor to handle the heaviest mixing tasks
- 7 quart stainless steel bowl with carrying handles
- 12 mixing speeds with soft start for precision mixing
- Pulse function with maximum burst of power
- Tilt-back head for easy removal of attachments
- Full die-cast housing
- Includes chef's whisk, mixing paddle, dough hook and splash guard with feed chute
- Limited 2 year warranty
- 120V

Item #483641

Mfg. #WSM7Q
Cs Pk 1 x 1 ea
Cs Wt 31.00 lb

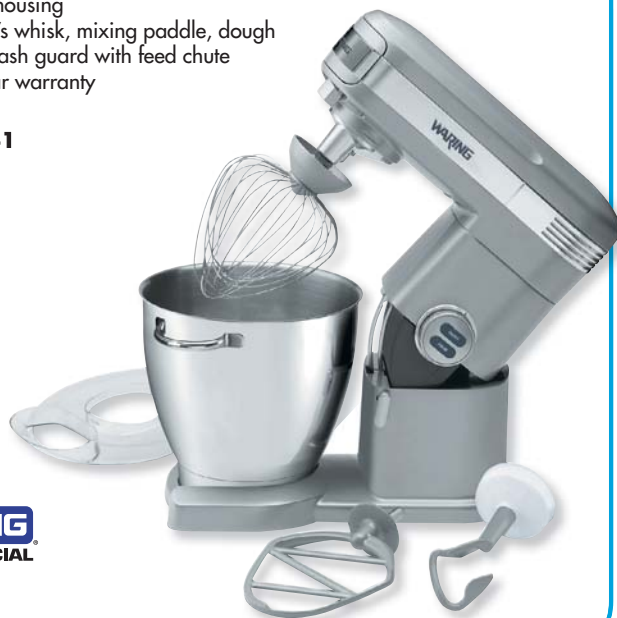

COMMERCIAL STAND MIXER

- 7 quart • 800 watts
- Pop up head
- Maintains speed regardless of load
- Tough all metal gears
- Includes durable, die cast body, stainless steel bowl, spatula, and 3 stainless steel attachments: beater, dough hook and wire whisk
- Variable speed
- Two years parts & labor
- 120V

Item #398201
 Mfg. #CPM700
 Cs Pk 1 x 1 ea
 Cs Wt 23.15 lb



COMMERCIAL COUNTERTOP MIXER

- 10 quart capacity
- Designed specifically for small commercial mixing applications
- Comes standard with mixing bowl, bowl guard, wire whisk, dough hook and spatula
- 110V, 1/3 hp air cooled motor
- 5 speed direct drive transmission
- Non-skid rubber base

Item #530830*
 Mfg. #40756
 Cs Pk 1 x 1 ea
 Cs Wt 51.90 lb
 * Special Order



Setting the Standard™



EQUIPMENT

FLOOR MIXERS

- Come standard with mixing bowl, wire whisk, dough hook and spatula
- 60 quart model includes bowl truck for convenient bowl transport
- Consistent mixing speeds are maintained regardless of the volume in the bowl
- 3 fixed speeds with easy speed shifting
- Gear driven transmission
- Grease packed ball bearing
- Gears and shafts made of heat treated alloy steel
- 2 year parts and 1 year labor warranty, 5 year warranty on belt
- Cs Pk 1 x 1 ea

Item #	Mfg. #	Description	Cs Wt
530832	40757	20 qt, 1/2 hp, 110V	264.00 lb
530807	40760	60 qt, 2 hp, 220V	1035.00 lb



#40757



Setting the Standard™

#40760



Bowl Truck

Items noted with an FOB truck are FOB Factory. Freight charges will be added to all orders placed. Non-returnable items.





INFRARED STRIP HEATERS

- Holds food at serving temperatures without drying out
- Compact, versatile and economical
- Durable aluminum shell for long life and easy cleanup
- Comes with calrod heating element
- 120V • Cs Pk 1 x 1 ea

Item #	Mfg. #	Description	Cs Wt
423088	6150-36	36" Long	11.00 lb
423089	6150-48	48" Long	14.00 lb



HEAT LAMP

- Height adjusts 10"-21"
- 2 bulb heat lamp
- 250 watt white infrared bulbs
- Pan and inset not included
- Grey powder coated finish
- 120V

Item #423083
Mfg. #6000A-2
Cs Pk 1 x 1 ea
Cs Wt 11.00 lb



FLEXIGLOW HEAT LAMP

- Spun aluminum shade with flared rim for added strength
- Perfect for catering or banquet halls, hotels and rental companies
- 39" flexible arm • Includes 250 watt red bulb
- Drilled shade for increased heat dissipation
- Switch located away from the heat source
- Includes NSF listed maple cutting board (16" x 24") and drip pan (18" x 26")
- Cutting board and pan turn heat lamp into a front-of-the-house carving station
- 120V

Item #380750
Mfg. #HL8195B00
Cs Pk 1 x 1 ea
Cs Wt 27.65 lb



ELECTRIC DISPLAY WARMER

- Stainless steel including base
- Designed to keep food warm before serving
- Unbreakable, infrared tubular heating element
- Pans shown not included
- 120V



Item #423119
Mfg. #PD-1A
Cs Pk 1 x 1 ea
Cs Wt 16.00 lb



CARVING STATION

- Combines the heat of a 250 watt infrared bulb with a convenient, functional, USDA high density polyethylene cutting board
- Adjustable, 30" high, flexible gooseneck
- 120V

Item #423095
Mfg. #6015
Cs Pk 1 x 1 ea
Cs Wt 21.00 lb



TWO BULB ADJUSTABLE HEAT LAMP

- Adjustable arm for different heat settings
- Spun aluminum shades with flared rims for added strength and even more heat dissipation
- Ceramic insulated sockets with nickel plated contacts to prevent fusing
- Includes two 250 watt clear bulbs
- On/off switch mounted on arm away from heat zone
- One year warranty against defects in materials and workmanship
- 120V

Item #380747
Mfg. #HL723700
Cs Pk 1 x 1 ea
Cs Wt 9.40 lb



EQUIPMENT

CAYENNE® HEAT 'N SERVE RETHERMALIZERS

- Can take a prepared food from frozen or refrigerated to piping hot, and thermostatically hold the food at proper serving temperature
- Self-insulating thermostat wells – will not crack, pit or rust
- Brushed stainless steel exterior
- 120V, 800 watts • Cs Pk 1 x 1 ea



7 qt unit only
10 7/16" dia x 9 5/8" h
Item #371120
Mfg. #72017
Cs Wt 10.00 lb



11 qt unit only
12 5/8" dia x 9 5/8" h
Item #371055
Mfg. #72021
Cs Wt 11.30 lb

CLASSIC ROUND COOKERS/SERVERS

- Designed to cook and/or hold pre-cooked foods from frozen state
- Thermostatically controlled
- Constructed of stainless steel
- Insets and covers shown sold separately
- Cs Pk 1 x 1 ea



#RCW-11



Item #	Mfg. #	Description	Cs Wt
423108	RCW-7	7 qt, 1000 watt	10.00 lb
423109	RCW-11	11 qt, 1200 watt	12.00 lb



DOUBLE BURNER HOT PLATE

- French burners heat up quickly and evenly
- Six heat settings from simmer to boil
- Stainless steel construction
- Adjustable feet
- 120V

Item #423096
Mfg. #6310-2
Cs Pk 1 x 1 ea
Cs Wt 26.00 lb



CAYENNE® COLONIAL KETTLE™

- Black epoxy-coated aluminum body, recessed controls, unbreakable legs
- Designed to hold heated prepared foods at proper serving temperature
- Includes warmer, 11 qt inset, cover w/hinge, soup cards and soup'r clip
- 15 3/4" dia x 11 1/2" h
- 11 qt capacity
- 120V, 650 watts



Item #379840
Mfg. #72165
Cs Pk 1 x 1 ea
Cs Wt 23.40 lb



COUNTERTOP WARMERS

- Stainless steel construction for durability
- Unique heating element design provides even distribution to prevent hot spots
- Inset, ladle and cover sold separately
- 120V



#6100A

7 Quart
Item #423086
Mfg. #6100A
Cs Pk 1 x 1 ea
Cs Wt 11.00 lb

11 Quart
Item #423087
Mfg. #6101A
Cs Pk 1 x 1 ea
Cs Wt 13.00 lb



ROASTER OVEN

- 18 qt capacity
- Bakes, cooks and serves
- Easy lift-out rack and three buffet pans
- Doubles your oven space
- Household use only



Item #477425
Mfg. #32182
Cs Pk 1 x 1 ea
Cs Wt 23.20 lb



COUNTERTOP WARMER

- Conduction type thermostat
- Unique heating element provides even heat distribution to prevent "hot spots"
- Heavy-duty stainless steel well
- Full size, 14" x 22" x 9"
- Inset not included • 120V



Item #423085
Mfg. #6055A
Cs Pk 1 x 1 ea
Cs Wt 24.00 lb





CLASSIC WARMERS & COOKER/SERVER

- Fully insulated, Robertshaw control, Bi-Met high-limit safety thermostat
- Stainless steel construction
- Can be used in dry or wet applications
- Insets and covers sold separately
- 120V
- Cs Pk 1 x 1 ea

Item #	Mfg. #	Description	Cs Wt
423110	W-3V	Warmer, 22 qt, 12" x 20"	30.00 lb
423112	W-43V	Warmer, 28½ qt, 12" x 27"	30.00 lb
423111	CW-2A	Cooker/Server, 22 qt, 12" x 20"	29.00 lb
423114*	56638	3 Hole Adapter Plate for (3) 7 qt Insets only fits on 12" x 27", W-43V	4.00 lb

CAYENNE® MODEL 2000 WARMER

- 300 series stainless steel 6½" deep well
- Recommend using up to 4" deep food pans – standard and fractional sizes
- Stainless steel exterior for easy cleaning and longer life
- Meets NSF4 standards
- 22" w x 14" l x 8½" h
- 1000 watts • 120V
- Made in the USA

Item #394573
Mfg. #72000
Cs Pk 1 x 1 ea
Cs Wt 19.52 lb



VOLLRATH®
Setting the Standard™

CAYENNE® MODEL 1001 WARMER

- Exclusive Direct Contact Heating System for the most efficient heat transfer
- Self-insulating thermostet well – will not crack, pit or rust
- Black well w/brushed stainless steel housing
- 13¾" w x 21¾" l x 9" h
- 120V, 700 watts
- Made in the USA

Item #368044
Mfg. #71001
Cs Pk 1 x 1 ea
Cs Wt 19.85 lb



VOLLRATH®
Setting the Standard™

BELGIAN WAFFLE BAKER

- Heavy-duty die-cast housing
- Embedded heating elements for precise temperature control
- Rotary feature for even baking and browning
- Audio beep signals when waffle is ready
- Power and ready-to-bake LED indicators
- Nonstick plates allow for easy removal of waffle
- Makes up to (25) 1½" thick Belgian waffles per hour
- 120V

Item #448271
Mfg. #WW150
Cs Pk 1 x 1 ea
Cs Wt 15.40 lb



WARING
COMMERCIAL

EQUIPMENT

DOUBLE BELGIUM WAFFLE MAKER

- Rotary feature for even baking of 2 waffles at one time
- Delivers up to fifty 1½" Belgium waffles per hour
- Embedded heating elements for precise temperature control
- Heavy duty die-cast housing
- Space saving vertical design
- Independent ready lights and audio beep signal when waffles are ready to serve
- Versatile pulse control
- Easy-to-remove protective splash guard
- Enclosed stainless steel shell
- Limited 1 year warranty
- 10.45" w x 17" d x 9.5" h
- 120V, 1400 watts

Item #537849
Mfg. #WW200
Cs Pk 1 x 1 ea
Cs Wt 24.00 lb



WARING
COMMERCIAL

BAGEL TOASTER

- 380 slices per hr
- Four 1½" extra wide slots for bagels
- Bagel slots toast on cut side of bagel only
- 11¾" w x 10½" d x 9" h
- 120V

Item #483640
Mfg. #WCT820
Cs Pk 1 x 1 ea
Cs Wt 22.00 lb



TOASTER

- Chrome-plated steel construction
- Wide slots – 1¾" wide for thicker slices
- 2 long and wide slots for 4 regular size slices or 2 long slices for items like Italian bread
- Convenient touch controls • Pull-out crumb tray
- 18½" w x 8½" d x 8½" h
- 120V

Item #381410
Mfg. #WCT704
Cs Pk 1 x 1 ea
Cs Wt 5.30 lb



COMMERCIAL TOASTERS

- 225 slices per hour
- Brushed chrome steel housing
- Four 1¾" wide slots
- Electronic browning controls
- 12½" w x 7¾" d x 10½" h
- 120V

Item #416578
Mfg. #WCT708-1
Cs Pk 1 x 1 ea
Cs Wt 10.00 lb



- 300 slices per hr
- Four 1¾" wide slots
- Electronic browning controls
- 11¾" w x 10½" d x 9" h
- 120V

Item #431458
Mfg. #WCT800
Cs Pk 1 x 1 ea
Cs Wt 22.00 lb



EQUIPMENT

AT EXPRESS RADIANT CONVEYOR TOASTER

- Front loading, variable speed control, superfeeder
- 1½" product opening
- 10" wide conveyor belt
- Produces over 300 slices per hr
- 14¾" w x 18" d x 13½" h
- 1725W, 120V



Item #423106
Mfg. #AT-EXPRESS
Cs Pk 1 x 1 ea
Cs Wt 35.00 lb



HEAVY-DUTY CONVEYOR TOASTER

- Super high output – 450 slices per hour
- Ultra-fast, 5-minute heat-up time
- Large 2" opening accommodates thick breads and bagels
- Energy-saving standby function
- Heavy-duty, brushed stainless steel construction
- Power On and Toaster Ready indicator lights
- Cool-touch side panels • Compact, space-saving design
- Lightweight and portable with thermo-insulated carrying handles
- Conveyor speed control to suit all toasting preferences
- Limited one year motor warranty • 120V, 1800W

Item #487374
Mfg. #CTS1000
Cs Pk 1 x 1 ea
Cs Wt 46.00 lb



PIZZA OVEN

- Stainless steel
- 14" rack, 15-minute timer, and upper and lower heating elements
- Thermostat preset to 450°F • Crumb tray for easy cleaning
- 19½" w x 20½" d x 7⅞" h • 120V

Item #423091
Mfg. #6215
Cs Pk 1 x 1 ea
Cs Wt 23.00 lb





CAYENNE® PIZZA/BAKE OVEN

- Accommodates 16" pizzas
- Stainless steel exterior and interior for durability and easy cleaning
- Oven supplied with two ceramic bake decks for crisp, even browning of crust and breads
- 2 ceramic bake decks • 15 minute timer function
- Heat setting: 140° to 750°F • 2½" between shelves
- 23⅞" w x 25⅜" d x 18⅞" h • 2100-2800 watts, 208V-240V

Item #530839
Mfg. #40848
Cs Pk 1 x 1 ea
Cs Wt 90.00 lb



CAYENNE® CHEESE MELTER

- Ideal for melting cheese and warming pizza and breads
- Three shelf heights allow use with different size foods and controls distance of food from heating elements
- Slide-out crumb tray for easy cleaning
- Back can be removed for use as pass-thru
- Infinite control • 28⅞" w x 13½" d x 17⅞" h
- 208/240V, 2253/3000W

Item #537554*
Mfg. #40700
Cs Pk 1 x 1 ea
Cs Wt 37.00 lb
*** Special Order**



Not Available via FedEx®.



PIZZA DISPLAY CASE

- Rotating, 3-tier case with 18" racks
- Ideal for holding and displaying pizzas and sandwiches
- stainless steel with tempered glass construction
- Lighted interior and attractive signage
- 22¼" w x 22¼" d x 33⅞" h
- 120V

Item #423276
Mfg. #6451
Cs Pk 1 x 1 ea
Cs Wt 93.00 lb



Not Available via FedEx®.

PRETZEL MERCHANDISER

- Stainless steel cabinet with tempered glass
- Two-tiered rack holds dozens of fresh, toasty pretzels
- 15⅞" w x 18⅞" d x 27¼" h
- Signage included
- 290 watts
- 120V

Item #457673
Mfg. #6403
Cs Pk 1 x 1 ea
Cs Wt 40.00 lb



Not Available via FedEx®.



SLANTED HOT DOG ROLLER GRILLS

- Tiered rollers bring hot dogs into better view
- 10 SilverStone® rollers • 120V
- Individual heating element in each roller



Not Available via FedEx®.



Model shown without SilverStone® coating or slant



- Holds 27 hot dogs
- Cooks 540 - 5" hot dogs per/hr
- 22¼" w x 16¼" d x 10¼" h

Item #476263*
Mfg. #8027S-SLT
Cs Pk 1 x 1 ea
Cs Wt 44.00 lb
*** Special Order**

- Holds 36 hot dogs
- Cooks 720 - 5" hot dogs per/hr
- 29½" w x 16¼" d x 10¼" h

Item #477635*
Mfg. #8036S-SLT
Cs Pk 1 x 1 ea
Cs Wt 55.00 lb
*** Special Order**

STAINLESS STEEL BUN BOXES

- Durable, stackable unit keeps hot dog buns fresh
- Cs Pk 1 x 1 ea



Not Available via FedEx®.



- Holds 36 buns, fits 8027
- 22¼" w x 19" d x 6¼" h

Item #476264*
Mfg. #8027-SBB
Cs Wt 19.00 lb
*** Special Order**

- Holds 48 buns, fits 8036
- 29⅞" w x 19" d x 6¼" h

Item #476266*
Mfg. #8036-SBB
Cs Wt 20.00 lb
*** Special Order**

Items noted with an FOB truck are FOB Factory. Freight charges will be added to all orders placed. Non-returnable items.



EQUIPMENT

MR. FRANK® HOT DOG STEAMER

- Vertical design uses less counter space with no loss of production
- Stainless steel and tempered glass construction
- Holds 150 dogs, 60 plus buns
- 16" w x 14" d x 20½" h
- 120V

Item #423125

Mfg. #DS-1A
Cs Pk 1 x 1 ea
Cs Wt 36.00 lb



MR. FRANK® HOT DOG BROILER & BUN WARMER

- Broil up to 150 franks/hour
- Removable individual cradles make clean-up a snap
- Note: Broiler and bun warmer are UL, NSF and CSA listed as individual components only
- 20" w x 14" d x 24" h • 120V

Item #423126*

Mfg. #DR-2A
Cs Pk 1 x 1 ea
Cs Wt 57.00 lb

* Special Order



HOTROD® ROLLER GRILLS

- Fully adjustable infinite controls and Teflon grease seals
- Tru-Turn non-stick rollers • Grills 510 franks/hr • 120V
- HRS-31 – grills up to 510 franks/hr

Roller Grill, 23¾" wide

Item #423122*

Mfg. #HRS-31
Cs Pk 1 x 1 ea
Cs Wt 42.00 lb

* Special Order



Sneeze Guard, 24¼" w x 19½" d x 9" h

Item #423123*

Mfg. #SG-31
Cs Pk 1 x 1 ea
Cs Wt 6.00 lb

* Special Order



APW
wyott



#HRS-31
with SG-31



EQUIPMENT

POPCORN POPPER

- Stainless steel construction with tempered glass panels
- 6-8 oz popper capacity
- 19" w x 15½" d x 25½" h
- 120V, 1125 watts

Item #423130

Mfg. #MPC-1A
Cs Pk 1 x 1 ea
Cs Wt 68.00 lb



APW
wyott



APW
wyott

HEATED WARMER

- Stainless steel exterior
- 4 quart capacity
- Pump dispenser
- 120V

Item #423127

Mfg. #CCW
Cs Pk 1 x 1 ea
Cs Wt 11.00 lb



HEATED SNACK MERCHANDISER

- Ideal for sandwiches, donuts, baked goods and concession type snack items
- Stainless steel frame with tempered glass
- Impact resistant polycarbonate door
- Heating elements are made of Incoloy® nickel-based metal for high temperature corrosion resistance
- Two movable shelves 13" x 10½"
- 14" w x 14" d x 22" h
- 120V, 390 watts

Item #476268*

Mfg. #6457
Cs Pk 1 x 1 ea
Cs Wt 33.00 lb

* Special Order



NEMCO
FOOD EQUIPMENT

"Exceeding your expectations"



SOUP MERCHANDISER

- 7 qt twin well – perfect for all soups
- Stainless steel construction ensures durability
- Heating element maintains even holding temperature and prevents hot spots
- Single thermostat and adaptor plate
- Comes with interchangeable tab cards bearing names of the 100 most popular soups
- 25½" w x 16" d x 20¼" h
- 120V, 1200 watts

Item #476271*

Mfg. #6510-D7
Cs Pk 1 x 1 ea
Cs Wt 36.00 lb

* Special Order



NEMCO
FOOD EQUIPMENT

"Exceeding your expectations"





#6480-365



HEATED SHELF MERCHANDISERS

- Aluminum dissipater plate for even heat distribution
- Stainless steel exterior
- Tempered glass sides
- Independent heat and light controls for each shelf
- Adjustable thermostat
- Adjustable divider rods for easy organization of food product
- 2½" adjustable feet • 120V
- Cs Pk 1 x 1 ea



Item #	Mfg. #	Description	Cs Wt
531733	6480-305	30" Slanted, 2 Shelves, 1460W	110.00 lb
529094	6480-365	36" Slanted, 2 Shelves, 1800W	120.00 lb
531734	6480-301	30" Horizontal, 1 Shelf, 730W	80.00 lb
531735	6480-361	36" Horizontal, 1 Shelf, 900W	90.00 lb

EUROPEAN COUNTERTOP HEATED DISPLAY CASES

- Curved glass case enhances presentation of food
- Brushed stainless steel and tempered glass construction
- French curved glass that tilts forward for ease of cleaning
- Extra-large water reservoir controls humidity, while thermostatic controls hold a temperature range of 100° to 220°F
- 4½" adjustable legs • 120V
- Cs Pk 1 x 1 ea



#6431



Item #	Mfg. #	Description	Cs Wt
488912	6430	Holds (2) 12" x 20" x 2½" Pans, 1775W	120.00 lb
531736	6431	Holds (3) 12" x 20" x 2½" Pans, 2275W	130.00 lb

CAYENNE® HOT FOOD MERCHANDISERS

- Illuminated display with 3 adjustable shelves
- Convenient accessible front & rear sliding doors
- Humidified • Excellent point-of-sale
- Thermostatically controlled with 85° to 175°F temp range
- 1500 watt, 120V
- Cs Pk 1 x 1 ea



Setting the Standard™



#40733

Item #	Mfg. #	Description	Cs Wt
530824	40733	26"	85.00 lb
530825	40734	36"	108.00 lb
530826	40735	47"	156.00 lb

SERVEWELL® SL HOT FOOD TABLES

- Heavy-gauge stainless steel body, legs, and base for strength and durability
- Thermoset wells with dome heating elements use up to 25% less energy
- No spillage pans needed, highly efficient
- Integrated front plate rest - durable and easy to clean
- Thermostat controls automatically adjust water temperature and food volume changes
- Low water indicator light
- Mechanical guards on all controls and power switch for safety and reliability
- 10' power cord is bottom-mounted to stay out of the way
- Ships knocked down
- 29½"d x 34"h
- 700W per well, 120V
- Cs Pk 1 x 1 ea



Setting the Standard™



#38213

Item #	Mfg. #	Description	Cs Wt
530840	38213	3 Well, 46" wide	128.00 lb
530841	38214	4 Well, 61¼" wide	200.00 lb

Items noted with an FOB truck are FOB Factory. Freight charges will be added to all orders placed. Non-returnable items.





VOLLRATH
Setting the Standard

CAYENNE® SANDWICH PRESSES

- Durable cast aluminum plates
- Drip cup to catch excess grease
- Heat resistant handle
- Thermostat heat control to 570°F
- 120V, 1800 watt
- Cs Pk 1 x 1 ea



Item #	Mfg. #	Description	Cook Area	Cs Wt
Panini - Ribbed Plates				
530814*	40790	Non-Stick	12 ³ / ₁₆ " x 13 ³ / ₁₆ "	30.00 lb
Flat Plates				
530816*	40791	Natural	12 ³ / ₁₆ " x 13 ³ / ₁₆ "	28.40 lb
530818*	40793	Natural	15 ⁵ / ₈ " x 17 ¹ / ₈ "	51.94 lb

* Special Order

VOLLRATH
Setting the Standard



CAYENNE® PANINI SANDWICH PRESS

- Heavy duty cast iron plates for durability and superior heat retention
- Pivot-action top plate to suit any food thickness
- Ribbed top and bottom plates for grilled food presentation
- Thermostatically controlled up to 570°F
- Satin-finish stainless steel body construction
- 9⁵/₈" x 16¹/₈" cooking area
- 120V, 1800 watt

Item #530821*

Mfg. #40794
Cs Pk 1 x 1 ea
Cs Wt 46.00 lb

*Special Order



VOLLRATH
Setting the Standard

CAYENNE® ELECTRIC GRIDDLES

- High output for busy kitchens
- Heavy duty cooking surface for high heat retention
- Fast start-up and recovery times
- Maintenance is easier with internally mounted grease collection pan
- 2¹/₂" back and sloped side splashes
- Griddle plate is fully welded to base
- Cs Pk 1 x 1 ea



Item #	Mfg. #	Description	Cs Wt
530809	40715	14", 110V	49.00 lb
524700	40716†	24", 220V	78.00 lb
530810	40717†	36", 220V	110.00 lb

†Single Phase



VOLLRATH
Setting the Standard



CAYENNE® GAS GRIDDLES

- Polished surface 3/4" thick top plate
- Welded seams eliminate grease and dirt traps
- Cooking surface depth: 19", 2³/₄" backsplash, 2¹/₄" side splashes
- Heavy-duty legs with 4" to 5¹/₂" adjustment range
- Shipped set up for natural gas, includes kit for conversion to propane
- Includes regulator and gas valve
- Cs Pk 1 x 1 ea



Item #	Mfg. #	Description	Cs Wt
530812	40720	24", 56,000 BTU	174.00 lb
530815	40721	36", 84,000 BTU	244.00 lb
530817	40839	48", 112,000 BTU	412.00 lb



PANINI GRILL

- Brushed stainless steel body
- Ribbed cast iron plates
- Adjustable thermostat to 570°F
- Removable drip tray
- Heat-resistant handles
- 120V

Item #459659
Mfg. # WPG250
Cs Pk 1 x 1 ea
Cs Wt 64.00 lb

WARING
COMMERCIAL



Items noted with an FOB truck are FOB Factory. Freight charges will be added to all orders placed. Non-returnable items.



CAYENNE® CHAR-BROILERS

- Stainless and aluminized steel with a fully welded construction
- Reversible grates for narrow or wide grilling surface
- Kits for both radiant and lava rock setup included
- Cs Pk 1 x 1 ea



#40730

Item #	Mfg. #	Description	Cs Wt
530819	40730	24", 56,000 BTU	160.00 lb
530820	40731	36", 84,000 BTU	226.00 lb
530823	40837	48", 112,000 BTU	392.00 lb



CAYENNE® GAS HOT PLATES

- Stainless and aluminized steel with fully welded construction for durability and long life
- Shipped natural gas – includes kit regulator for field conversion to propane
- Front access openings for lighting of pilot lights
- Heavy-duty legs with 4" to 5½" adjustment range
- Heavy-duty cast iron grates with "center slope" holes
- Full-width stainless steel drip pan
- Bull-nose design to protect from burns
- Cs Pk 1 x 1 ea



#40736

Item #	Mfg. #	Description	Cs Wt
530835	40736	12"w, 2 burners, 52,000 BTU	96.00 lb
531319	40737	24"w, 4 burners, 104,000 BTU	169.00 lb
525549	40738	36"w, 6 burners, 156,000 BTU	228.00 lb



APW Wyott GAS GRIDDLES

- ¾" thick flat polished griddle plate
- Stainless steel and aluminized steel construction
- 4" adjustable legs
- Field convertible gas regulator for natural or LP
- 3-year limited warranty and a 1-year on-site labor warranty
- Cs Pk 1 x 1 ea

#GGM-24H



Item #	Mfg. #	Description	Cs Wt
Thermostatic			
531729	GGT-24H	24"w, 2 burners, 50,000 BTU	223.00 lb
438808	GGT-36H	36"w, 3 burners, 75,000 BTU	306.00 lb
Manual			
509889	GGM-24H	24"w, 2 burners, 50,000 BTU	214.00 lb
531730	GGM-36H	36"w, 3 burners, 75,000 BTU	306.00 lb



#GCB-24H

GAS CHAR-BROILERS

- Stainless steel and aluminized steel construction
- Field convertible gas regulator for Natural or LP gas
- Bottom mounted grease collection pan
- Removable cast iron top grates for easy cleaning
- Cs Pk 1 x 1 ea



Item #	Mfg. #	Description	Cs Wt
Radiant			
526659	GCB-24H	24"w, 2 burners, 80,000 BTU	122.00 lb
526656	GCB-36H	36"w, 3 burners, 120,000 BTU	174.00 lb
CharRock			
428872	GCRB-24H	24"w, 2 burners, 80,000 BTU	148.00 lb
531728	GCRB-36H	36"w, 3 burners, 120,000 BTU	203.00 lb

GAS HOT PLATES

- Heavy duty stainless steel construction
- Cast iron grates and burners
- Stainless steel drip pan
- Field convertible gas regulator for natural or LP
- 3 year limited warranty, and a 1 year on-site labor warranty
- Cs Pk 1 x 1 ea



#GHP-4H



Item #	Mfg. #	Description	Cs Wt
523636	GHP-2H	12"w, 2 burners, 60,000 BTU	63.00 lb
531732	GHP-4H	24"w, 4 burners, 120,000 BTU	129.00 lb



NATURAL LAVA ROCK

- Replacement volcanic rock for gas grills
- 7 lb bag (covers approximately 300 sq inches)

Item #479534
Mfg. #5002
Cs Pk 1 x 1 ea
Cs Wt 7.00 lb



GAS CONNECTOR KITS

- Quick-disconnect one end, FreeSpin rotating gas fitting other end
- Welded fitting connections • Safe stainless braid
- Extruded coating • ½ PSI max. gas pressure
- Kit includes one 90° street elbow, one CSA-certified foodservice gas ball valve, one SureLink restraining cable, adjustable from 3' to 5' lengths and all necessary hardware
- Male to quick-disconnect hose
- 48" long
- Cs Pk 1 x 1 ea



Item #	Mfg. #	Description	Cs Wt
487149	HG-4C-48SK	½" NPT	7.00 lb
487148	HG-4D-48SK	¾" NPT	8.00 lb

Items noted with an FOB truck are FOB Factory. Freight charges will be added to all orders placed. Non-returnable items.



EQUIPMENT



#40707

CAYENNE® COUNTERTOP ELECTRIC FRYERS

- Hinged element box and removable stainless steel tank for easy cleaning
- Compact design
- Automatic cut-out at 390°F prevents fire
- 120V
- Cs Pk 1 x 1 ea



Item #	Mfg. #	Description	Cs Wt
530805*	40705	10 lb Oil, 17 lb of Fries/Hr	15.00 lb
530806*	40707	2 x 10 lb Oil, 34 lb of Fries/Hr	30.98 lb

* Special Order



COUNTERTOP DEEP FRYER

- Twin steel wire baskets – 3 lb food capacity
- Hinged heating element and removable stainless steel tank (8 lb fat cap.)
- 30 minute timer
- 120V, 1800 watts
- Limited 1 year warranty

Item #459658

Mfg. #WDF75RC

Cs Pk 1 x 1 ea

Cs Wt 25.60 lb

Sold in case pack only.



EQUIPMENT

CARE OF FRYER OIL

Keep your oil at the proper temperature – around 340°F Oil will break down at double the rate for every 10 degrees over 350°F

Keep your oil free of any contaminants such as:

Water – never load frozen foods over the frypot.

Soap – clean, rinse and dry the pot extremely well.

Salt – never salt your food over the oil.

Food Particles – filter in a consistent manner.

Air & Light – keep frypots covered when not in use.

IN-CHAMBER VACUUM PACK MACHINE

- Suitable with wet or dry products
- Extends the shelf life of foods and cuts down on waste due to spoilage
- Vacuum packing opens the pores in foods, creating an excellent way to quickly marinate meats
- 10 $\frac{1}{2}$ " x 15 $\frac{3}{4}$ " x 6 $\frac{5}{16}$ " chamber
- 120V

Item #530842

Mfg. #40850

Cs Pk 1 x 1 ea

Cs Wt 99.00 lb



VACUUM PACK BAGS

In Chamber – Regular

- Total thickness: 3.5mm
- Maximum cooking temperature: 158°F (70°C)
- Cs Pk 1 x 100

Item #	Mfg. #	Description	Cs Wt
534899	40815	8" x 12"	2.30 lb

Sold in case pack only.

In Chamber – Boil-In

- Total thickness: 4.0mm
- Maximum cooking temperature: 212°F (100°C)
- Cs Pk 1 x 100

Item #	Mfg. #	Description	Cs Wt
534794	23850	6" x 8"	5.50 lb
534796	23854	12" x 16"	6.70 lb

Sold in case pack only.

Out-of-Chamber

- Not suited for use with liquids
- Cs Pk 1 x 100

Item #	Mfg. #	Description	Cs Wt
534897	40813	8" x 12"	2.45 lb

Sold in case pack only.

OUT-OF-CHAMBER VACUUM PACK MACHINE

- Out-of-chamber vacuum packing – requires specific bag type
- Not suited for use with liquids
- 12 $\frac{3}{16}$ " long sealing bar
- 120V

Item #534895

Mfg. #40858

Cs Pk 1 x 1 ea

Cs Wt 16.40 lb



Items noted with an FOB truck are FOB Factory. Freight charges will be added to all orders placed. Non-returnable items.





HEAVY DUTY SLICERS

- Direct drive gear transmission for powerful cutting applications such as cheese
- Intuitive setup includes simple main switch and variable speed control
- 12" (30.5 cm) slicer with non-stick finish
- 27"d x 18"h
- ½ hp, 110V
- Cs Pk 1 x 1 ea

Item #	Mfg. #	Description	Cs Wt
530834*	40849	Belt-Driven, 20"w	78.00 lb
530822*	40799	Gear-Driven, 21"w	85.20 lb

* Special Order

DELUXE SLICER

- Automatic carriage slices approximately 40 slices per minute for maximum operational efficiency
- Intuitive setup includes simple main switch and variable speed control
- Can also be used manually
- Includes easy kickstand to prop up slicer for cleaning
- 12" (30.5 cm) deluxe slicer with non-stick finish
- 21"w x 27"d x 23"h
- ¾ hp, belt-driven, 110V
- Cs Pk 1 x 1 ea

Item #530828
Mfg. #40800
Cs Pk 1 x 1 ea
Cs Wt 130.00 lb



LIGHT & MEDIUM DUTY SLICERS

- Space-saver design with smaller footprint for tight areas
- Ideal for casual slicing needs such as coffee shops, small restaurants, bus shops, and delis
- Non-stick finish • ½ hp, belt driven, 110V • Cs Pk 1 x 1 ea

Item #	Mfg. #	Description	Cs Wt
525104	40803	10" Light Duty, 17"w x 21"d x 15"h	43.12 lb
530831	40804	12" Medium Duty, 18"w x 22"d x 16"h	48.72 lb

MEAT GRINDERS

- Complete stainless steel body, head and tray
- Strict compliance with hygiene and safety standards
- Reliable under the most demanding conditions
- Energy efficient motor and precision gear drive
- No sharp corners or seams
- Forward and reverse switch
- Supplied with ½" and ¾" grinder plates
- 110V • Cs Pk 1 x 1 ea

Grinds 264 lb/hour, 1 hp

Item #530827*
Mfg. #40743
Cs Wt 57.74 lb

* Special Order

Grinds 528 lb/hour, 1½ hp

Item #530829
Mfg. #40744
Cs Wt 106.00 lb



VOLLRATH®
Setting the Standard™



VOLLRATH®
Setting the Standard™



Not Available via FedEx®.

EQUIPMENT STANDS

- Stainless steel top for long working life
- 1" adjustable feet for optimizing height and stability
- Back and side splashes contain spills and keep equipment securely on the table
- Height adjustable galvanized bottom shelf for convenient working storage
- Cs Pk 1 x 1 ea

Item #	Mfg. #	Description	Cs Wt
530837*	40740	24" wide	35.72 lb
530838*	40741	36" wide	45.92 lb
531044*	40742	48" wide	56.00 lb

* Special Order

Items noted with an FOB truck are FOB Factory. Freight charges will be added to all orders placed. Non-returnable items.



EQUIPMENT

COUNTERTOP WARMING & BAKING OVEN



"Exceeding your expectations"

- Perfect for heating pizza, cookies, pastries, rolls, fresh breads, pies, toasted sandwiches and other pre-cooked items
- Stainless steel unit
- No ventilation required
- Thermostat control to 700°F
- Independent on/off switches for upper and lower heating elements
- Sixty-minute timer
- Comes with two 15½" x 14¼" shelves but can hold up to four shelves
- 19½" w x 22" d x 23¼" h
- 120V, 1500 watts

Item #476270

Mfg. #6200
Cs Pk 1 x 1 ea
Cs Wt 80.00 lb



COUNTERTOP CONVECTION OVEN

- Convection bake, roast, bake, rotisserie and broil functions
- Heavy-duty brushed stainless steel finish
- 1.5 cubic feet – fits 4 half size sheet pans
- Includes stainless steel baking sheet/drip pan and 3 nickel-plated baking racks
- Clear-view tempered glass window
- 120V, 1700 watts

Item #483645

Mfg. #WCO500
Cs Pk 1 x 1 ea
Cs Wt 50.00 lb



#40703



Setting the Standard™



CAYENNE® CONVECTION OVENS

- Stainless steel exterior and interior
- Interior light
- Custom baffle fan and diffuser plate for reliable baking
- Accommodates half-size pans
- Cs Pk 1 x 1 ea
- Non-tip chrome plated steel shelves
- Bake timer automatically switches off after a preset period



Item #	Mfg. #	Description	Cs Wt
531043	40703	3 Shelves, 23⅞" w x 24½" d x 18⅞" h	70.00 lb
530799	40701	4 Shelves, 23⅞" w x 24½" d x 23¼" h	86.00 lb
530804†	40702	4 Shelves, 32⅞" w x 29¾" d x 26⅞" h	166.00 lb

†Also holds full-size pans

COUNTER DECK OVEN

- All sides insulated with stainless steel top, sides and door liner
- 15 minute timer
- Oven compartment has two ceramic phosphate decks removable for easy cleaning
- 22¼" w x 24¼" d x 17⅞" h
- 120V
- Thermostat range 300° to 550°F

Item #423099

Mfg. # CDO-17
Cs Pk 1 x 1 ea
Cs Wt 104.00 lb



MICROWAVE OVEN

- Manual control
- Digital power level, time and program display
- 6 power levels
- 60 minute timer
- Stainless steel exterior and interior
- 0.9 cu ft cooking chamber
- 20½" w x 18⅞" d x 12¼" h
- 120V, 1450 watts

Item #537552

Mfg. #40830
Cs Pk 1 x 1 ea
Cs Wt 46.10 lb



Setting the Standard™





SUPER SHOT STEAMER

- Reheats and restores flavors in seconds
- Cast aluminum and stainless steel construction with powder coated top
- Self-contained water reservoir
- Simple push-button operation
- Illuminated on/off rocker switch
- Holds half-size 2½" deep pan
- 16½"w x 17¼"d x 8¼"h

Item #523553
Mfg. #6600
Cs Pk 1 x 1 ea
Cs Wt 40.00 lb



FRESH-O-MATIC® FOOD STEAMER

- Heats or reheats fresh, precooked or frozen food entrées in a matter of a few seconds to a few minutes it can taste like it's freshly cooked once again

- 16½"w x 12"d x 11¾"h
- 1500 watts, 120V

Item #538598*
Mfg. #6625
Cs Pk 1 x 1 ea
Cs Wt 38.80 lb
*** Special Order**



ABBREVIATIONS COMMON TO THE FOODSERVICE INDUSTRY

CSA	CSA International
BTU	British Thermal Unit
NSF	National Sanitation Foundation
UL	Underwriters Laboratory
AC/DC	Alternate Current/Direct Current
ETL	Edison Testing Laboratory
NAFEM	National Association of Foodservice Equipment Mfg.
NEMA	National Electrical Manufacturers Association
ASM	American Society of Mechanical Engineers
HACCP	Hazardous Analysis Critical Control Points
KW	Kilowatt
KWH	Kilowatts Per Hour
S/S	Stainless Steel
HP	Horsepower
AMP	Ampere
Hz	Hertz



#RC-S300



#RC-P300

ELECTRIC RICE COOKERS

- Keeps rice warm and fresh
- Non-stick inner pot seals in moisture
- New technology, new design, no hassle
- Conforms to UL-197 & NSF-4
- 30 cups (60 cups cooked)
- 120V, 1550 watts
- One year warranty
- Cs Pk 1 x 1 ea



RC-S300

- Keeps warm up to 6 hours
- Fingerprint-proof satin finish on heavy-duty stainless steel body
- Energy efficient heat absorbing system

RC-P300

- One hour warming function

Item #	Mfg. #	Description	Cs	Wt
538168	RC-S300	Advanced Cooker/Warmer w/Hinged Cover	23.06	lb
538169	RC-P300	Cooker	17.64	lb

LUGS

- Ideal for transporting and storing all types of products – warm or cold food processing, preparation, etc
- High density, polyethylene
- Built-in handles
- Gray
- 16"w x 25"l x 8"h



Item #502495

Mfg. #WHPL-8GY
Cs Pk 1 x 6 ea
Cs Wt 6.00 lb
Sold in case pack only.

BUN PAN RACK

- Proof, store, and transport 18" x 26" bun pans
- End-load – holds 20 pans on 3" spacing
- Heavy duty aluminum with welded angle slides
- Four 5" polyurethane swivel stem casters
- 21"w x 26"l x 69¾"h

Item #501132

Mfg. #AL-1820B
Cs Pk 1 x 1 ea
Cs Wt 30.00 lb



Items noted with an FOB truck are FOB Factory. Freight charges will be added to all orders placed. Non-returnable items.



EQUIPMENT

KNOCK-DOWN PAN RACK

- Constructed of all welded 1" aluminum tubing with heavy duty, all welded angle pan supports
- Holds up to (20) 18" x 26" bun pans
- End load with 3" spacing
- Four 5" swivel stem casters
- Shipped knock-down
- 21"w x 26"l x 69"h

Item #483101

Mfg. #ADE1820B/KDA
Cs Pk 1 x 1 ea
Cs Wt 35.00 lb



Not Available via FedEx®.



BAKERY RACK COVER

- Heavy duty clear plastic with 3 reinforced zippers
- Clear plastic
- Retards dehydration and enhances proofing
- 23"w x 28"l x 61"h

Item #483102

Mfg. #SRC-58/3Z
Cs Pk 1 x 1 ea
Cs Wt 3.00 lb



NON-INSULATED ECONOMY HEATER PROOFER

- Heavy duty, channel construction designed for durability
- Air baffle and circulating air blower provide even heat distribution
- 5" polyurethane plate casters (2 locking)

- Dual proof/heat control: "Proof" mode: Humidity from 30% to 95%, temps up to 115°F "Heat" mode: Nominal temps up to 180°F
- Clear door w/extruded anodized aluminum frame that will not dull
- All controls are accessible without opening cabinet door
- Easy to read LED thermometer
- Pan capacity: (35) 18" x 36" pans
- 21"w x 30¾"l x 68"h
- 120V

Item #493204

Mfg. #NHPL-1836-ECO
Cs Pk 1 x 1 ea
Cs Wt 235.00 lb



#CR-162

CAN RACKS

- Self feeding – keeps stock rotated
- Holds 162 - #10 cans or 216 - #5 cans
- Vertical uprights and cross braces constructed of 1½" aluminum tubing
- Cs Pk 1 x 1 ea



5" mobile polyurethane casters, (2) swivel w/brakes
27½"w x 35"l x 76"h

Item #486002

Mfg. #CR-162M
Cs Wt 66.00 lb



Stationary
25¼"w x 35"l x 71"h

Item #510096

Mfg. #CR-162
Cs Wt 60.00 lb



ALUMINUM SHEET PAN RACK

- Heavy duty
- 20 tier
- Assembly required
- 26"l x 20¼"w x 69"h

Item #505001

Mfg. #ALRK-20
Cs Pk 1 x 1 ea
Cs Wt 20.94 lb



Not Available via FedEx®.



Items noted with an FOB truck are FOB Factory. Freight charges will be added to all orders placed. Non-returnable items.





STOP Not Available via FedEx®.

SHELVING KITS

- Provides a complete shelving unit in a single box
- Each kit contains four shelves with split sleeves and four – 74" stationary split posts
- Shipped knocked down
- Cs Pk 1 x 1 set

Item #	Mfg. #	Description	Cs Wt
Green Epoxy Coated			
531746	FK183674GN	36" wide	51.70 lb
531745	FK184874GN	48" wide	61.10 lb
Chromate Finish			
531744	FK183674CH	36" wide	51.70 lb
531743	FK184874CH	48" wide	61.10 lb

Sold in case pack only.



#FK183674CH



#FK184874GN
Shown w/optional casters



STOP Not Available via FedEx®.



Components

CAMSHELVING® ELEMENTS 4-SHELF STARTER UNITS

- Composite material is as strong as steel
- Flexible design fits any space
- Non-corrosive construction allows usage in wet or dry environments and in temps from -36° to 190°F
- Shelf plates protected with Camguard® antimicrobial
- Includes vented shelf plates for 4 shelves, 4 posts, 8 stationary traverses, dovetails and instructions
- Lifetime warranty against rust and corrosion
- Brushed graphite
- Cs Pk 1 x 1 ea

Item #	Mfg. #	Description	Cs Wt
531449	ESU244872580	48"l x 72"h, 800 lb cap.*	73.00 lb
531450	ESU246072580	60"l x 72"h, 600 lb cap.*	84.87 lb

*Capacity per shelf



Components

STOP Not Available via FedEx®.



CAMSHELVING® 4 SHELF STARTER UNITS

- Smooth polypropylene surface is easy to wipe clean
- Can be used in any environment – withstands temperatures as cold as -36°F – weldless and rustproof so it can be used in wet areas – sleek appearance even provides a new way to merchandise products!
- Shelf plates and traverses can be easily removed and washed in a commercial dishwasher
- Posts and traverses are made with a steel core for strength and durability to last
- Starter unit includes four posts, two sets of 24" wide post connectors, traverses and vented shelf plates for 4 shelves
- Limited lifetime warranty against rust and corrosion
- Color: Speckled Gray
- Cs Pk 1 x 1 ea

Item #	Mfg. #	Description	Cs Wt
380053	CSU44487-480	48"l x 72"h, 800 lb cap.*	109.00 lb
380054	CSU44607-480	60"l x 72"h, 600 lb cap.*	118.64 lb

*Capacity per shelf

STOP Not Available via FedEx®.



NSF

Components

CAMSHELVING® WALL SHELF KITS

- Smooth polypropylene construction
- Includes one solid shelf, two heavy duty supports and mounting hardware
- 150 lb load capacity
- Shelves snap on and off for easy cleaning
- Speckled Gray
- 18"w x 48"l x 13½"h

Item #458976
Mfg. #CSWS1848SK480
Cs Pk 1 x 1 ea
Cs Wt 14.74 lb

CAMBRO
TRUSTED FOR GENERATIONS™

STOP Not Available via FedEx®.

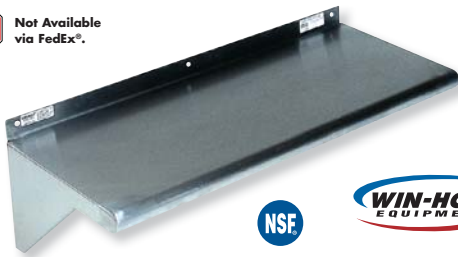

NSF

WIN-HOLT
EQUIPMENT

WALL MOUNTED SHELVES

- 18 gauge stainless steel
- 12" wide
- Cs Pk 1 x 1 ea

Item #	Mfg. #	Description	Cs Wt
483095	SSWMS124/KD	48" long	8.16 lb
483107	SSWMS125/KD	60" long	11.16 lb

STOP Not Available via FedEx®.

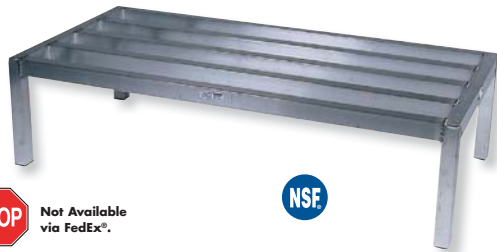

NSF

DUNNAGE RACKS

- All welded 1½" x 1½" heavy duty, rustproof aluminum tube construction
- 20"w x 12"h
- Cs Pk 1 x 1 ea

Item #	Mfg. #	Description	Cs Wt
483241	DASQ-3-1220	36" long, 2100 lb cap.	9.00 lb
483242	DASQ-4-1220	48" long, 1800 lb cap.	10.00 lb

WIN-HOLT
EQUIPMENT



NSF



Camlink



STOP Not Available via FedEx®.

SLOTTED TOP DUNNAGE RACKS

CAMBRO
TRUSTED FOR GENERATIONS™

- Made of heavy-duty polyethylene that won't rust or corrode
- 4" square legs provide exceptional strength
- Cloverleaf shaped Camlink locks two or more racks together (1 included)
- 21"w x 12"h
- Cs Pk 1 x 1 ea

Item #	Mfg. #	Description	Cs Wt
Dark Brown			
439144	DRS300-131	30" long, 1500 lb cap.	21.70 lb
399068	DRS360-131	36" long, 1500 lb cap.	25.77 lb
399069	DRS480-131	48" long, 3000 lb cap.	34.07 lb
Speckled Gray			
389261	DRS360-480	36" long, 1500 lb cap.	25.77 lb
389262	DRS480-480	48" long, 3000 lb cap.	34.07 lb
401469	DRS600-480	60" long, 3000 lb cap.	42.37 lb

BUYING SHELVING

When buying shelving, consider what you will be storing on the shelves. Shelving intended for refrigerated storage should meet different requirements than shelving for dry storage. Carefully consider the weight of the items you intend to place on shelving. Are you storing items that would be easier and safer to store on dunnage racks?

HACCP (HAZARD ANALYSIS OF CRITICAL CONTROL POINTS)

HACCP is a systematic approach to controlling foodborne illness. A HACCP plan is created when you have put in place a plan that documents proper procedures, using forms to track performance and compliance of such procedures. In addition the process includes specific information about who is responsible for carrying out the plan. Managers and employees then have an up-to-date document that describes procedures to be followed to ensure safe food. Managers must use the document to record all safe measures in use, as well as to describe any changes they may have made. Any corrective actions taken must also be on file and in the plan as well. By following the seven basic principles of HACCP you are on your way to serving safer food.

SEVEN PRINCIPLES BEHIND HACCP

1. Hazard Analysis: Your first step is to determine the menu items most likely to cause illness and what could go wrong with them.

2. Determine Critical Control Points: Focus on how and where to make the food safe. Cooking, cooling, reheating and storing may be critical control points.

3. Set Critical Limits: Standardize your cooking temperatures, cooling times, reheating temperatures and times, storage practices, and any other safety concerns.

4. Develop Monitoring Procedures: Determine how often you

should take temperature readings, test sanitizer strength and set up forms or charts to record the data collected.

5. Take Corrective Action: Describe what to do if cooking, cooling, reheating, sanitizing or storing is out of set safe limits.

6. Set Up Record Keeping System: Determine what needs to be recorded, where records are to be kept, who has access to the records and how long you will keep records on file.

7. Verify The System is Working: Set a specific day of the week, bi-weekly or monthly to review the record keeping to ensure the system is operating effectively.



RECEIVING:

Before accepting deliveries, make sure the temperature is within prescribed limits. Check both surface and interior temperatures: use an Instant Read or a Pocket Digital Thermometer for a quick interior check and an Infrared Thermometer for surface temperatures.

- Refrigerated foods – no higher than 41°F (5°C).
- Frozen foods – no higher than 0°F (-17.8°C) – use a Hand-held Thermocouple Thermometer with a Frozen Food Probe for quick, easy inspection of frozen food deliveries.
- Discard dry goods if there is any dampness, discoloration or if packaging is damaged.

Remember: Always refuse foods that show any signs of spoilage!

STORING:

All foods must be properly stored to minimize the risk of bacterial growth or contamination.

- Refrigerated foods must be stored at 41°F (5°C) or lower – use separate Refrigerator Thermometers for different food storage temperatures.
- Frozen foods need an air temperature below 0°F (-17.8°C) – use two Freezer Thermometers – one at the warmest point, the other at the coldest – to monitor air temperature.
- Dry stored food should be kept at 50°F (10°C) in a well-lit, ventilated room with a maximum of 60% relative humidity. Use a Temperature and Humidity Guide Wall Thermometer or Remote Sensor Thermometer to monitor storage room temperatures and humidity levels.

Remember: Check storage temperature at least twice each day!

PREPARING/COOKING:

Foodborne pathogens are killed by safe cooking temperatures. Use a Deep Fry Dial Thermometer to check deep frying oil temperatures to prevent cooking surface of foods too quickly. Use an Infrared Thermometer to ensure grills, fryers, and ovens maintain the right temperature for uniform cooking. Use Pocket Digitals, Thermocouple or Disposable Thermometers to ensure that 2011 FDA Guidelines for safe internal temperatures are consistently met.

- Poultry, stuffed meats and fish, wild game: 165°F (74°C) for at least 15 seconds.
- Pork, ground meat and inspected game meats,

veal, lamb, mutton, eggs for immediate use: 155°F (68°C) for at least 15 seconds.

- Whole beef and pork roast: 145°F (63°C) for at least 3 minutes.

SERVING/HOLDING:

Hold foods out of the Danger Zone – hot foods above 140°F (60°C) and cold foods below 41°F (5°C) – to inhibit bacteria. Always use thermometers – a Hot/Cold Holding Cabinet Thermometer or Hand-Held Thermocouple Thermometer with an Air Probe – to check air temperatures in holding cabinets and under heat lamp warmers.

Remember: Built-in Thermostats may be misleading because they only measure air temperature immediately adjacent to sensors which may not be uniform throughout the holding area

COOLING:

After cooking, chill foods – especially meats – as rapidly as possible to minimize their time in the Danger Zone and limit bacterial growth. Chill from 140°F (60°C) to 70°F (21°C) within 2 hours, then from 70°F (21°C) to 41°F (5°C) within 4 hours. Use a Pocket Digital Thermometer, or a Hand-Held Thermocouple Thermometer with Interchangeable Probes.

Remember: The larger the surface area, the faster the food will cool – cut roasts into smaller portions and distribute liquids among several smaller pans to speed chill-time.

REHEATING:

Some bacteria survive cooking and multiply to dangerous levels during chill-down. Food must be reheated to an internal temperature of 165°F (74°C) to eliminate new pathogens. Use a Bi-Therm, Pocket Digital or Hand-Held Thermocouple Thermometer to ensure all foods are reheated adequately. Reheating kills pathogens, it won't eliminate toxins, such as *Staphylococcus aureus*, so remember these important rules:

- Never reheat food more than 2 days old
- Never add old foods to new
- Reheat foods only once – then discard
- Enforce strict personal hygiene standards

Remember: An Infrared Thermometer is ideal for quickly and inconspicuously checking surface temperatures in holding cabinets, on salad bars and steam tables.



Temperature Zones

Fahrenheit

220°

210°

212°F Water boils at sea level.

200°

190°

180° - 195°F Required for non-chemical sanitizing dishwashers.

180°

170°

Cook to safe internal temperatures:

160°

165°F - most bacteria killed
Recommended internal temperature:

Eggs at least **155°F**

Pork at least **160°F**

Poultry **170°F**

Beef:

ground, medium well at least **160°F**

ground, well **170°F**

140°

130°

140°F Minimum hot-holding temperature, including ready-to-eat & buffet style.

120°

110°

120°F Minimum hot water temperature in a food facility.

100°

90°

80°

70°

60°

50°

Danger Zone
40°-140°F

40°

40°F Maximum cold holding temperature.

30°

40°F Thaw frozen foods at this temperature.

20°

35°-40°F Set refrigerator temperature to insure proper food temperature.
32°F Water freezes.

10°

0°

Store frozen foods below 0°F.

-10°

HANDLING GUIDELINES



Maintain cold foods at or below 40°F. Maintain hot foods at or above 140°F.



Potentially hazardous hot food should be cooled rapidly. 140°F cooled to 70°F within 2 hours. 70°F cooled to 40°F within 4 hours. Using shallow pans with a product depth of no greater than 2 inches, the food should be placed in a refrigerator uncovered or loosely covered during the cooling process.



Never defrost food at room temperature. Use a refrigerator, continuously running cold water, a microwave or cook from frozen state. Frozen food that has been thawed should be cooked or otherwise processed before it may be refrozen.



Cook foods to the proper internal temperature. Use a metal probe thermometer to ensure food is cooked properly.



Wash your hands thoroughly with hot soapy water (before and after handling food) for a minimum of 20 seconds.



Avoid handling food when: you are ill, have a skin infection, or have cuts on the hands.



Never cross contaminate from raw to cooked products.



Wash, rinse and sanitize cutting boards and knives between every use.



Reheat leftovers to 165°F internal temperature or higher, stirring constantly to cook evenly or microwave to 195°F. Never reheat leftovers more than once.



Keep kitchens, dining areas and storage rooms free from insects and rodents. Store chemicals away from food.

TAYLOR.



POCKET DIAL THERMOMETERS

- 1" dial, instant read thermometers with 5" stem – high-visibility dial graphics
- Protective case with patented, built-in recalibration wrench

Item #	Mfg. #	Description	Cs Pk	Cs Wt
Standard Grade		- 1-point calibration, $\pm 2^\circ$ at mid-point, $\pm 4^\circ$ at range extreme		
379467	6092N	0° to 220°F, NSF	12 x 1 ea	1.00 lb
379468	5989N	0° to 220°F, Classic Series, NSF	6 x 1 ea	1.00 lb
532167	8018N*	0° to 220°F and -10° to 100°C, 1 3/4" Dial, NSF	6 x 1 ea	1.50 lb
379469	6093N	50° to 550°F, NSF	12 x 1 ea	1.00 lb
398325	6096N	-40° to 160°F	6 x 1 ea	1.00 lb
Superior Grade		- 3-point calibration, $\pm 2^\circ$ accuracy at any point		
379466	6072N	0° to 220°F, NSF	12 x 1 ea	8.00 lb
379472	3621N	0° to 220°F, NSF, Safe-T-Guard™ case*	6 x 1 ea	1.00 lb

* Safe-T-Guard™ case has additive that inhibits growth of bacteria and fungus
Sold in case pack or eaches.

WATERPROOF POCKET DIGITAL THERMOMETERS

- 1.5mm FDA recommended probe diameter
- Waterproof
- -40° to 450°F or -40° to 230°C
- Antimicrobial case & sleeve
- Field recalibratable for use in HACCP program
- Auto-Off feature extends battery life
- Hold feature

Item #405744

Mfg. #9842FDA

Cs Pk 6 x 1 ea

Cs Wt 0.65 lb

Sold in case pack or eaches.

- 1.5mm FDA recommended probe diameter
- Waterproof and dishwasher safe
- Max temperature feature for dishwasher use
- -40° to 450°F or -40° to 230°C
- Field recalibratable for use in HACCP program
- Extra large LCD readout
- Auto-Off feature extends battery life
- Hold feature

Item #444144

Mfg. #9848EFDA

Cs Pk 6 x 1 ea

Cs Wt 1.00 lb

Sold in case pack or eaches.

TAYLOR.

#9842FDA



NSF

#9848EFDA



NSF

TAYLOR.

TAYLOR.

POCKET DIGITAL THERMOMETERS

- On/Off switch
- Pocket case with clip
- Extra battery included
- Cs Pk 6 x 1 ea

Item #	Mfg. #	Description	Cs Wt
379470	9840	-58° to 302°F	0.75 lb
531726	3516	-40° to 302°F, TruTemp®	0.60 lb

Sold in case pack or eaches.



#3516

#9840

NSF

INFRARED THERMOMETER

- Waterproof with recessed optics and HACCP check warning light system
- Includes nylon case and 2 AAA batteries
- -67° to 662°F/-55° to 350°C w/0.5 sec response
- $\pm 1.8^\circ\text{F}$; $\pm 1.0^\circ\text{C}$; D:S 6 to 1; adjustable emissivity
- Min, max, hold, auto off and low battery

Item #469793

Mfg. #9517L

Cs Pk 1 x 1 ea

Cs Wt 0.30 lb

TAYLOR.



KITCHEN



PROBE WIPES

- Individually packaged probe wipes
- Cleans and sanitizes food thermometers and meat probes
- Packet includes: 1 pad saturated with 70% isopropyl alcohol
- 100 packets per box

Item #396857

Mfg. #9999

Cs Pk 10/100 ct

Cs Wt 3.62 lb

Sold in case pack only.

TAYLOR.

T-STICK® DISPOSABLE THERMOMETER

- Shows burger has been cooked to 160°F (71°C) as required by USDA
- Verifies proper temperature in seconds
- Can be saved for HACCP records
- Easy-to-read sensor turns from white to black when food is at or above 160°F ($\pm 1^\circ$)
- Also great for testing dishwasher rinse water!

SAN JAMAR
Smart → Safe → Sanitary

Item #414870

Mfg. #TST9343

Cs Pk 1/250 ct

Cs Wt 0.50 lb

Sold in case pack only.



SAFE-T-GUARD™ SANITIZING SYSTEM

- Includes #3621N antimicrobial thermometer 0° to 220°F and sanitizing tube
- Screw-on top, sealed tube won't leak while sanitizing

Item #446502

Mfg. #9998
Cs Pk 1 x 1 ea
Cs Wt 0.80 lb



TAYLOR.



POCKET THERMOMETER

- Large, easy-to-read display
- Durable, stainless steel stem
- Protective pocket case with clip
- 0° to 220°F
- 1" TruTemp® dial, 4½" stem

Item #531725

Mfg. #3512
Cs Pk 6 x 1 ea
Cs Wt 0.09 oz

TAYLOR.



Sold in case pack or eaches.

MEAT THERMOMETER



- 120° to 212°F
- Classic series, with easy-to-read 2¾" dial and 5½" stem
- Dishwasher safe

Item #379463

Mfg. #5939N
Cs Pk 6 x 1 ea
Cs Wt 1.45 lb

Sold in case pack or eaches.



CANDY & DEEP FRY THERMOMETER

- 100° to 400°F, 50°C to 200°C
- Classic series
- Adjustable pan clip
- Dishwasher safe
- 2¾" dial, 6" stainless steel stem

Item #451171

Mfg. #5911N
Cs Pk 6 x 1 ea
Cs Wt 1.50 lb

Sold in case pack or eaches.



TAYLOR.

MILK/BEVERAGE THERMOMETER

- -40° to 120°F
- -40° to 50°C
- Classic series, 1¾" dial
- Includes adhesive/magnetic backing

Item #379475

Mfg. #5982
Cs Pk 12 x 1 ea
Cs Wt 0.35 lb

Sold in case pack or eaches.

TAYLOR.



KITCHEN

COLD HOLDING THERMOMETER

- -30° to 70°F
- -34° to 20°C
- Professional series
- HACCP guidelines

Item #379474

Mfg. #5981N
Cs Pk 6 x 1 ea
Cs Wt 0.90 lb

Sold in case pack or eaches.



TAYLOR.

HOT HOLDING THERMOMETER

- 100° to 180°F
- 38° to 84°C
- 2½" dial
- Professional series
- HACCP guidelines

Item #379465

Mfg. #5980N
Cs Pk 6 x 1 ea
Cs Wt 1.07 lb

Sold in case pack or eaches.

TAYLOR.



REFRIGERATOR/FREEZER THERMOMETER

- -20° to 80°F, -30°C to 30°C
- Classic series
- Clear plastic lens protects glass tube filled w/non-toxic liquid
- Magnified, easy-to-read face
- Hangs or stands
- 4⅞" x 1¼"

Item #379476

Mfg. #5925N
Cs Pk 6 x 1 ea
Cs Wt 0.75 lb

Sold in case pack or eaches.



TAYLOR.

DIAL OVEN THERMOMETERS

- 100° to 600°F
- 50° to 300°C
- Hangs or stands
- Cs Pk 6 x 1 ea



#5932



#3506

TAYLOR.

Item #	Mfg. #	Description	Cs Wt
467548	5932	3¼" Dial, Classic Series	1.07 lb
531723	3506	2¼" Dial, TruTemp®	1.00 lb

Sold in case pack or eaches.

REFRIGERATION THERMOMETER

- -26° to 86°F, -28° to 30°C
- Two-way hanger or suction cup
- Color zones for food safety
- Red, non-toxic liquid filled tube

Item #398324

Mfg. #5926
Cs Pk 50 x 1 ea
Cs Wt 1.25 lb

Sold in case pack or eaches.



REFRIGERATOR/FREEZER THERMOMETERS

- -20° to 80°F, -30° to 30°C
- 2½" dial
- Hangs or stands

Item #438412

Mfg. #5924

Cs Pk 6 x 1 ea

Cs Wt 1.07 lb

Sold in case pack or eaches.



TAYLOR.

- -20° to 80°F or -30° to 30°C
- 2¼" dial
- Safe temperature zone indicators
- Hangs or stands

Item #532173

Mfg. #3507

Cs Pk 6 x 1 ea

Cs Wt 1.00 lb

Sold in case pack or eaches.



GRILL THERMOMETER

- 100° to 600°F
- 2½" dial – stainless steel construction
- Easy-to-read graphics and red pointer
- Magnetic back holds the thermometer to grill grates
- Cone-shaped wire coil may be attached to the center hex nut for handling with spatula or tongs
- Enclosed design protects coil from dirt and grease

Item #486587

Mfg. #6021

Cs Pk 6 x 1 ea

Cs Wt 1.00 lb

Sold in case pack or eaches.

TAYLOR.



TEMPRITE® DISHWASHER TEST STRIPS

- Offer a precise method for testing final rinse temperatures
- High contrast band verifies proper 180°F (82°C) sanitizing temperature
- Single-use strips may be archived for record keeping

Item #452529

Mfg. #8767

Cs Pk 12/25 ct

Cs Wt 6.00 lb

Sold in case pack only.



TAYLOR.

K-TYPE PROBE

- Step-down penetration probe with 1.575mm tip diameter and 3' lead for Thermocouple Thermometers

Item #532191

Mfg. #9817

Cs Pk 6 x 1 ea

Cs Wt 1.00 lb

Sold in case pack or eaches.

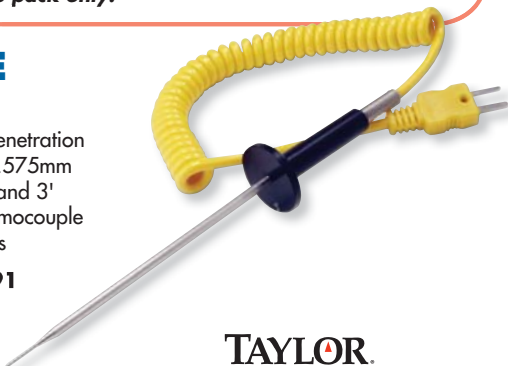

TAYLOR.

ECONOTEMP™ THERMOCOUPLE COMBO PACK WITH PROBE

- -40° to 500°F, -40° to 260°C
- Includes the #32311 Thermocouple with DuraNeedle probe #50336 and lanyard
- Batteries included

Item #437224

Mfg. #93230-K

Cs Pk 1 x 1 ea

Cs Wt 1.00 lb



Cooper
ATKINS®



DIGITAL POCKET TESTS

WATERPROOF PEN STYLE

- Great for testing dishwasher rinse temperature
- -40° to 392°F
- -40° to 200°C
- ±2°F/±1°C
- 2¾" stem length
- Auto shut off
- Accurate for life warranty



Item #437225

Mfg. #DPP400W-0-8

Cs Pk 6 x 1 ea

Cs Wt 1.00 lb

Sold in case pack or eaches.

Cooper
ATKINS®

OVAL STYLE

- -40° to 302°F
- -40° to 150°C
- ±2°F/±1°C
- On-off switch
- 5" stem length

Item #437226

Mfg. #DT300-0-8

Cs Pk 6 x 1 ea

Cs Wt 1.00 lb

Sold in case pack or eaches.



KITCHEN

Cooper
ATKINS®

#1246-01-1



BI-METAL STEM TEST THERMOMETERS

- 1" dial • 5" stem
- Combination pocket sheath and adjustment tool
- Cs Pk 6 x 1 ea



Item #	Mfg. #	Description	Cs Wt
437204	1246-01-1	-40° to 180°F, ±2°	1.00 lb
437208	1246-02-1	0° to 220°F, ±2°	1.00 lb
437209	1246-03-1	50° to 550°F, ±5°	1.00 lb
442979	1246-05-1	0° to 220°F, ±2°	1.20 lb
444704	1236-70-1	0° to 220°F, ±2°	1.00 lb

Sold in case pack or eaches.



DIGITAL POCKET TEST THERMOMETER WITH TEMPERATURE ALARM

- Dishwasher safe
- -40° to 450°F, -40° to 232°C
- ±2°F/±1°C
- 1.5V
- Auto shut off
- Waterproof
- Guaranteed Accurate for Life
- Extra battery included

Item #437289
Mfg. #DFP450W-0-8
Cs Pk 6 x 1 ea
Cs Wt 1.13 lb

Sold in case pack or eaches.



MEAT THERMOMETER

- 130° to 190°F
- 54° to 88°C
- 6" stem, 2½" dial

Item #437213
Mfg. #323-01-1
Cs Pk 6 x 1 ea
Cs Wt 1.45 lb

Sold in case pack or eaches.



CANDY/JELLY/DEEP FRY THERMOMETER

- 200° to 400°F
- 90° to 200°C
- 6" stem, 2½" dial
- Vessel clip included

Item #437214
Mfg. #322-01-1
Cs Pk 6 x 1 ea
Cs Wt 1.50 lb

Sold in case pack or eaches.



DEEP FRY THERMOMETER

- Stainless steel with vessel clip and wooden safety handle
- Perfect for kettle use when deep frying a turkey
- 50° to 550°F
- 10° to 285°C
- 2½" dial, 15" stem

Item #438376
Mfg. #3270-05-5
Cs Pk 1 x 1 ea
Cs Wt 0.46 lb



THERMOMETER PROBE WIPES

- Designed for singular cleaning usage
- Use where sterilization is important
- Each wipe contains 70% isopropyl alcohol
- 200 wipes per pack

Item #438377
Mfg. #9150-0-8
Cs Pk 10/200 ct
Cs Wt 8.00 lb

Sold in case pack only.



HOT HOLDING THERMOMETER

- 100° to 175°F
- 40° to 80°C
- Accuracy: ±3°F
- 2" dial

Item #459686
Mfg. #26HP-01-1
Cs Pk 6 x 1 ea
Cs Wt 1.00 lb

Sold in case pack or eaches.



OVEN THERMOMETER

- 100° to 600°F
- 50° to 300°C
- Accuracy: ±25°F
- 2" dial

Item #437210
Mfg. #24HP-01-1
Cs Pk 6 x 1 ea
Cs Wt 1.10 lb

Sold in case pack or eaches.



GRILL SURFACE THERMOMETER

- Cast aluminum construction
- 100° to 600°F
- 50° to 300°C
- Accuracy: ±25°F
- 2½" reference dial face
- Unique grips for easy removal from hot grill surface

Item #479005
Mfg. #3210-08-1-E
Cs Pk 6 x 1 ea
Cs Wt 1.25 lb

Sold in case pack or eaches.



REFRIGERATOR/FREEZER THERMOMETER

- Stainless steel
- Features a HACCP reference dial
- -20° to 80°F
- -29° to 27°C
- Accuracy: ±2°F/±1°C
- 2" dial

Item #437211
Mfg. #25HP-01-1
Cs Pk 6 x 1 ea
Cs Wt 1.10 lb

Sold in case pack or eaches.



COOLER THERMOMETER

- Magnetic back or self adhesive tabs are provided for mounting to inside of refrigerated glass cases to view through the glass front from the outside
- -20° to 120°F
- -30° to 50°C
- 2" diameter

Item #494506
Mfg. #535-0-8
Cs Pk 12 x 1 ea
Ea Wt 1.00 lb

Sold in case pack or eaches.



HORIZONTAL REFRIGERATOR/FREEZER THERMOMETER

- -40° to 80°F
- -40° to 25°C
- ±2°F/±1°C
- 5" non-toxic spirit filled glass tube
- Stainless steel casing



Item #437212

Mfg. #335-01-1
Cs Pk 6 x 1 ea
Cs Wt 1.00 lb

Sold in case pack or eaches.



REFRIGERATOR/FREEZER THERMOMETER

- -40° to 120°F
- -40° to 50°C
- ±2°F/±1°C
- 3" non-toxic spirit filled glass tube
- Durable plastic casing



Item #437215

Mfg. #330-01-1
Cs Pk 6 x 1 ea
Cs Wt 0.38 lb

Sold in case pack or eaches.



MINI INFRARED THERMOMETER

- -27° to 428°F
- -33° to 220°C
- ±3.6°F/±2.0°C
- D:S: 1:1
- Min/Max/Memory/Lock functions
- Battery included

Item #437217

Mfg. #470-0-8
Cs Pk 1 x 1 ea
Cs Wt 0.25 lb



LASER SIGHTING SLIM-LINE INFRARED THERMOMETER

- Accurately measure surface temperatures within a half second
- -40° to 536°F
- -40° to 280°C
- ±4°F/±2°C
- D:S: 6:1
- LCD backlight for low light areas
- 9V battery and wrist lanyard included
- 2¼" w x 7⅜" h

Item #489271

Mfg. #462-0-8
Cs Pk 6 x 1 ea
Cs Wt 3.00 lb

Sold in case pack or eaches.



DUAL TEMP INFRARED THERMOMETER

- Measures surface and internal temperatures of food
- Min/Max/Memory Lock functions
- 15 second hold
- Auto shut-off
- Lithium button battery

Infrared Features

- -27° to 428°F
- -33° to 220°C
- ±4°F/±2°C
- D:S: 1:1

Probe Features

- -67° to 626°F
- -55° to 330°C
- ±2°F/±1°C

Item #437218

Mfg. #480-0-8
Cs Pk 1 x 1 ea
Cs Wt 1.00 lb



OVEN THERMOMETER

- 2" dial
- 50° to 500°F

Item #482436

Mfg. #THOV-20
Cs Pk 24 x 1 ea
Cs Wt 3.32 lb

Sold in case pack or eaches.

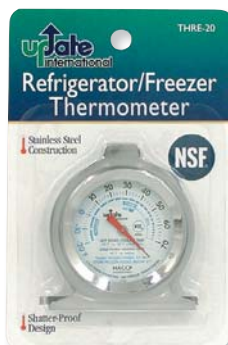

REFRIGERATOR THERMOMETER

- 2" dial
- -20° to 70°F

Item #482438

Mfg. #THRE-20
Cs Pk 24 x 1 ea
Cs Wt 3.32 lb

Sold in case pack or eaches.



FROTHING THERMOMETER

- 1¼" dial with clip
- 30° to 220°F

Item #482433

Mfg. #THFR-17
Cs Pk 24 x 1 ea
Cs Wt 2.44 lb

Sold in case pack or eaches.



KITCHEN

POCKET THERMOMETER

- 1" dial with red sleeve
- 50° to 550°F

Item #482437

Mfg. #THP-550

Cs Pk 24 x 1 ea

Cs Wt 1.75 lb

Sold in case pack or eaches.



CANDY/DEEP FRY THERMOMETER

- 2" dial with clip
- 100° to 400°F

Item #482432

Mfg. #THCF-20D

Cs Pk 24 x 1 ea

Cs Wt 3.19 lb

Sold in case pack or eaches.



KITCHEN

TAYLOR. MECHANICAL LONG RING TIMER

- One-hour mechanical timer with long-ring bell alarm
- Bold numerals are easy to read from a distance

Item #459650

Mfg. #5831

Cs Pk 6 x 1 ea

Cs Wt 1.50 lb

Sold in case pack or eaches.



TAYLOR.

DUAL EVENT DIGITAL TIMER/CLOCK

- 1.5" LCD readout times two events simultaneously
- Hour/minute/second timing – times up to 23 hours, 59 minutes, 59 seconds
- Clock and date feature
- Clip/magnet/stand positioning
- Operates on 1 AAA battery (included)

Item #531835

Mfg. #5828

Cs Pk 6 x 1 ea

Cs Wt 1.32

Sold in case pack or eaches.

LARGE MULTI-STATION DIGITAL TIMER

- Four 99 hour 59 minute timer stations that can be used independently or simultaneously up to 90 decibels
- Four distinctive audio alarms with adjustable volume
- Large LCD (3" x 3") and bright color coded flashing lights
- Memory feature
- Switchable, minutes : seconds or hours : minutes
- Four 1.5V, C heavy-duty batteries (included)
- Optional AC adaptor available



Item #445582

Mfg. #TFS4-0-8

Cs Pk 6 x 1 ea

Cs Wt 6.78 lb

Sold in case pack or eaches.



LONG-RING 60 MINUTE TIMER

- One-handed operation
- Bell rings for 8+ seconds, 70 decibels
- Non-skid feet
- Easy to read dial

Item #437219

Mfg. #TM60-0-8

Cs Pk 6 x 1 ea

Cs Wt 1.50 lb

Sold in case pack or eaches.



DIGITAL TIMER/CLOCK/STOPWATCH

- Large, easy-to-read digital LCD display
- Counts up or down
- 85 decibel alarm
- Memory feature
- 1.5V, AAA alkaline battery (included)

Item #437223

Mfg. #TC6-0-8

Cs Pk 6 x 1 ea

Cs Wt 1.40 lb

Sold in case pack or eaches.



LARGE SINGLE STATION DIGITAL KITCHEN TIMER

- 24 hour
- Flashing red light alarm
- Large 1.2" LCD display
- Non-skid rubber feet
- One-touch start/stop button on top of unit
- Memory feature
- Uses four C batteries (included)

Item #437221

Mfg. #FT24-0-3

Cs Pk 1 x 1 ea

Cs Wt 1.00 lb



SAN JAMAR
Smart → Safe → Sanitary

NSF

SAF-T-ICE® TOTES

- Allows you to transport ice safely, helping you avoid a potential ice-contamination disaster
- Durable, dishwasher safe and unable to nest
- Tri-Grip™ feature provides grab points for secure pouring at any level
- Tougher Handi-Hook™ hangs tote upside down on wire shelving or hanging bracket
- HACCP Hanger™ makes filling totes faster, safer and easier
- Clear Blue
- Cs Pk 2 x 1 ea



Item #	Mfg. #	Description	Cs Wt
395927	SI6000	6 gallon	6.00 lb
537134	SI6100	Shorty, 5 gallon	5.00 lb

Sold in case pack or eaches.

SAN JAMAR
Smart → Safe → Sanitary

NSF

SAF-T-SCOOP® & GUARDIAN SYSTEM™

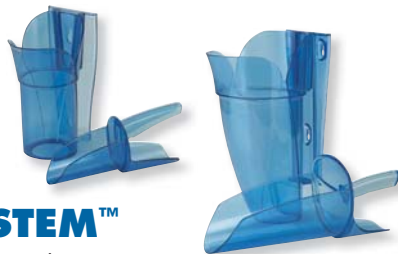

- The first food-safe scoop and protection system
- Scoop design prevents hand contact with ice or other foods during use
- Guardian isolates the scoop from the ice or other foods preventing contamination
- Easy mounting options, inside or outside
- Durable polycarbonate construction is commercial dishwasher safe
- Systems include: Guardian holder with removable drainage cap, set of mounting tools and mounting bracket, 2 wire hanging brackets and 2 suction cups
- For bar and beverage stations the 12-16 oz system has a 12 to 16 oz Saf-T-Scoop
- For ice machines the 64-86 oz system has a 64 to 86 oz Saf-T-Scoop

Item #	Mfg. #	Description	Cs Pk	Cs Wt
453718	SI7000	12-16 oz System	1 x 1 ea	2.00 lb
449099	SI9000	64-86 oz System	1 x 1 ea	3.89 lb
430369▼	SI5500	Scoop Only (6-10 oz)	12 x 1 ea	0.50 lb
460601	SI9500	Scoop Only (64-86 oz)	1 x 1 ea	1.42 lb

▼ *Sold in case pack or eaches.*

SAN JAMAR
Smart → Safe → Sanitary



SAF-T-ICE® SCOOP CADDY

- Ribbed bottom to keep scoop edge dry
- Convenient hinged lid covers scoop, allows easy access
- Easy-Install bracket mounts with self-adhesive strips or screws
- Durable plastic construction
- Dishwasher-safe • Blue

Item #395880

Mfg. #SI2000

Cs Pk 6 x 1 ea

Cs Wt 11.00 lb

Sold in case pack or eaches.

#KP97RD

SAN JAMAR
Smart → Safe → Sanitary

KLEEN-PAIL® SANITIZING PAILS

- Reduces risk of serious cross-contamination from other foodservice pails
- Available in Red for sanitizing solutions, Green for soap solutions
- Formula for a standard sanitizing solution printed on each Red Kleen-Pail
- Made of durable, impact-resistant plastic
- Meets board of health and HACCP mandates for dedicated containers
- Eliminates confusion regarding food storage vs. sanitizing containers



#KP196GN

#KP500

#KP256RD

Item #	Mfg. #	Description	Cs Pk	Cs Wt
395910	KP97RD	3 quart, Red	12 x 1 ea	4.00 lb
395912	KP97GN	3 quart, Green	12 x 1 ea	4.00 lb
395911	KP196RD	6 quart, Red	12 x 1 ea	6.00 lb
395915	KP196GN	6 quart, Green	12 x 1 ea	6.00 lb
397895	KP256RD	8 quart, Red	12 x 1 ea	9.00 lb
537133	KP256GN	8 quart, Green	12 x 1 ea	9.00 lb

Sold in case pack or eaches.

Caddy™ System

- Integrated spray bottle holder, cleaning solution pail & sanitizer spray bottle
- | | | | | |
|--------|-------|--------|----------|---------|
| 430527 | KP500 | System | 1 x 1 ea | 1.14 lb |
|--------|-------|--------|----------|---------|

KITCHEN

BLADERUNNER® SLICER CLEANER

- Reduces danger of hand cuts from slicer blade during cleaning
- Fast, safe way to reduce the risk of cross-contamination at the food slicer
- Reduces risk of breeding bacteria on slicer blades and cutting surfaces
- Provides friction and chemical cleaning in one operation



Item #395868
Mfg. #BR24
Cs Pk 1 x 24 ea
Cs Wt 7.00 lb
Sold in case pack only.



T-STICK® DISPOSABLE THERMOMETER

- Shows burger has been cooked to 160°F as required by USDA
- Verifies proper temperature in seconds
- Easy-to-read sensor turns from white to black when food is at or above 160°F
- Also tests dishwasher rinse water



Item #414870
Mfg. #TST9343
Cs Pk 1/250 ct
Cs Wt 0.50 lb
Sold in case pack only.

SAN JAMAR
Smart → Safe → Sanitary

KITCHEN



SAFETYWRAP® STATION

- Prevents contamination of film or foil
- Combined tools for speed – includes label dispenser
- Side caddies hold pens, cutters or other tools
- Safe and efficient replaceable safety cutting blade
- Holds date label rolls .75" to 3" wide x 3.25" dia
- Holds film or foil roll 12" to 18" wide x 5.1" total dia
- 4 suction cups hold securely to table top or hangs on wire shelf or wall
- Dishwasher safe

NSF

Item #484681
Mfg. #SW1218
Cs Pk 1 x 1 ea
Cs Wt 6.75 lb



SAN JAMAR
Smart → Safe → Sanitary

SAN JAMAR
Smart → Safe → Sanitary



RAPI-KOOL® PLUS

NSF

- Helps chill cooked foods within FDA guidelines
- Chills product from the "inside-out", permitting products to be cooled faster and more evenly
- Innovative Fill-Rite™ design eliminates over filling
- Simply fill with water, screw-on-top and freeze or the wide mouth gives the option to fill with ice so no freezing time required
- Hanging hook for sanitary storage
- No food waste: smooth surface design allows for fast and efficient scraping and clean-up
- Durable polycarbonate plastic is dishwasher safe
- Cs Pk 1 x 1 ea

Item #	Mfg. #	Description	Cs Wt
515534	RCU64V2	64 oz	1.10 lb
516304	RCU128V2	128 oz	1.52 lb



SAFETY MATE® INSTA CHILL

- Rapidly chills food to 41°F through the temperature danger zone
- Molded in fill line prevents over filling
- Molded in hook allows unit to hang from wire shelving
- Tethered cap to prevent loss
- Easy grip side handle for ergonomic motion
- Wide mouth provides option to fill with ice
- Dishwasher safe polycarbonate
- Cs Pk 1 x 1 ea

TRAEX
A Leary FOODSERVICE Company

NSF

Item #	Mfg. #	Description	Cs Wt
482580	7022	2 liter, 4" dia x 15½" long	1.60 lb
482581	7024	4 liter, 4" dia x 23½" long	2.35 lb

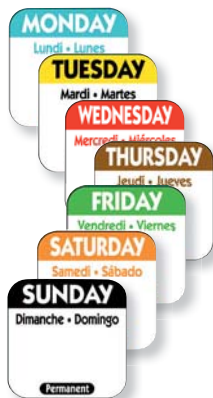

TRILINGUAL PERMANENT LABELS



- 1" x 1" Day of the Week
- 1000 labels per roll
- Cs Pk 1/1000 ct
- Cs Wt 0.28 lb

Item #	Mfg. #	Description
466873	P101R	Monday
466874	P102R	Tuesday
466875	P103R	Wednesday
466876	P104R	Thursday
466877	P105R	Friday
466878	P106R	Saturday
466879	P107R	Sunday

Sold in case pack only.

TRILINGUAL REMOVABLE LABELS

- 1" x 1" Day of the Week
- 1000 labels per roll
- Cs Pk 1/1000 ct
- Cs Wt 0.28 lb

Item #	Mfg. #	Description
466888	R101R	Monday
466889	R102R	Tuesday
466890	R103R	Wednesday
466891	R104R	Thursday
466892	R105R	Friday
466893	R106R	Saturday
466894	R107R	Sunday

Sold in case pack only.



LABELOCKER™ DISPENSERS & LABEL KITS

- Durable plastic dispenser
- 7 rolls (one for each day of the week)
- 1000 labels per roll

Item #	Mfg. #	Description	Cs Pk	Cs Wt
467016	P1KIT	w/Permanent Labels, 1"	1 x 1 set	3.00 lb
467017	R1KIT	w/Removable Labels, 1"	1 x 1 set	3.00 lb
481153	R2KIT	w/Removable Labels, 2"	1 x 1 set	4.00 lb
467018	D1KIT	w/Dissolvable Labels, 1"	1 x 1 set	3.00 lb

Sold in case pack only.

Dispensers only

467006	LL7R-1	Holds 1" Rolls	1 x 1 ea	1.00 lb
481152	LL7R-2	Holds 2" Rolls	1 x 1 ea	3.00 lb



TRILINGUAL PERMANENT LABELS

- ¾" dia Day of the Week
- 2000 labels per roll
- Cs Pk 1/2000 ct
- Cs Wt 0.34 lb

Item #	Mfg. #	Description
466866	P7501R	Monday
466867	P7502R	Tuesday
466868	P7503R	Wednesday
466869	P7504R	Thursday
466870	P7505R	Friday
466871	P7506R	Saturday
466872	P7507R	Sunday

Sold in case pack only.

DISPENSER

- Plexiglas
- Holds 7 - ¾" & 1" rolls (not included)

Item #467008

Mfg. #DISP7R-1
Cs Pk 1 x 1 ea
Cs Wt 1.50 lb



Saddle bags and labels sold separately



"PRODUCT" REMOVABLE LABELS

- 1" x 2"
- 500 labels per roll

Item #466911

Mfg. #RP12R
Cs Pk 1/500 ct
Cs Wt 0.72 lb

Sold in case pack only.



"PRODUCT" DISSOLVING LABELS

- 1" x 2"
- 500 labels per roll

Item #466938

Mfg. #DP12R
Cs Pk 1/500 ct
Cs Wt 0.28 lb

Sold in case pack only.



"SHELF LIFE" REMOVABLE LABELS

- 2" x 4"
- 500 labels per roll

Item #466924

Mfg. #RSL24R
Cs Pk 1/500 ct
Cs Wt 1.25 lb

Sold in case pack only.



"USE BY" DISSOLVING LABELS

- 2" x 3"
- 250 labels per roll

Item #466939

Mfg. #DSL23R
Cs Pk 1/250 ct
Cs Wt 0.36 lb

Sold in case pack only.

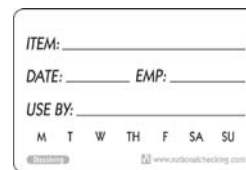

"ITEM/PREP/USE" REMOVABLE LABELS

- 2" x 4"
- 500 labels per roll



Item #466925

Mfg. #RIPU24R
Cs Pk 1/500 ct
Cs Wt 1.25 lb

Sold in case pack only.

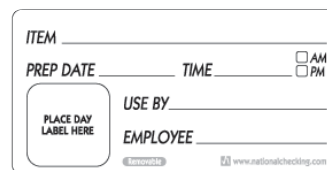

TRILINGUAL "USE FIRST" REMOVABLE LABELS

- 2" dia
- 500 labels per roll

Item #466895

Mfg. #RUF2R
Cs Pk 1/500 ct
Cs Wt 0.40 lb

Sold in case pack only.



DISSOLVEMARK™ "DAY-OF-WEEK" LABELS

- Biodegradable labels
- Easily rinses away
- Specify day
- Adheres to plastic and stainless steel containers
- Cs Pk 12/250 ct
- Cs Wt 3.12 lb

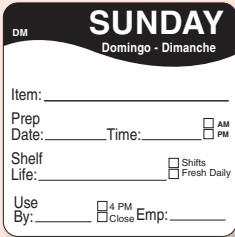

DissolveMark™ 2" x 2" - "Use By" Trilingual Labels

Item #	Mfg. #	Description
457993	1122131	Monday
457996	1122132	Tuesday
457997	1122133	Wednesday
458000	1122134	Thursday
458002	1122135	Friday
458005	1122136	Saturday
458007	1122137	Sunday

Sold in case pack only.



DissolveMark™ Benefits

- Easy to remove, dissolves in any water temperature
- Safe for freezer
- Great for use in these areas: dry storage, cooler and freezer, food prep and dishwashing
- Avoid high moisture areas, steam and condensation

DISSOLVEMARK™ "SHELF LIFE" & "BLANK" LABELS

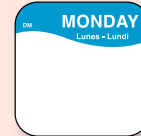
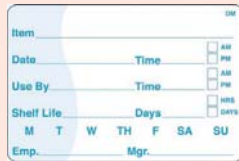
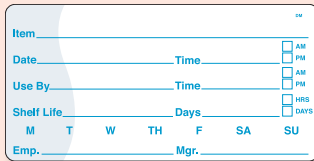

DissolveMark™ Shelf Life

- Dissolves after 12-30 seconds of water is applied

Item #	Mfg. #	Description	Cs Pk	Cs Wt
482014	110105	1" x 2"	12/500 ct	7.44 lb
481951	110084	2" x 4"	12/125 ct	3.24 lb
481952	110116	2" x 3"	12/125 ct	9.12 lb

Sold in case pack only.

DissolveMark™ Trilingual Blank Labels

- ¾" x ¾"
- Cs Pk 12/1000 ct
- Cs Wt 1.84 lb

Item #	Mfg. #	Description
482000	1100371	Monday
482001	1100372	Tuesday
482002	1100373	Wednesday
482003	1100374	Thursday
482004	1100375	Friday
482032	1100376	Saturday
482006	1100377	Sunday

Sold in case pack only.

KITCHEN

DOT BOX DISPENSING SYSTEMS

- 7 slot dispenser with 1" x 1" Day-Of-Week labels



With DissolveMark™ Labels

Item #453638

Mfg. #111181
Cs Pk 1 x 7/500 ct
Cs Wt 14.59 lb

Sold in case pack only.



With MoveMark™ Labels

Item #453637

Mfg. #111183
Cs Pk 1 x 7/1000 ct
Cs Wt 2.35 lb

Sold in case pack only.



DURAMARK™ PERMANENT LABELS

- Aggressive adhesive stays on any surface
- Use on disposable containers, boxes and portion bags
- Moisture resistant
- Safe for freezer



Day-of-the-Week Circle Labels

- Trilingual
- ¾" dia, permanent
- Cs Pk 12/2000 ct
- Cs Wt 2.76 lb

Item #	Mfg. #	Description
481993	1100591	Monday
481994	1100592	Tuesday
481995	1100593	Wednesday
481996	1100594	Thursday
481997	1100595	Friday
481998	1100596	Saturday
481999	1100597	Sunday

Sold in case pack only.

Day-of-the-Week Circle Labels

- Trilingual - half blank
- 1" dia, permanent
- Cs Pk 12/1000 ct
- Cs Wt 3.36 lb

Item #	Mfg. #	Description
481981	1103411	Monday
481983	1103412	Tuesday
481986	1103413	Wednesday
481988	1103414	Thursday
481989	1103415	Friday
481991	1103416	Saturday
481992	1103417	Sunday

Sold in case pack only.

PRINTED LABEL TAPE

- Preprinted with Item, Time, Prepared By and Date
- Ideal for label and rotation
- Text repeats every 3¾" providing up to 540 labels
- Removes easily even after storing, heating or cooling

Item #414170

Mfg. #FSPT-2
Cs Pk 1 x 4 ct
Cs Wt 3.70 lb

Sold in case pack only.



MOVEMARK™ OCTAGON LABELS

- Trilingual, 1", removable
- Cs Pk 12/1000 ct
- Cs Wt 3.60 lb

Item #	Mfg. #	Description
482007	1100601	Monday
482008	1100602	Tuesday
482009	1100603	Wednesday
482010	1100604	Thursday
482011	1100605	Friday
482012	1100606	Saturday
482013	1100607	Sunday

Sold in case pack only.



LABEL DISPENSERS

Labels not included

Plexiglass Dispenser

Holds 3/4" x 3/4" and 1" x 1" labels

Item #453607

Mfg. #110501

Cs Pk 1 x 1 ea

Cs Wt 1.76 lb

7 Slot Plastic Rack

Holds 3/4" x 3/4", 1" x 1" and

1" x 1 1/2" labels

Item #453631

Mfg. #110493

Cs Pk 1 x 1 ea

Cs Wt 1.73 lb

7 Slot Metal Rack

Holds 3/4" x 3/4", 1" x 1" and

1" x 1 1/2" labels

Item #453616

Mfg. #110806

Cs Pk 1 x 1 ea

Cs Wt 2.09 lb



MACHINE APPLIED LABELS

- Cs Pk 8/1000 ct
- Cs Wt 5.75 lb

DM3 1 Line Marker Labels

Item # Mfg. # Description

453578	1104091	Monday
453579	1104092	Tuesday
453580	1104093	Wednesday
453583	1104094	Thursday
453584	1104095	Friday
453585	1104096	Saturday
453586	1104097	Sunday
458044	110422	Fluorescent Pink
453573	110418	1 Line, White
453636	110428	Use By Labels

Sold in case pack only.

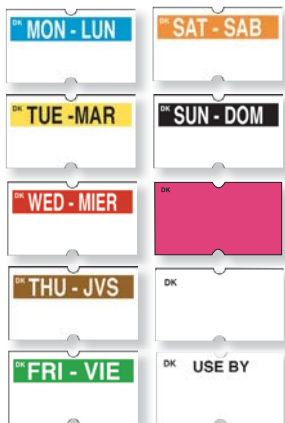

DM3 LABELING GUN

- Date coding
- Uses 1 line marker labels

Item #453635

Mfg. #110767

Cs Pk 1 x 1 ea

Cs Wt 1.00 lb



MANI-KARE® BANDAGES

- Bandages are made from hospital quality, flexible cloth
- Easily visible bright blue color
- Handy storage box makes bandages easy to find and keeps them clean
- Value pack: 2 boxes of 50 strips; 1 box of 40 small fingertip; 1 box of 25 large fingertip; 1 box of 40 knuckle and 1 box of 25 patches



SAN JAMAR
Smart → Safe → Sanitary

Item #	Mfg. #	Description	Cs Pk	Cs Wt
432342	MK0906	Value Pack, Assorted Sizes	1 x 6 ea	4.80 lb
445402	MK0901	Strips Only, 7/8" x 3"	6 x 50 ea	1.80 lb

Sold in case pack or eaches.

FIRST AID KITS

- Supplies necessary for administering emergency first aid
- OSHA compliant
- Easily refilled



FAK 25 Medium First Aid Kit

Contents: ten antiseptic wipes (2 boxes); twenty-five 1" x 3" fabric (2 boxes); twenty fingertip foam; twenty knuckle foam; five 3" x 3" gauze pads (2 boxes); one 5" x 9" trauma pad; one 2" trauma pad; one 2" gauze roll; one 40" sling; one 1" x 5 yd tape; ten single burn cream; six burn gel; 4 1/2" scissors; 3" tweezers; an AMA first aid book and one pair vinyl gloves. Kit dimensions: 9" x 11 1/4".

Item #481566

Mfg. #113720

Cs Pk 1 x 1 ea

Cs Wt 6.95 lb



FAK 50 Large First Aid Kit

Contents: twenty alcohol pads; ten antiseptic wipes (2 boxes); one bottle eye wash (1 oz); twenty-five 1" x 3" foam bandages (2 boxes); one 5 yd elastic wrap; twenty fingertip foam; twenty knuckle foam; one finger cot (box of 50); ten 2" mole skin; five 2" x 2" gauze pads; five 3" x 3" gauze pads; one 5" x 9" trauma pad; one 2" gauze roll; one 3" gauze roll; one 40" sling; one 1" x 5 yd tape; one 1/2" x 10 yd tape; ten single burn cream; ten antibiotic ointment; six burn gel; 4 1/2" scissors; 3" tweezers; an AMA first aid book and one pair vinyl gloves. Kit dimensions: 13" x 14".

Item #459732

Mfg. #113419

Cs Pk 1 x 1 ea

Cs Wt 5.78 lb



BURN CARE KIT

- Great for first aid for burns and preventing long term injury

Contents: one 3" x 5 yd latex free bandage wrap; one 3" conforming gauze roll bandage; one 1" x 5 yd first aid tape roll; one 4" x 16" Water-Jel® burn dressing; two 4" x 4" Water-Jel® burn dressings; 2 pair of exam quality gloves and 4 1/2" nickel plated scissors. Comes in a convenient plastic carrying case.



Burn Care Kit

Item #482625

Mfg. #113786

Cs Pk 1 x 1 ea

Cs Wt 1.50 lb

KITCHEN

FOOD STORAGE BOXES



Clear Camwear® Polycarbonate

- Tough Camwear® polycarbonate stands up to tough treatment, withstands temperature extremes from -40° to 210°F
- Smooth surfaces are easy-to-clean

Item #	Mfg. #	Description	Cs Pk	Cs Wt
Boxes - 18" x 26"				
380076	18263CW-135	3½" deep, 5.0 gal	6 x 1 ea	21.92 lb
380083	18266CW-135	6" deep, 8.75 gal	6 x 1 ea	30.05 lb
380090	18269CW-135	9" deep, 13.0 gal	4 x 1 ea	27.03 lb
380068	182615CW-135	15" deep, 22.0 gal	3 x 1 ea	31.76 lb
Boxes - 12" x 18"				
379787	12183CW-135	3½" deep, 1.75 gal	6 x 1 ea	12.14 lb
379805	12186CW-135	6" deep, 3.0 gal	6 x 1 ea	16.02 lb
379821	12189CW-135	9" deep, 4.75 gal	6 x 1 ea	20.44 lb
Covers				
380099	1826CCW-135	Flat, 18" x 26"	6 x 1 ea	16.01 lb
379829	1218CCW-135	Flat, 12" x 18"	6 x 1 ea	7.88 lb
Colander - Fits 18" x 26" x 6" and deeper				
487289	1826CLRCW	5" deep	6 x 1 ea	27.95 lb



NSF

White Polyethylene

- Economical, impact, stain and chemical resistant
- Withstands temps from -40° to 160°F
- Stackable and dishwasher safe
- Snap-tight covers available for all sizes
- Cs Pk 6 x 1 ea

NSF

Item #	Mfg. #	Description	Cs Wt
Boxes - 18" x 26"			
380078	18263P-148	3½" deep, 5.0 gal	16.22 lb
380087	18266P-148	6" deep, 8.75 gal	29.20 lb
380097	18269P-148	9" deep, 13.0 gal	31.81 lb
380074	182615P-148	15" deep, 22.0 gal	27.30 lb
Boxes - 12" x 18"			
379818	12186P-148	6" deep, 3.0 gal	12.53 lb
379825	12189P-148	9" deep, 4.75 gal	16.44 lb
Covers			
380103	1826CP-148	Flat, 18" x 26"	13.18 lb
379842	1218CP-148	Flat, 12" x 18"	5.68 lb



KITCHEN

STORESAFE® FOOD ROTATION LABELS

- 2" x 3" labels leave no sticky residue, eliminate scraping and save operators time and money
- Both adhesive and label dissolve completely
- Easy and safe for labeling products in the cooler, freezer, dry storage or in food pan carriers
- 250 labels/roll

Item #401468

Mfg. #23SLB250
Cs Pk 24/1/250 ct
Cs Wt 10.61 lb

Sold in case pack or eaches.



Not Available via FedEx®.

NSF



CAMCRISPER® VEGETABLE CRISPER

- A self-contained system for storing, washing and transporting bulk produce
- Clear polycarbonate cover slides open for easy access
- Threaded faucet drain and polycarbonate drain shelf (included) eliminate standing water
- Polyethylene crisper bin won't rust, corrode or transfer odors or flavors
- 3" casters (2 fixed, 2 swivel)
- 32 gal capacity, 22"w x 24"d x 23"h

Item #380609

Mfg. #CC32-148
Cs Pk 1 x 1 ea
Cs Wt 28.67 lb



FRESHWAY® VEGETABLE CRISPER

- Retains the crispness and freshness of fresh cut fruits and vegetables
- Extends the shelf life by retarding oxidation
- Does not contain sulfites - only FDA accepted ingredients (citric acid, calcium chloride, erythorbic acid, tri-calcium phosphate, mono-calcium phosphate)

1 lb Container

Item #431912

Mfg. #FW12
Cs Pk 12/1 lb
Cs Wt 14.00 lb

5 lb Container

Item #431913

Mfg. #FW65
Cs Pk 6/5 lb
Cs Wt 33.00 lb

Sold in case pack only.



Camwear® Polycarbonate with Seal Covers



Polyethylene with Color Coded Covers



4 qt/3 pack 6 qt/2 pack

CAMSQUARE® FOOD CONTAINERS

- Choose from unbreakable, crystal clear Camwear® polycarbonate or economical white polyethylene – both stack and nest easily and are dishwasher safe
- Color coded snap-tight covers with tabs fit both Camwear® and Poly Square containers

Item # Mfg. # Capacity/Graduation Color Cs Pk Cs Wt

Clear Camwear® Polycarbonate Containers

380331	2SFSCW-135	2 qt/Red Graduation Marks	6 x 1 ea	3.34 lb
380422	4SFSCW-135	4 qt/Red Graduation Marks	6 x 1 ea	5.28 lb
380596	6SFSCW-135	6 qt/Red Graduation Marks	6 x 1 ea	7.00 lb
380599	8SFSCW-135	8 qt/Red Graduation Marks	6 x 1 ea	8.41 lb
379863	12SFSCW-135	12 qt/Red Graduation Marks	6 x 1 ea	11.94 lb
380105	18SFSCW-135	18 qt/Red Graduation Marks	6 x 1 ea	19.03 lb
380136	22SFSCW-135	22 qt/Red Graduation Marks	6 x 1 ea	25.58 lb

White Poly Containers – Graduation color on container matches color coded covers

380335	2SFSP-148	2 qt/Kelly Green Graduation Marks	6 x 1 ea	2.43 lb
380425	4SFSP-148	4 qt/Kelly Green Graduation Marks	6 x 1 ea	4.49 lb
380597	6SFSP-148	6 qt/Winter Rose Graduation Marks	6 x 1 ea	5.66 lb
380600	8SFSP-148	8 qt/Winter Rose Graduation Marks	6 x 1 ea	7.40 lb
379871	12SFSP-148	12 qt/Midnight Blue Graduation Marks	6 x 1 ea	9.11 lb
380107	18SFSP-148	18 qt/Midnight Blue Graduation Marks	6 x 1 ea	15.02 lb
380137	22SFSP-148	22 qt/Midnight Blue Graduation Marks	6 x 1 ea	20.02 lb

Color Coded Covers (for both Camwear® and Poly Containers)

380050	SFC2-452	Fits 2 & 4 qt/Kelly Green	6 x 1 ea	1.26 lb
380051	SFC6-451	Fits 6 & 8 qt/Winter Rose	6 x 1 ea	1.64 lb
380049	SFC12-453	Fits 12, 18 & 22 qt/Midnight Blue	6 x 1 ea	2.53 lb

Seal Covers for Camwear® Containers Only

502091	SFC2SCPP	Fits 2 & 4 qt	6 x 1 ea	1.16 lb
502094	SFC6SCPP	Fits 6 & 8 qt	6 x 1 ea	1.64 lb
502423	SFC12SCPP-190	Fits 12, 18 & 22 qt	6 x 1 ea	2.55 lb

Sold in case pack or eaches.

CASH & CARRY – Translucent Poly Containers With Covers

472120	2SFSPPSW3190	3 Pack, 2 qt/Kelly Green	4 x 3 ea	8.00 lb
472121	4SFSPPSW3190	3 Pack, 4 qt/Kelly Green	4 x 3 ea	12.00 lb
472122	6SFSPPSW2190	2 Pack, 6 qt/Winter Rose	6 x 2 ea	15.00 lb
472123	8SFSPPSW2190	2 Pack, 8 qt/Winter Rose	6 x 2 ea	18.00 lb

Sold in case pack only.

PAIL WITH BAIL HANDLE

- Polyethylene construction
- 22 quart capacity is great for mixing, storing or transporting
- Durable, stain resistant and dishwasher safe
- Natural White
- Cs Pk 6 x 1 ea



Item #	Mfg. #	Description	Cs Wt
380108	PWB22-148	Pail	14.42 lb
380134	RFSC12-148	Cover	3.80 lb

Sold in case pack or eaches.

FREEZER DRAIN BOX SET

- Freezer grade, FDA approved, high density polyethylene
- 21¼" x 15¾" x 7"d - set includes drain box with ¼" dia holes, freezer box and cover
- White

Item #389713

Mfg. #DBF77
Cs Pk 1 x 1 set
Cs Wt 7.00 lb



INGREDIENT BINS

- Transparent polycarbonate slide-back lids
- White polyethylene bin body – FDA accepted – easy to clean
- Heavy duty 3" casters (2 fixed, 2 swivel) are bolted into molded-in steel plates – will not pull out or fall off
- Easily store under work tables
- Cs Pk 1 x 1 ea

Item #	Mfg. #	Capacity/Dimensions	Cs Wt
380063	IB32-148	32 gal, 22"w x 24"l x 23"h	25.34 lb
Slant Top			
448526	IBS20-148	21 gal, 13"w x 29½"l x 28"h	27.48 lb
368899	IBS27-148	27 gal, 16⅝"w x 29⅞"l x 29"h	30.71 lb
389263	IBS37-148	37 gal, 21½"w x 29½"l x 28"h	28.00 lb

#IBS20-148
Scoop sold separately.
S-Hook included.



Not Available via FedEx®.



#IBS27-148
Scoop sold separately.
S-Hook included.

KITCHEN

ROUND STORAGE CONTAINERS

- Use to store ingredients or transport ready-to-serve or partially prepared foods
- Round shape promotes proper air circulation around the container
- Easy to read imprinted graduations on the outside for inventory at a glance
- Molded-in holes in the handles for quick and sanitary drying
- Snap on covers fit tightly, yet can be easily removed

Translucent

- Translucent polypropylene is tough and dishwasher safe
- Withstands temperatures of -40° to +160°F
- Contents are easily visible



Item #	Mfg. #	Capacity	Cs Pk	Cs Wt
Translucent Containers				
380121	RFS2PP-190	2 qt	12 x 1 ea	3.80 lb
380124	RFS4PP-190	4 qt	12 x 1 ea	5.80 lb
380128	RFS6PP-190	6 qt	12 x 1 ea	8.16 lb
380132	RFS8PP-190	8 qt	12 x 1 ea	11.34 lb
380110	RFS12PP-190	12 qt	6 x 1 ea	7.26 lb
380113	RFS18PP-190	18 qt	6 x 1 ea	9.84 lb
380119	RFS22PP-190	22 qt	6 x 1 ea	13.12 lb

Translucent Covers

380022	RFSC2PP-190	Fits 2 & 4 qt	12 x 1 ea	1.39 lb
380024	RFSC6PP-190	Fits 6 & 8 qt	12 x 1 ea	2.20 lb
380020	RFSC12PP-190	Fits 12, 18 & 22 qt	6 x 1 ea	3.60 lb

Sold in case pack or eaches.



Translucent

Covers sold separately.

Polyethylene

- Economical white polyethylene is dishwasher safe
- Withstands temperatures of -40° to +160°F



Item #	Mfg. #	Capacity	Cs Pk	Cs Wt
White Poly Containers				
380116	RFS2-148	2 qt	12 x 1 ea	3.96 lb
380122	RFS4-148	4 qt	12 x 1 ea	6.16 lb
380126	RFS6-148	6 qt	12 x 1 ea	8.76 lb
380130	RFS8-148	8 qt	12 x 1 ea	11.57 lb
380109	RFS12-148	12 qt	6 x 1 ea	7.49 lb
380111	RFS18-148	18 qt	6 x 1 ea	10.24 lb
380118	RFS22-148	22 qt	6 x 1 ea	13.61 lb

White Poly Covers

380021	RFSC2-148	Fits 2 & 4 qt	12 x 1 ea	1.43 lb
380023	RFSC6-148	Fits 6 & 8 qt	12 x 1 ea	2.20 lb
380134	RFSC12-148	Fits 12, 18 & 22 qt	6 x 1 ea	3.80 lb

Sold in case pack or eaches.



Polyethylene

Camwear®

Camwear®

- Crystal clear, virtually unbreakable polycarbonate
- Withstands temperatures of -40° to +210°F
- Stain-resistant to food acids and oils



Item #	Mfg. #	Capacity	Cs Pk	Cs Wt
Clear Camwear Containers				
380025	RFSCW1-135	1 qt	12 x 1 ea	4.37 lb
380029	RFSCW2-135	2 qt	12 x 1 ea	6.56 lb
380031	RFSCW4-135	4 qt	12 x 1 ea	10.49 lb
380032	RFSCW6-135	6 qt	12 x 1 ea	12.05 lb
380033	RFSCW8-135	8 qt	12 x 1 ea	15.58 lb
380026	RFSCW12-135	12 qt	6 x 1 ea	11.52 lb
380028	RFSCW18-135	18 qt	6 x 1 ea	15.89 lb
380030	RFSCW22-135	22 qt	6 x 1 ea	19.16 lb

Clear Camwear Covers

380034	RFSCWC1-135	Fits 1 qt	12 x 1 ea	1.25 lb
380037	RFSCWC2-135	Fits 2 & 4 qt	12 x 1 ea	2.72 lb
380038	RFSCWC6-135	Fits 6 & 8 qt	12 x 1 ea	3.47 lb
380035	RFSCWC12-135	Fits 12, 18 & 22 qt	6 x 1 ea	4.20 lb

Sold in case pack or eaches.

STORING REFRIGERATED FOOD

Food	Max. Storage Temp °F	Max. Storage Period
Dairy Products		
Milk (fluid)	40	3 days
Butter	40	2 weeks in waxed cartons
Cheese (hard)	40	6 months tightly covered
Cheese (soft)	40	7 days in tightly covered cont.
Ice Cream and ices	10	3 months in original covered cont.
Eggs	45	7 days
Fish		
Fresh	36	20 days loosely wrapped
Shell Fish	36	5 days in covered cont.
Fruits		
Peaches, Plums, Berries	50	7 days unwashed
Apples, Pears, Citrus	50-70	2 weeks, original cont.
Poultry	36	7 days
Meat		
Ground	38	2 days
Fresh Meat Cuts	38	6 days
Liver and Variety Meats	38	2 days
Cold Cuts (sliced)	38	6 days
Cured Bacon	38	1-4 weeks
Ham (tender cured)	38	1-6 weeks
Ham (canned)	38	6 weeks, original cont.
Dried Beef	38	6 weeks
Vegetables		
Leafy	45	7 days
Potatoes, Onions, Root vegetables	50-70	7-30 days, dry in ventilated cont.

SPARTA® SPECTRUM® ASSORTED CUTTING BOARD BRUSHES

- The Spectrum line reduces the risk of cross contamination and ensures proper sanitation
- Color-coded so employees can segregate brushes by task or work zone
- Assortment pack includes six brushes, color-coded for HACCP zone identification: Blue - seafood, Green - produce, Red - raw meats, Tan - cooked meat, White - dairy, and Yellow - poultry
- 6" long x 2½" wide w/polyester bristles



Cutting board not included



Item #380799
Mfg. #4134200
Cs Pk 1 x 1 set
Cs Wt 3.00 lb
Sold in case pack only.

SAF-T-GRIP® BOARD-MATE® CUTTING BOARD SAFETY MAT

- Stops cutting board from sliding on virtually any work surface
- Reduces knife hazards
- Dishwasher safe
- 16" x 22"

Item #399224
Mfg. #CBM1622
Cs Pk 12 x 1 ea
Cs Wt 1.42 lb
Sold in case pack or eaches.



CUTTING BOARDS

- Polyethylene won't chip, crack, peel or warp
- Easy to clean
- Dishwasher safe
- White
- Cs Pk 6 x 1 ea

Item #	Mfg. #	Description	Cs Wt
476680	CB1218WA	12" x 18"	22.00 lb
476682	CB1520WA	15" x 20"	31.00 lb
476684	CB1824WA	18" x 24"	45.00 lb

Sold in case pack or eaches.



CUTTING BOARD

- White polyethylene
- Non-porous surface will not stain or absorb juices
- 15" x 20" x ½" thick

Item #482293
Mfg. #CB-1520
Cs Pk 6 x 1 ea
Cs Wt 35.00 lb
Sold in case pack or eaches.

KITCHEN

CUT-N-CARRY® CUTTING BOARDS & STAND

- Designed to combat cross contamination
- Durable, tough, long-lasting - will not chip, crack, peel or warp
- Revolutionary hook promotes sanitary transport
- Dishwasher safe, non-porous, non-absorbent, stain resistant, won't dull knives
- Boards bear permanent NSF logo for easy ID



Item #	Mfg. #	Description	Cs Pk	Cs Wt
397877	CB121812WH	12" x 18" x ½", White	6 x 1 ea	22.00 lb
397884	CB152012WH	15" x 20" x ½", White	6 x 1 ea	32.00 lb
397986	CB152012RD	15" x 20" x ½", Red	6 x 1 ea	32.00 lb
397887	CB182412WH	18" x 24" x ½", White	6 x 1 ea	43.00 lb
397889	CB182412BL	18" x 24" x ½", Blue	6 x 1 ea	43.00 lb
397892	CB182412GN	18" x 24" x ½", Green	6 x 1 ea	43.00 lb
397894	CB182412YL	18" x 24" x ½", Yellow	6 x 1 ea	43.00 lb
397893	CB182412RD	18" x 24" x ½", Red	6 x 1 ea	43.00 lb
397644*	CB1218KC	12" x 18" x ½", Combo	1 x 1 set	22.00 lb
397678*	CB1520KC	15" x 20" x ½", Combo	1 x 1 set	32.00 lb
397684*	CB1824KC	18" x 24" x ½", Combo	1 x 1 set	43.00 lb
395922	KLRST	Stainless Steel Storage Stand	1 x 1 ea	5.00 lb

Sold in case pack or eaches.

Sold in case pack only.

*Combo packs contain six boards – one each of Beige, Red, Green, Yellow, Blue and White, along with one Kolor-Cut Wall chart.

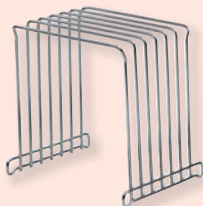

Stand (sold separately)



HAND HELD SHARPENER

- With just two strokes, the blade is sharpened and then honed to an exceptionally sharp edge
- Stable platform design and secure grip promote safe use

Item # 423863
Mfg. # E5698
Cs Pk 1 x 1 ea
Cs Wt 0.30 lb



MAGNETIC KNIFE HOLDERS

Wood Base Bar, 12"
Item #457414
Mfg. #2912W
Cs Pk 1 x 1 ea
Cs Wt 1.50 lb

Wood Base Bar, 18"
Item #457426
Mfg. #2918W
Cs Pk 1 x 1 ea
Cs Wt 1.80 lb



ALADDIN KNIFE SHARPENER

Item #469398
Mfg. #E5699
Cs Pk 1 x 1 ea
Cs Wt 0.70 lb



SHARPENING SYSTEM

- 3-way sharpening system, 8"

Item # 423862
Mfg. #MH-308
Cs Pk 1 x 1 ea
Cs Wt 4.00 lb



PREMIUM HONING OIL

• 16 oz
Item # 431474
Mfg. #MHOIL
Cs Pk 1 x 1 ea
Cs Wt 0.50 lb

KITCHEN



HEAVY DUTY ELECTRIC KNIFE SHARPENER

- "Easy track" guidance system with ABS plastic guides for precise edge control
- Stainless steel construction
- Slow speed wheel to prevent "burning" of knife blades
- Thermal motor protection against overload
- Lighted rocker switch indicates when motor is running
- 115V
- Made in USA

Item #369994
Mfg. #39600
Cs Pk 1 x 1 ea
Cs Wt 11.00 lb



KNIFE SHARPENER

- Two grinding wheels (fine/coarse), one stropping wheel
- Grinds at 18-22° angles
- Stropping wheel operates in reverse direction allowing for a more efficient removal of burrs and polishing of the blade
- Magnetized drawer under grinding wheel captures metal shavings
- Limited one year warranty
- 120V

Item #459654
Mfg. #WKS800
Cs Pk 1 x 1 ea
Cs Wt 24.00 lb





FIRM GRIP™ GARNISHÉ SET

- 9 pc set includes nylon case, zester/lemon peeler, fluted melon baller, tomato stem corer, melon baller, garnishing knife, double pastry cutter, butter curler, straight peeler and apple corer
- Ergonomic, soft grip handles
- Non-slip grips provide comfort and safety

Item #431473

Mfg. #E5600-9

Cs Pk 1 x 1 set

Cs Wt 1.60 lb



KNIFE RACK

- Stainless steel
- 10 slots to hold knives and steels

Item #484792

Mfg. #KR-1212

Cs Pk 12 x 1 ea

Cs Wt 33.00 lb

Sold in case pack and eaches.



KNIFE RACK

- One knife rack that does it all
- Corrosion resistant stainless steel
- Holds 8 chef's knives, plus 2 smaller knives, 1 steel and scissors
- NSF dishwasher safe insert will not dull knives
- Knife rack skirt protects the knives and operators from accidents
- V-slot design holds knives upright and more securely
- Made in USA

Item #477056

Mfg. #KR-699

Cs Pk 1 x 1 ea

Cs Wt 3.50 lb



KNIFE RACK

- ABS plastic construction
- Holds 12 knives, 1 cleaver and 1 sharpening steel
- Mounts to counter or wall, screws included

Item #439368

Mfg. #PKR-1

Cs Pk 1 x 1 ea

Cs Wt 3.02 lb

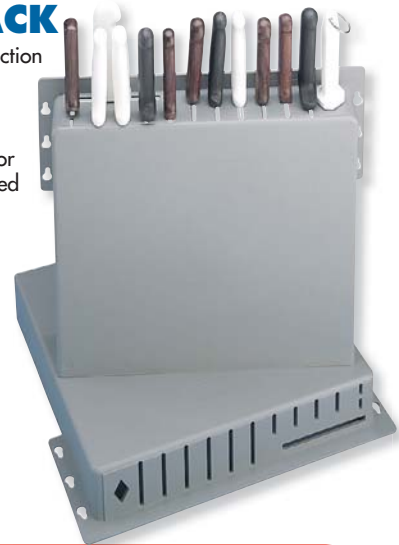

KITCHEN

CUT RESISTANT GLOVES

- Outstanding cut resistance
- Now with antimicrobial properties
- FDA & USDA approved materials
- Comfortable, durable, flexible & ambidextrous
- Unique elastic over banding in cuff for comfort and safety
- Washable and bleach-safe
- Cs Pk 12 x 1 ea

UltimateSHIELD

- Stainless steel in sheath core of polyethylene and polyester filament yarn – offers maximum cut resistance and durability without steel wire fragmentation

PerformanceSHIELD

- Spectra with industrial polyester in the outer cover for durability and great feel, along with exceptional cut resistance



VICTORINOX
SWISS ARMY



Item #	Mfg. #	Description	Cs	Wt
UltimateSHIELD Gloves:				
379940	86003	Medium, White w/Green Trim	2.40	lb
379941	86004	Large, White	2.50	lb
PerformanceSHIELD Gloves:				
431284	86502	Small, White w/Red Trim	1.50	lb
379942	86503	Medium, White w/Green Trim	1.90	lb
379943	86504	Large, White	2.20	lb
431285	86505	X-Large, White w/Black Trim	1.50	lb

Sold in case pack or eaches.

KITCHEN SHEARS

- Black nylon handle
- Forged 3" stainless steel blades

Item #400087

Mfg. #45896

Cs Pk 1 x 1 set

Cs Wt 0.60 lb



VICTORINOX
SWISS ARMY



SHARPENING STONE

- Quick cut combination fine and coarse
- 8" x 2" x 1"

Item #402218

Mfg. #41998

Cs Pk 1 x 1 ea

Cs Wt 1.00 lb

VICTORINOX
SWISS ARMY



BRIEFCASE STYLE CUTLERY CASE

- Holds 10 knives, 3 pocket thermometers, 5 gadgets, a full chef's uniform & 5 miscellaneous slots
- Detachable shoulder strap

Item #483540
Mfg. #SCWH-9
Cs Pk 1 x 1 ea
Cs Wt 0.75 lb



KNIFE STORAGE MAGNETIC BAR

- 18" long

Item #483521
Mfg. #5518
Cs Pk 6 x 1 ea
Cs Wt 3.20 lb
Sold in case pack or eaches.



5600 SERIES PROFESSIONAL CUTLERY

- Well balanced and durable
- Non-slip ergonomic polypropylene handles w/antimicrobial protection
- High carbon stainless steel blades
- White handles



Item #	Mfg. #	Description	Cs Pk	Cs Wt
Butcher Knives				
483475	W5625-10	10" Blade	6 x 1 ea	4.25 lb
Slicer Knives				
483482	W5626-7½	7½" Blade w/Serrated Edge	6 x 1 ea	3.25 lb
483503	W5627-10E	10" Blade w/Wavy Edge	6 x 1 ea	4.60 lb
483474	W5627-12GE	12" Blade w/Granton Edge	6 x 1 ea	3.25 lb
483484	W5627-12E	12" Blade w/Wavy Edge	6 x 1 ea	5.00 lb
Sandwich Knives				
483477	W5620-7E	7" Blade, Offset w/Serrated Edge	6 x 1 ea	1.80 lb
483476	W5610-8E	8" Blade, Wide w/Wavy Edge	6 x 1 ea	2.00 lb
483499	W5620-9E	9" Blade, Offset w/Wavy Edge	6 x 1 ea	3.50 lb
483478	W5610-10E	10" Blade, Wide w/Wavy Edge	6 x 1 ea	2.25 lb
Fillet Knives				
483471	W5614-8	8" Blade, Stiff, Narrow	6 x 1 ea	1.80 lb
483479	W5613-8	8" Blade, Flexible, Narrow	6 x 1 ea	1.80 lb
Bread Knife				
483497	W5621-10	10" Blade, Curved w/Micro Serr. Edge	6 x 1 ea	3.75 lb
Cimeter Knife				
483480	W5617-10	10" Blade	6 x 1 ea	3.38 lb
Cook's Knives				
483501	W5610-8	8" Blade, 2½" Wide	6 x 1 ea	3.50 lb
483502	W5610-10	10" Blade, 2½" Wide	6 x 1 ea	4.25 lb
483493	W5610-12	12" Blade, 2½" Wide	6 x 1 ea	5.00 lb
Santoku Knives				
483485	W5604-7GE	7" Blade w/Granton Edge	6 x 1 ea	3.30 lb
Utility Knives				
483494	W5622-6E	6" Blade w/Wavy Edge	6 x 1 ea	2.00 lb
Boning Knives				
483490	W5607-6	6" Blade, Curved, Semi-Stiff	6 x 1 ea	2.00 lb
483492	W5614-6	6" Blade, Narrow, Stiff	6 x 1 ea	2.00 lb
483496	W5615-6¼	6¼" Blade, Extra-Wide, Stiff	6 x 1 ea	1.10 lb
Paring Knives				
483495	W0547-4E	4" Blade, Spear Point w/Serrated Edge	24 x 1 ea	1.00 lb
483504	W0547-4	4" blade, Spear Point	24 x 1 ea	1.00 lb
483505	W5601-3¼	3¼" Blade, Chef's Style	24 x 1 ea	1.00 lb
Cleaver				
483506	W5680-6½	6½" Blade	6 x 1 ea	5.50 lb



KITCHEN

5600 SERIES PROFESSIONAL UTENSILS



- Well balanced and durable
- Non-slip ergonomic polypropylene handles w/Sanitized® Antimicrobial Protection
- High carbon stainless steel blades
- White handles

Item #	Mfg. #	Description	Cs Pk	Cs Wt
Turners				
483519	W5689	2½" x 2½" Blade, Mini	12 x 1 ea	1.00 lb
483514	W5686	4" x 3" Blade, Hamburger	6 x 1 ea	2.95 lb
483518	W5687	5" x 4" Blade, Steak & Hamburger	6 x 1 ea	1.90 lb
483524	W5685	6" x 3" Blade, Square End	6 x 1 ea	4.00 lb
483520	W5681	8" x 3" Blade, Perforated	6 x 1 ea	2.63 lb
483527	W5683	8" x 3" Blade	6 x 1 ea	2.70 lb
Kitchen Shears				
483513†	W656	3" x 5" Blade, Take-A-Part	6 x 1 ea	2.00 lb
Pizza Cutter				
483525†	W5691-4	4" dia Wheel	6 x 1 ea	2.50 lb
Dough Cutter/Scraper				
483528	W5697	6" x 3"	6 x 1 ea	3.25 lb
Pot Fork				
483516	W5654-12	12"	6 x 1 ea	1.65 lb
Pie & Cake Servers				
483517	W5694	2¼" x 4½" Blade, Pie	6 x 1 ea	2.88 lb
483511	W5695	3" x 5" Blade, Cake & Pie	6 x 1 ea	2.90 lb
Spatula				
483523	W5650-6	6" Blade, Baker's Icing	6 x 1 ea	1.80 lb
Spreaders				
483526	W5688-3½	3½" Blade, w/Straight Edge	6 x 1 ea	1.25 lb
483529	W5688E-3½	3½" Blade, w/Wavy Edge	6 x 1 ea	1.25 lb
Griddle Scrapers				
483509	W5692-3	3" Blade	6 x 1 ea	2.00 lb
483510	W5692-4	4" Blade	6 x 1 ea	2.30 lb

Sold in case pack or eaches.
† Not NSF ‡Not Sanitized®



KITCHEN

5100 SERIES BLACK FULLY FORGED CUTLERY



- High-carbon stainless steel blades • Durable Polyacetal™ handles
- Ergonomically designed, black three riveted handle provides a comfortable feel



Item #	Mfg. #	Description	Cs Pk	Cs Wt
Utility Knife				
483531	5111-6	6" Blade	6 x 1 ea	2.25 lb
Fillet Knife				
483532	5112-7	7" Blade, Flexible	6 x 1 ea	2.35 lb
Santoku Knife				
483533	5109-7GE	7" Blade, w/Granton Edge	6 x 1 ea	2.80 lb
Bread Knife				
483534	5121-8E	8" Blade, w/Serrated Edge	6 x 1 ea	2.56 lb
Chef's Knives				
483535	5110-8	8" Blade	6 x 1 ea	3.38 lb
483536	5110-10	10" Blade	6 x 1 ea	3.68 lb
Fork				
483539	5158	Cook's, Curved	6 x 1 ea	3.00 lb
Sharpening Steels†				
483522	3311-12	12" Diamond, Surface, Black Handle	6 x 1 ea	4.50 lb
483515	3303-12	12" Round Regular Cut, Black Handle	6 x 1 ea	4.65 lb

Sold in case pack or eaches.
† NSF and Sanitized®

WOOD HANDLE TURNERS

- Cs Pk 6 x 1 ea



Item #	Mfg. #	Description	Cs Wt
483507	4688M	6" x 5" Hamburger Turner	3.63 lb
483508	4689M	8" x 4" Steak Turner	3.25 lb

Sold in case pack or eaches.



SANI-SAFE® CUTLERY



- High quality stain-free steel with super sharp edges are hand-ground and honed
- High-impact, "Grip-Tex" handles are made of polypropylene, textured and formed for slip-resistant grip, safety and tough use
- An impervious seal of blade and handle provides utmost sanitary qualifications and pull out resistance
- Withstands high and low temperature
- Easily cleaned

Item #	Mfg. #	Description	Cs Pk	Cs Wt
Paring Knives				
393400	S107PCP	3¼" Blade, Clip Point	12 x 1 ea	1.00 lb
393402	S104PCP	3¼" Blade	12 x 1 ea	1.00 lb
437767	S104SC-PCP	3¼" Blade, Scalloped	12 x 1 ea	1.00 lb
397935	S104-3CARD	3¼" Blade	8 x 3 ea	2.25 lb
Sandwich Spreaders				
393411	S173SC-PCP	3½" Blade, Scalloped	12 x 1 ea	1.00 lb
393410	S173PCP	3½" Blade	12 x 1 ea	1.00 lb
Clam & Oyster Knives				
393388	S127PCP	Clam Knife, 3" Blade	12 x 1 ea	1.00 lb
394299	S137PCP	Galveston Oyster Knife, 4" Blade	6 x 1 ea	1.13 lb
394297	S121PCP	New Haven Oyster Knife, 2¾" Blade	6 x 1 ea	1.00 lb
Poultry Knife				
393407	S154HG-PCP	4½" Blade	6 x 1 ea	0.75 lb
Utility Knives				
393337	S156SC-PCP	6" Blade, Scalloped	6 x 1 ea	1.00 lb
393416	S158SC-PCP	8" Blade, Scalloped	6 x 1 ea	1.13 lb
393415	S142-9SC-PCP	9" Blade, Scalloped	6 x 1 ea	2.25 lb

Sold in case pack or eaches. PCP denotes individually packaged.



KITCHEN

V-LO® PROFESSIONAL CUTLERY

- Patented, state-of-the-art handle shape
- Distinctive Dex-Tex™ Armadillo texture
- Stain-free, high-carbon steel blades for edge retention and easy cleaning
- Soft comfort with solid handle control
- Protective finger guard
- Ultimate, long lasting sharp edges
- Superior blade shape for easier slicing
- Unique edge geometry for long-lasting, easily restored performance
- Hand honed to ultimate edge
- Cs Pk 6 x 1 ea



Item #	Mfg. #	Description	Cs Wt	Cs Wt
Paring Knife				
482592	V105PCP	3½" Blade	12 x 1 ea	1.50 lb
Boning Knife				
449479	V136N-PCP	6" Blade, Narrow	6 x 1 ea	1.88 lb
Sandwich Knife				
449486	V163-9SC-PCP	9" Blade, Offset Scalloped	6 x 1 ea	2.38 lb
Bread Knife				
449485	V162-8SC-PCP	8" Blade, Scalloped	6 x 1 ea	2.25 lb
Utility Knives				
482591	V156SC-PCP	6" Blade, Scalloped	6 x 1 ea	1.25 lb
481803	V158SC-PCP	8" Blade, Scalloped	6 x 1 ea	1.38 lb
Santoku Chef's Knife				
449487	V144-9GE-PCP	9" Blade, Duo-edge	6 x 1 ea	3.13 lb
Cook's Knife				
449484	V145-10PCP	10" Blade	6 x 1 ea	3.75 lb



CUTLERY CARE

Hand wash cutlery with mild detergent that is non caustic, then towel dry. Washing cutlery by placing in an automatic dishwasher is NOT suggested. This process allows metals to rub and dull the blade. Chemicals may stain and pit the blade. Wood handles eventually fade in color and start to split. Avoid soaking cutlery. Avoid using bleach or chlorinated chemicals. This tends to pit stain-free and high-carbon steel. Avoid soaking cutlery in stainless steel sinks, pots and pans or aluminum pots and pans. This may allow for the transfer of electrons (galvanic action) from one metal to another, causing pitting. Remove cutlery from condiments when kept in aluminum or stainless steel pans.

BUTCHER'S STEELS & SHARPENER



Item #	Mfg. #	Description	Cs	Pk	Cs Wt
394305	3-Way	Knife Sharpener, (3)12" Ceramic Rods	1	1 ea	4.50 lb
393329	DDS-12	Diamond Butcher's Steel, 12", Sani-Safe® Handle	6	1 ea	2.13 lb
394291	A12R	Butcher's Steel, 12", Hardwood Handle	6	1 ea	7.00 lb
394293	12SXL	Butcher's Steel, 12", Polypropylene Handle	6	1 ea	5.38 lb

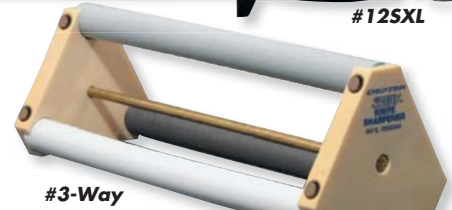

SANI-SAFE® CUTLERY

- Quality, stain-free, high-carbon steel
- High-impact "Grip-Tex" sanitary handles



Item #	Mfg. #	Description	Cs	Pk	Cs Wt
Boning Knives					
393374	S131-6PCP	6" Blade, Curved	6	1 ea	1.63 lb
393375	S136PCP	6" Blade, Wide	6	1 ea	1.75 lb
393378	S136N-PCP	6" Blade, Narrow	6	1 ea	1.63 lb
Fillet Knife					
393393	S133-8PCP	8" Flexible Blade, Narrow	6	1 ea	1.63 lb
Bread Knives					
393382	S162-8SC-PCP	8" Blade, Scalloped	6	1 ea	1.88 lb
393395	S163-9SC-PCP	9" Blade, Scalloped, Offset	6	1 ea	1.63 lb
393383	S147-10SC-PCP	10" Blade, Scalloped	6	1 ea	1.75 lb
Produce Knife					
458552	S185	5" Blade, Metal Finger Guard	12	1 ea	2.00 lb
393409	S186PCP	6" Blade, Metal Finger Guard	6	1 ea	1.25 lb
Cook's Knives					
393390	S145-8PCP	8" Blade	6	1 ea	2.38 lb
393389	S145-10PCP	10" Blade	6	1 ea	3.00 lb
397924	S145-12PCP	12" Blade	6	1 ea	3.63 lb
397921	S145-10SC-PCP	10" Blade, Scalloped	6	1 ea	3.00 lb
Butcher & Cimeter Knives					
393385	S112-10PCP	10" Blade, Butcher	6	1 ea	3.50 lb
393387	S132-10PCP	10" Blade, Cimeter	6	1 ea	3.38 lb
Roast Slicer					
393413	S140-12SC-PCP	12" Blade, Scalloped	6	1 ea	2.50 lb
437636	S140-12PCP	12" Blade	6	1 ea	2.38 lb
Cheese Knife					
393386	S118-14DH	14" Blade, Double Handled	2	1 ea	2.66 lb
Knife Sets					
431475	S173SC-3-RYG	3 Scalloped Spreaders, Colored Handles	8	1 set	2.50 lb
429560	S163-7SC/9SC	2 Bread Knives, Offset, White Handles	6	1 set	3.25 lb

Sold in case pack or eaches. PCP denotes individually packaged.



#S131-6PCP



#S136PCP



#S136N-PCP



#S133-8PCP



#S162-8SC-PCP



#S173SC-3-RYG



#S140-12PCP



#S145-10PCP



#S163-9SC-PCP



#S145-12PCP



#S147-10SC-PCP



#S112-10PCP



#S185



#S132-10PCP



#S186PCP



#S140-12SC-PCP



#S145-8PCP

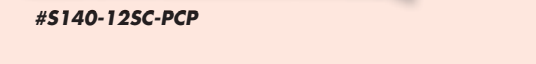

#S118-14DH



#S145-10SC-PCP



#S163-7SC/9SC



KITCHEN



#S174PCP



#S175



#S284 6 1/2PCP



#S196PCP



#S171PCP



#S172PCP



#S172 1/2PCP



#S182-1/2



#S285-3PCP



#S286-4PCP



#S285-4PCP



#S286-6

SANI-SAFE® CUTLERY

- Quality, stain-free, high-carbon steel
- High-impact "Grip-Tex" sanitary handles



Item #	Mfg. #	Description	Cs Pk	Cs Wt
Bakery				
437683	S174PCP	Pie Server/Knife, 4½" Blade	6 x 1 ea	1.00 lb
437542	S175	Pie Server, 5" Blade	12 x 1 ea	3.00 lb
437849	S284 6 1/2PCP	Baker's Spatula, 6½" Blade	6 x 1 ea	1.00 lb
437813	S196PCP	Dough Cutter, 6" x 3"	6 x 1 ea	2.38 lb
Turners				
437899	S171PCP	Mini, 2½" x 2¼" Blade	6 x 1 ea	0.75 lb
435463	S172PCP	Pancake, 4" x 2" Blade	6 x 1 ea	1.13 lb
437905	S172 1/2PCP	Pancake, 4" x 2½" Blade	6 x 1 ea	1.25 lb
393348	S182-1/2PCP	Slotted, 4" x 2½" Blade	6 x 1 ea	1.25 lb
437912	S285-3PCP	Hamburger, 4" x 3" Blade	6 x 1 ea	3.25 lb
396040	S286-4PCP	Hamburger, 4" x 3" Blade	6 x 1 ea	2.00 lb
393350	S285-4PCP	Hamburger, 5" x 4" Blade	6 x 1 ea	3.88 lb
437891	S286-6	Hamburger, 6" x 3" Blade	6 x 1 ea	2.52 lb
394302	S286-6PCP	Hamburger, 6" x 3" Blade	6 x 1 ea	2.52 lb
435468	S286-6RC	Cake, Rounded Corner, 6" x 3" Blade	6 x 1 ea	2.63 lb
437894	S286-8PCP	Cake, 8" x 3" Blade	6 x 1 ea	2.63 lb
393363	PS286-8	Perforated, 8" x 3" Blade	6 x 1 ea	2.88 lb
437886	PS286-8PCP	Perforated, 8" x 3" Blade	6 x 1 ea	2.88 lb
Cook's Fork				
393394	S205PCP	13" length	6 x 1 ea	1.63 lb
Griddle Scraper				
435462	S294PCP	4" Blade	6 x 1 ea	2.00 lb

Sold in case pack or eaches. PCP denotes individually packaged.



#S286-6RC



#S286-8PCP



#PS286-8PCP



#S205PCP



#S294PCP



SOFGRIP™ CUTLERY SET & CASE

- All knives feature stain-free, high-carbon steel blades with smooth or scalloped edges
- Set (#SGCC7) includes 3¼" paring knife, 6" narrow boner, 6" scalloped utility knife, 10" cook's knife, 12" duo-edge roast slicer, 9" scalloped offset slicer, 12" diamond sharpener and 7 pc cutlery case (CC1)
- Cs Pk 1 x 1 ea



Item #	Mfg. #	Description	Cs Wt
394303	SGCC7	7 pc Cutlery Set With Black Case	3.00 lb
393403	CC1	Cutlery Case Only, Black	1.00 lb

3-PIECE SANI-SAFE® CUTLERY SET

- Card contains a S104 3¼" paring knife, a S163-9SC 9" offset scalloped slicer and S145-10 10" cook's knife, all in one convenient set
- Blades feature stain-free, high-carbon steel, married to slip-resistant polypropylene handles



Item #423644

Mfg. #SS3
Cs Pk 6 x 3 ea
Cs Wt 5.50 lb

Sold in case pack or eaches.



SOFGRIP™ CUTLERY

- The ultimate in non-slip professional cutlery
- SofGrip™ – the first handle that literally molds to your hand and becomes its extension
- Ergonomically designed to help reduce stress
- The combination of this soft-feel, distinctive handle and the world's sharpest hand-ground, hand-honed knife edge provides the highest quality and finest line of professional cutlery to the foodservice market
- Available with white or black handles

Item #	Mfg. #	Description	Cs Pk	Cs Wt
Paring Knives				
397844	SG107PCP	3¼" Blade, Clip Point, White Hdl.	12 x 1 ea	1.25 lb
425197	SG104B-PCP	3¼" Blade, Black Hdl.	12 x 1 ea	1.25 lb
Boning Knives				
423649	SG136B-PCP	6" Wide Blade, Black Hdl.	6 x 1 ea	2.00 lb
423650	SG136FB-PCP	6" Flexible Blade, Black Hdl.	6 x 1 ea	1.88 lb
Fillet Knife				
437599	SG133-8PCP	8" Narrow Blade, White Hdl.	6 x 1 ea	2.00 lb
Sandwich Knives				
394304	SG163-9SC-PCP	9" Blade, Offset, Scalloped, White Hdl.	6 x 1 ea	2.00 lb
423633	SG163-9SCB-PCP	9" Blade, Offset, Scalloped, Black Hdl.	6 x 1 ea	2.00 lb
Bread Knives				
393396	SG162-8SC-PCP	8" Blade, Scalloped, White Hdl.	6 x 1 ea	2.25 lb
423659	SG162-8SCB-PCP	8" Blade, Scalloped, Black Hdl.	6 x 1 ea	2.25 lb
393384	SG147-10SC-PCP	10" Blade, Scalloped, White Hdl.	6 x 1 ea	2.25 lb
Utility Knives				
423657	SG156SCB-PCP	6" Blade, Scalloped, Black Hdl.	6 x 1 ea	1.75 lb
423632	SG158SCB-PCP	8" Blade, Scalloped, Black Hdl.	6 x 1 ea	1.88 lb
Santoku Chef's Knife				
432394	SG144-7B-PCP	7" Blade, Black Hdl.	6 x 1 ea	1.88 lb
Cook's Knives				
393391	SG145-10PCP	10" Blade, White Hdl.	6 x 1 ea	3.13 lb
423655	SG145-10B-PCP	10" Blade, Black Hdl.	6 x 1 ea	3.13 lb
Slicers				
393340	SG140-12PCP	12" Blade, White Hdl.	6 x 1 ea	2.75 lb
393342	SG140-12SC-PCP	12" Blade, Scalloped, White Hdl.	6 x 1 ea	2.75 lb
437846	SG140-12GE-PCP	12" Blade, Duo-edge, White Hdl.	6 x 1 ea	2.75 lb

Sold in case pack or eaches. PCP denotes individually packaged.



#SG107PCP



#SG104B-PCP



#SG136B-PCP



#SG136FB-PCP



#SG133-8PCP



#SG163-9SC-PCP



#SG163-9SCB-PCP



#SG162-8SC-PCP



#SG162-8SCB-PCP



#SG145-10PCP



#SG145-10B-PCP



#SG140-12PCP



#SG140-12SC-PCP



#SG140-12GE-PCP

KITCHEN



#SG147-10SC-PCP



#SG156SCB-PCP



#SG158SCB-PCP



#SG144-7B-PCP



CONNOISSEUR® CUTLERY

- The finest made professional cutlery for hotels, restaurants, and institutions
- Edges are stone-ground by hand and honed to ultimate sharpness
- Formed, sanitary handle of laminated rosewood is impervious to stain, hot water and food acids
- Secured with large brass compression rivets
- Stain-free, high carbon steel blade

Item #	Mfg. #	Description	Cs Pk	Cs Wt
Cook's Knife				
393303	45-10PCP	10" Blade	6 x 1 ea	3.63 lb
Slicer				
393302	40D-12PCP	12" Blade, Duo-edge	6 x 1 ea	3.38 lb

Sold in case pack or eaches. PCP denotes individually packaged.



#45-10PCP



#40D-12PCP



TRADITIONAL™ CUTLERY

- The choice of professionals for both quality and widest selection in the world
- The right knife for every cutting purpose
- All have the proper blade length, shape, flexibility, balance and handle design
- Edges are hand-ground and honed to extreme sharpness
- Blades are available in either special processed high-carbon or high-carbon, stain-free steel
- Formed or traditional shaped wooden handles are tightly secured to blade tang with compression rivets

Item #	Mfg. #	Description	Cs Pk	Cs Wt
Rosewood Handle				
393315	S197PCP	Paring Knife, 3" Blade, Clip Point	12 x 1 ea	0.75 lb
393321	S2493-1/2SC	Sandwich Spreader, 3½" Blade, Scalloped	12 x 1 ea	1.50 lb
393316	S42	Parisian Cutter, 7/8" x 1 1/8" Bowls	12 x 1 ea	1.50 lb
Hardwood Handle				
393308	S5198PCP	Chinese Chef's Knife, 8" x 3¼" Blade	6 x 1 ea	4.50 lb

Sold in case pack or eaches. PCP denotes individually packaged.



#S197PCP



#S2493-1/2SC



#S42



#S5198PCP



#S160-16



#S196PCP



#PR180-20

SANI-SAFE® & TRADITIONAL™ PIZZA TOOLS

Item #	Mfg. #	Description	Cs Pk	Cs Wt
Dough Cutters				
437813	S196PCP	Sani-Safe®, 6" x 3" Blade	6 x 1 ea	2.38 lb
Pizza Cutters				
393319	PR180-20	Sani-Safe® Rocker, 20"	6 x 1 ea	8.38 lb
393320	S3A	Dexter, 2¾" Blade, Alum. Handle	12 x 1 ea	4.50 lb
393364	P3A-PCP	Sani-Safe®, 2¾" Blade	6 x 1 ea	2.00 lb
437368	P177A-4PCP	Sani-Safe®, 4" Blade	6 x 1 ea	2.50 lb
437361	P17	Sani-Safe®, 4" Blade Only	6 x 1 ea	0.88 lb
Pizza Knives				
393397	S160-16	Sani-Safe®, 16" Blade,	6 x 1 ea	7.00 lb
393401	S160-18	Sani-Safe®, 18" Blade,	6 x 1 ea	7.63 lb
393405	S161	Dexter Guard Attachment	6 x 1 ea	1.75 lb
Pizza Servers				
393406	S176	Sani-Safe®, 6" x 5" Blade,	6 x 1 ea	2.88 lb
437683	S174PCP	Sani-Safe®, 4½" x 2¼" Blade,	6 x 1 ea	1.00 lb
435453	S244PCP	Dexter, 4½" Blade	6 x 1 ea	1.25 lb

Sold in case pack or eaches. PCP denotes individually packaged.



#P177A-4PCP



#S3A



#P3A-PCP



#S161



#S174PCP



#S176



#S244PCP

KITCHEN

TRADITIONAL™ BAKERY

- Rosewood handles
- Brass rivets



#S496



#S2496PCP



#S2498



#S24910B



#S2496-1/2

Item #	Mfg. #	Description	Cs Pk	Cs Wt
393312	S496	Dough Cutter, 6" x 3" Blade	6 x 1 ea	2.50 lb
435454	S2496PCP	Baker's Spatula, 6" x 1 1/16", Flexible	6 x 1 ea	0.75 lb
393326	S2498	Baker's Spatula, 8" x 1 1/4" Blade, Flexible	6 x 1 ea	1.25 lb
393325	S24910B	Baker's Spatula, 10" x 1 1/8" Blade, Offset	6 x 1 ea	2.25 lb
394301	S2496-1/2	Frosting Spatula, 6 1/2" x 1 1/2" Blade	12 x 1 ea	2.00 lb

Sold in case pack or eaches. PCP denotes individually packaged.

TRADITIONAL™ SERVERS, TURNERS & FORKS



#S240PCP



#S242PCP



#S244PCP



#S245R-PCP



#85849PCP



#S8696PCP



#S8699PCP



#S8694



#85859PCP



#S8698PCP



#PS8698PCP



#LS8698



#S2493 1/2PCP



#L4504



#28912MF-PCP



#S2896 1/2PCP

Item #	Mfg. #	Description	Cs Pk	Cs Wt
Turners - With Rosewood Handles				
435457	S240PCP	Mini, 2" x 2½" Blade	6 x 1 ea	0.75 lb
435458	S242PCP	Cake/Pancake Server, 4" x 2" Blade	6 x 1 ea	1.13 lb
393335	S242 1/2PCP	Cake/Pancake Server, 4" x 2½" Blade	6 x 1 ea	1.25 lb
435453	S244PCP	Pie Knife, 4½" x 2¼" Blade, Offset	6 x 1 ea	1.25 lb
393317	S245R-PCP	Pie Knife, 5" Blade, Offset	6 x 1 ea	1.50 lb
397937	85849PCP	Hamburger, 4" x 3" Blade	6 x 1 ea	3.25 lb
393336	S8696PCP	Hamburger, 6" x 3" Blade	6 x 1 ea	3.00 lb
393339	S8699PCP	Steak, 8" x 4" Blade	6 x 1 ea	5.63 lb
437898	S8694	Hamburger, 4" x 3" Blade	6 x 1 ea	2.50 lb
393372	85859PCP	Hamburger, 5" x 4" Blade	6 x 1 ea	3.75 lb
437897	85869	Hamburger, 6" x 5" Blade	6 x 1 ea	5.75 lb
393338	S8698PCP	Grill, 8" x 3" Blade	6 x 1 ea	3.13 lb
393370	PS8698PCP	Perforated, 8" x 3" Blade	6 x 1 ea	3.25 lb
393332	LS8698	Long handle, 8" x 3" Blade, 20" OA	6 x 1 ea	4.75 lb
Hamburger Trowel - With Hardwood Handle				
393331	1515	Hamburger, 4" x 5" Blade	6 x 1 ea	4.25 lb
Sandwich Spreaders - With Rosewood Handle				
397923	S2493 1/2PCP	3½" length	12 x 1 ea	1.50 lb
Griddle Scraper - With Walnut Handle				
393371	L4504	3" Blade, Walnut Handle	6 x 1 ea	2.00 lb
Cook's Forks - With Rosewood Handles				
393314	28912MF-PCP	Forged, 7" Fork, 12" OA	6 x 1 ea	2.50 lb
393313	S2896 1/2PCP	6½" Fork, 13½" OA	6 x 1 ea	2.00 lb

Sold in case pack or eaches. PCP denotes individually packaged.



BASIC KNIVES & THEIR USES

Paring Knife

Four styles of paring knives are most common...curved, spear, sharp and clip point. Curved or Sharp paring knives may be used for finely sliced pepper rings, slivered olives and cherries. A cook's paring or speared point knife can be used to remove corn from the cob, break up heads of lettuce or cabbage, peel fruit and vegetables, cut beans, etc. A clip point knife is used for eyeing potatoes, seeding, peeling and pitting.

Utility Knife

Sharp 6" utility knife is most efficient for slicing non solid fruits and vegetables, such as tomatoes or squash. For acid fruits a stainless steel blade is preferred. Useful for cutting melon rings, heads of lettuce into wedges or preparing cabbage.

Boning Knife

Blades vary in length from 4" to 8". Cooks simplify carving and get extra servings by boning out a roast when it is partially cooked. For boning roasts, whole hams, lamb legs, veal legs and filleting fish, a narrow blade is the best.

Butcher, Cimeter Steak Knife & Cleaver

For odd jobs in the kitchen, butcher and cimeter steak knives can be used for dicing salt pork, cubing cold meats, cutting steaks or trimming raw meat. The cleaver is used for opening lobsters, cutting poultry, etc.

Cook's Knife

Blade lengths of 8" to 12". Cook's knife has more uses than any other knife in a kitchen. Blade is wider at the handle and tapers to the point. Deep choil protects knuckles when dicing or mincing celery, onions, nuts, meats, parsley, peppers, etc.

Slicers & Carvers

Most important knife in this category is the roast beef slicer. It is used to carve rounds, boneless roasts, boiled briskets, pot roasts and standing rib roasts. The roast beef slicer has a wider blade and tends to have a more stiff, straight edge than serrated edge blades.

KITCHEN

DEXTER BASICS® CUTLERY



- Designed for those who want quality at a lower price point
- The breadth of the line covers every commercial cutting or serving purpose
- Blades are from 400 series stain-free, high-carbon steel and are hollow ground for easy edge maintenance and rapid resharpening
- Servers, turners and scrapers of stainless steel are ground with precision for the right flexibility and stiffness
- Handles are of high impact polypropylene and slip-resistant
- Easily cleaned



#P40843



#P40003



#P94843



#P94816



#P94846



#P94005



#P94807



#P94803



#P94801



#P94802



#P94831



#P94804



#P94805



#P94852

Item #	Mfg. #	Description	Cs Pk	Cs Wt
Paring Knives				
393359	P40843*	3¼" Blade	24 x 1 ea	1.50 lb
393357	P40003*	2¾" Blade, Clip Point	48 x 1 ea	3.00 lb
393356	P94843	3½" Blade, Tapered Point	12 x 1 ea	1.00 lb
397872	P94816	3" Blade, Clip Point	12 x 1 ea	1.00 lb
397880	P94846	3½" Blade, Scalloped Edge	12 x 1 ea	1.00 lb
437634	P94005	5¼" Fruit Knife, Scalloped Edge	12 x 1 ea	1.00 lb
Bread Knives				
397869	P94807	8" Blade, Offset, Scalloped	6 x 1 ea	1.88 lb
393351	P94803	8" Blade, Scalloped	6 x 1 ea	1.75 lb
Boning Knives				
393349	P94823	6" Curved Blade, Stiff	6 x 1 ea	1.63 lb
Cook's Knives				
397864	P94801	8" Blade	6 x 1 ea	2.50 lb
393352	P94802	10" Blade	6 x 1 ea	3.13 lb
393353	P94831	10" Blade, Wide	6 x 1 ea	3.50 lb
Slicers				
393365	P94804	10" Blade, Scalloped	6 x 1 ea	2.25 lb
393366	P94805	12" Blade, Scalloped	6 x 1 ea	2.50 lb
Turners, Scrapers & Servers				
393360	P94852	Pie Server, 4½" x 2¼" Blade	12 x 1 ea	2.00 lb
393361	P94853	Pie Server, 5" Blade	12 x 1 ea	3.00 lb
397913	P94851	Pancake Turner, 4" x 2¼" Blade	12 x 1 ea	2.50 lb
397914	P94854	Hamburger Turner, 4" x 3" Blade	6 x 1 ea	2.50 lb
393367	P94855	Hamburger Turner, 6" x 3" Blade	6 x 1 ea	3.25 lb
393369	P94856	Cake Turner, 8" x 3" Blade	6 x 1 ea	2.63 lb
393354	P94850	Griddle Scraper, 4" Blade	12 x 1 ea	4.00 lb
Pizza Cutter				
447745	P94ZZA-4*	4" Blade	12 x 1 ea	4.25 lb

Sold in case pack or eaches. *Not NSF Certified



#P94ZZA-4



#P94853



#P94855



#P94851



#P94856



#P94852



#P94850

MOTHER RUSSELL® SPREADERS



- Stainless steel with polypropylene handle

Item #	Mfg. #	Description	Cs Pk	Cs Wt
397922	S170	3½" length	12 x 1 ea	1.00 lb
423639	S170L-3	4½" length, 3 Pack	12 x 3 ea	3.50 lb

Sold in case pack or eaches.



#S170



#S170L-3

13-PIECE GOURMET SET

- Rosewood handles
- 13-piece set includes: washable canvas knife roll, 14" sharpening steel, 8" spatula, 3/4" parer, melon baller, 6" wide, stiff, boning knife, 10" chef's, 7" chef's, 12" slicer, 12" pot fork, corkscrew, peeler, 10" french whip



Item #379938
Mfg. #46050
Cs Pk 1 x 1 set
Cs Wt 5.10 lb



GARNISHING KIT

- 7-piece set includes: canvas roll, vegetable peeler, decorating knife, fruit decorator, channel knife, melon baller and lemon zester
- Black nylon handles



Item #379939
Mfg. #46550
Cs Pk 1 x 1 kit
Cs Wt 0.60 lb



CUTLERY WITH ROSEWOOD HANDLES

- Features Victorinox® hand finished, high carbon, stainless steel blades with classic rosewood handles
- Ergonomically designed to minimize wrist tension





Item # Mfg. # Description

Paring Knives

- | | | | | | | |
|---------------|--------|--------------------------|-----------|---------|---------------|--|
| 379750 | 40001 | 3/4" Blade | 12 x 1 ea | 0.40 lb | #40001 |  |
| 379766 | 40007* | 2 1/2" Bird's Beak blade | 12 x 1 ea | 0.70 lb | #40007 |  |
- * Light wood handle





Utility Knives

- | | | | | | | |
|---------------|-------|------------------------|----------|---------|---------------|--|
| 379755 | 40002 | 4 3/4" Blade | 6 x 1 ea | 0.70 lb | #40002 |  |
| 379760 | 40003 | 4 3/4" Wavy Edge Blade | 6 x 1 ea | 0.70 lb | #40003 |  |

Boning Knife

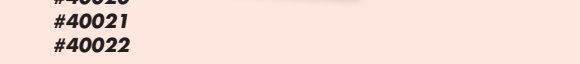
- | | | | | | | |
|---------------|-------|------------------------|----------|---------|---------------|--|
| 379772 | 40013 | 6" Stiff, Narrow Blade | 6 x 1 ea | 1.40 lb | #40013 |  |
|---------------|-------|------------------------|----------|---------|---------------|--|

Chef's Knives

- | | | | | | | |
|---------------|-------|--|----------|---------|---------------|---|
| 379785 | 40020 | 8" Blade, 2" wide at Handle | 6 x 1 ea | 2.80 lb | #40020 |  |
| 379788 | 40021 | 10" Blade, 2 1/4" wide at Handle | 6 x 1 ea | 3.00 lb | #40021 |  |
| 379802 | 40022 | 12" Blade, 2 3/8" wide at Handle | 6 x 1 ea | 3.90 lb | #40022 |  |
| 379812 | 40027 | 7 1/2" Wavy, Stiff Edge, 1 1/2" wide at Handle | 6 x 1 ea | 1.50 lb | #40027 |  |
| 379807 | 40023 | 10" Sandwich Knife, Wavy/Straight Edge | 6 x 1 ea | 3.10 lb | #40023 |  |

Bread Knife

- | | | | | | | |
|---------------|-------|--|----------|---------|---------------|--|
| 379820 | 40040 | 10 1/4" Wavy Edge Blade, 1 1/4" wide at Handle | 6 x 1 ea | 2.10 lb | #40040 |  |
|---------------|-------|--|----------|---------|---------------|--|

Carving Fork

- | | | | | | | |
|---------------|-------|---|----------|---------|---------------|--|
| 379846 | 40199 | 4 1/2" Stainless Steel Tines, 10" Overall | 6 x 1 ea | 1.50 lb | #40199 |  |
|---------------|-------|---|----------|---------|---------------|--|

Butcher Steel

- | | | | | | | |
|---------------|-------|------------------------|----------|---------|---------------|--|
| 379832 | 40084 | 12" Regular Cut, Round | 6 x 1 ea | 6.90 lb | #40084 |  |
|---------------|-------|------------------------|----------|---------|---------------|--|

Sold in case pack or eaches.

KITCHEN

FORGED CUTLERY

- Features fully forged, high carbon, stainless steel blades
- Black Pom handle
- Cs Pk 1 x 1 ea

Item #	Mfg. #	Description	Cs	Wt
Paring Knife				
431534	47603	3½" Blade	0.13	lb
Chef's Knives				
431535	47620	8" Blade	0.62	lb
431537	47621	10" Blade	0.75	lb
Santoku Knife				
431541	47525	7" Blade, Granton Edge	0.97	lb



MOLDED HANDLE CUTLERY

- Features Victorinox® hand finished, high carbon, stainless steel blades with nylon or Fibrox® handles
- Fibrox® handles are NSF approved, dishwasher safe and slip resistant

Item #	Mfg. #	Description	Cs	Pk	Cs	Wt
Paring Knives						
Black nylon handles, small						
379930	40600	3¼" Blade	12	x 1 ea	0.70	lb
379932	40602	3¼" Blade, Wavy Edge	12	x 1 ea	0.70	lb
Utility Knife						
Black nylon handle, large						
379872	40501	4" Blade	12	x 1 ea	1.00	lb
Boning Knife						
Black Fibrox® handle						
379879	40511	6" Stiff, Narrow Blade	6	x 1 ea	1.70	lb
Chef's Knives						
Black Fibrox® handles						
431542	47552	5" Blade, 1¼" wide at Handle	1	x 1 ea	0.21	lb
379891	40520	8" Blade, 2" wide at Handle	6	x 1 ea	2.90	lb
379896	40521	10" Blade, 2½" wide at Handle	6	x 1 ea	3.20	lb
Bread Knives						
Black Fibrox® handles, wavy edge blade						
379899	40547	10¼" Blade, 1½" wide at Handle	6	x 1 ea	2.50	lb
379903	40548	7" Blade, Slant Tip	6	x 1 ea	1.30	lb
379920	40549	8" Blade, Slant Tip	6	x 1 ea	1.80	lb
Slicers						
Black Fibrox® handles						
379934	40640	10" Blade, Wavy Edge, 1½" wide at Handle	6	x 1 ea	2.10	lb
379937	40645	12" Blade, Granton Edge, 1½" wide at Handle	6	x 1 ea	3.10	lb
400091	40646	14" Blade, Granton Edge, 1½" wide at Handle	6	x 1 ea	2.70	lb
Butcher Steels						
Black plastic handles						
379923	40584	12" Regular Cut, Round	6	x 1 ea	10.30	lb
379926	40586	14" Regular Cut, Round	6	x 1 ea	11.60	lb



KITCHEN

HEAVY DUTY CLEAVER

- Wood handle, 4.0 mm
- 3½" x 8" stainless steel blade



Item #507484
Mfg. #KC-301
Cs Pk 24 x 1 ea
Cs Wt 1.10 lb



Sold in case pack or eaches.



NEMCO
FOOD EQUIPMENT
"Exceeding your expectations"

NSF

EASY TOMATO SLICER™

- Compact, sturdy and easy to use
- Cleanly cut mounds of uniformly sliced tomatoes in seconds
- Features a unique design for fast, trouble-free operation
- Razor sharp, stainless steel blades assure fast, even cuts
- Vertical handle and protective guards improve user comfort and safety

Item #	Mfg. #	Description	Cs Wt
423073	55600-1	3/8" Cut Size	9.00 lb
423074	55600-2	1/4" Cut Size	9.00 lb
423270	466-1	3/8" Blade Assembly	0.60 lb
423271	466-2	1/4" Blade Assembly	0.60 lb



NSF

EASY TOMATO SLICER II™

- Handles large tomatoes
- Pretensioned cartridge blade assembly for trouble-free performance
- Compact, efficient, fast and simple to use
- Safe and convenient
- Ergonomic handle
- 3/8" cut size

Item #476272
Mfg. #56600-1
Cs Pk 1 x 1 ea
Cs Wt 11.00 lb

NEMCO
FOOD EQUIPMENT
"Exceeding your expectations"

REDCO® TOMATO PRO™

- Prepare perfect tomato slices fast
- Ideal for slicing tomatoes, strawberries or mushrooms in high volume operations
- "Positive stop" arm helps keep slicer sturdy
- 1/4" cut size

Complete Unit
Item #370878
Mfg. #0644N
Cs Pk 1 x 1 ea
Cs Wt 14.22 lb

NSF

VOLLRATH®
Setting the Standard™

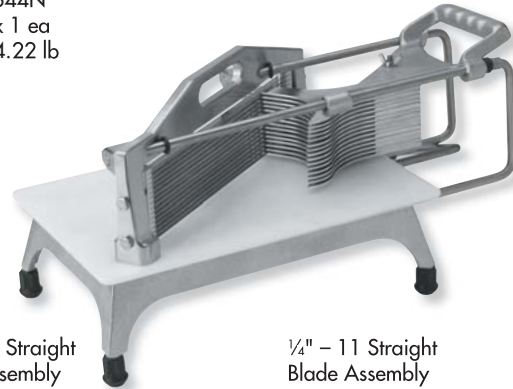

3/16" - 15 Straight
Blade Assembly
Item #377282
Mfg. #0653
Cs Pk 1 x 1 ea
Cs Wt 0.54 lb

1/4" - 11 Straight
Blade Assembly
Item #370630
Mfg. #0654
Cs Pk 1 x 1 ea
Cs Wt 0.48 lb

REDCO® INSTASLICE™

- Pop-in pop-out blade assembly
- Thermoset blade frames never need adjustment and will not corrode
- Corrosion-resistant polyurethane food carrier
- Hardcoat® pusher head fingers resist corrosion
- Detachable table stop assures processor will stay in place
- Scalloped blades
- 3/16" cut with safety guard

Item #398949
Mfg. #15105
Cs Pk 1 x 1 ea
Cs Wt 18.50 lb

VOLLRATH®
Setting the Standard™

NSF

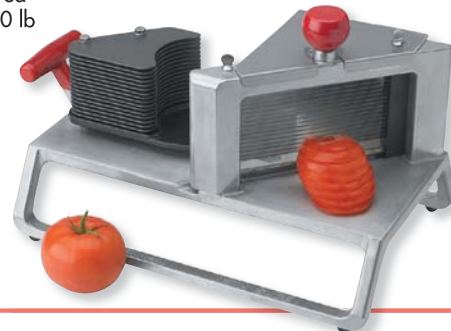

REDCO® TATER KING™ SCOOPER

- Scoop, skin and wedge four partially baked potatoes in less than a minute
- Quickly prepare deep fried skins, steak fries, twice baked potatoes and more

Item #397855
Mfg. #1801
Cs Pk 12 x 1 ea
Cs Wt 5.58 lb

Sold in case pack or eaches.



VOLLRATH®
Setting the Standard™

REDCO® TOMATO KING™ SCOOPER

- The stainless steel teeth work faster than any knife
- One quick twist removes the tomato core
- Use to core strawberries, score cucumbers and make mini melon balls, too
- 2 scoopers per card

Item #379589
Mfg. #1401
Cs Pk 24 x 1 set
Cs Wt 2.64 lb

Sold in case pack or carded set.



REDCO® INSTACUT™ 3.5 MANUAL FOOD PROCESSING SYSTEM

- Produces perfectly cut vegetables and fruits at least 3 times faster than cutting by hand
- One-stroke operation produces quick, clean cuts, without the bruising and waste of other methods
- Simple, one-piece blade assembly – pops in, pops out – change from dice to wedge in seconds
- Quick, easy cleanup • Aluminum base with stainless steel rods • Easy-grip handle

Item #	Mfg. #	Description	Cs Pk	Cs Wt
397830	15000	1/4" Dice, Complete Unit	1 x 1 ea	7.70 lb
396960	15062	1/4" Dice, Blade Assembly Only	1 x 1 set	0.54 lb
378470	15006	8 Section Wedger, Complete unit	1 x 1 ea	8.00 lb
416076	15063	3/8" Dice, Blade Assembly Only	1 x 1 set	0.44 lb
386170	15002	1/2" Dice, Complete Unit	1 x 1 ea	7.50 lb
386460	15064	1/2" Dice, Blade Assembly Only	1 x 1 set	1.00 lb
396959	379008	1/4" and 1/2" Pusher Block Head	1 x 1 ea	0.20 lb
432964	379009	3/8" Cut Replacement Pusher Block Head	1 x 1 ea	0.10 lb



Setting the Standard™



EASY WEDGER™

- Precision stainless steel blades stay sharp – cut cleanly with one easy stroke
- Cut perfect wedges every time
- Easy to clean
- Sturdy base



Item #	Mfg. #	Description	Cs Pk	Cs Wt
423071	55550-6	6-Section Wedge	1 x 1 ea	6.00 lb
423072	55550-8	8-Section Wedge	1 x 1 ea	6.00 lb
423269	428-8	8-Section Blade Assembly	1 x 1 set	0.60 lb

REDCO® WEDGEMASTER®

- Great for fast-production kitchen, buffet and bar preparation
- Cuts fruits consistently and predictably for constant high-quality food and drink presentations
- 6 or 8 section blade assembly removes for easy cleaning and replacement
- Cs Pk 1 x 1 ea



6 Section Wedge Complete Unit
Item #376679
 Mfg. #606N
 Cs Wt 5.38 lb

6 Section Wedge Blade Assembly
Item #378479
 Mfg. #306
 Cs Wt 0.22 lb

8 Section Wedge Blade Assembly
Item #412975
 Mfg. #308
 Cs Wt 0.24 lb



Setting the Standard™



EASY-SLICER™ VEGETABLE SLICER

- Unique, adjustable, stainless steel blade provides a full range of slicing options, from 1/16" to 1/2" in thickness
- Simply turn the thumbscrew control to lock in your setting on the easy-to-read calibrated gauge

Item #423064
 Mfg. #55200AN
 Cs Pk 1 x 1 ea
 Cs Wt 12.00 lb



REDCO® PETROL GEL

- Designed specifically for use with all Redco® manual food processors
- Tasteless and odorless
- Impervious to water

Item #429662
 Mfg. #15149
 Cs Pk 1 x 1 ea
 Cs Wt 0.42 lb



Setting the Standard™



REDCO® CUBEKING™

- Cut cheese cubes, sticks, square blocks and rectangular blocks, fast and uniform
- 3/4" cut

Item #397834
 Mfg. #1811
 Cs Pk 1 x 1 ea
 Cs Wt 4.10 lb



Setting the Standard™



EASY FRYKUTTER™

- Short throw handle reduces fatigue and increases production
- One smooth easy pull delivers plenty of pressure to cut potatoes and other vegetables
- Wall or countertop operation
- 20"l x 9"w x 10"h
- Cs Pk 1 x 1 ea

NSF



NEMCO
FOOD EQUIPMENT
"Exceeding your expectations"

Item #	Mfg. #	Description	Cs Wt
423066	55450-1	¼" Cut Size	12.00 lb
423068	55450-2	⅜" Cut Size	12.00 lb
Accessories			
459657	55727-8	8 Section Wedger Kit	4.00 lb
431514	55417	¼" & ½" Push Block	1.00 lb

SPIRAL FRY™ POTATO CUTTER

- Turn potatoes into platefuls of uniquely appetizing fresh, thin spiral fries
- Simply load a potato and turn the easy-action drive screw – no peeling required
- Easily releases and retracts for fast reloading
- Handles up to a 70-count potato

Item #423050
Mfg. #55050AN
Cs Pk 1 x 1 ea
Cs Wt 6.00 lb



NSF

NEMCO
FOOD EQUIPMENT
"Exceeding your expectations"

EASY CHOPPER™

- Comfortable, weighted handle does most of the work for you to cut cleanly in one stroke
- One cutting grid included
- Optional interchangeable cutting grids are sold separately
- Cs Pk 1 x 1 ea

NSF



NEMCO
FOOD EQUIPMENT
"Exceeding your expectations"

Item #	Mfg. #	Description	Cs Wt
423069	55500-1	¼" Cut Chopper	8.00 lb
423070	55500-2	⅜" Cut Chopper	8.00 lb
Accessories			
423265	436-1	¼" Blade Assembly	0.60 lb
423266	436-2	⅜" Blade Assembly	0.60 lb
459651	55424-2	⅜" Blade and Holder Assembly	2.00 lb
459657	55727-8	8 Section Wedger Kit	4.00 lb
431514	55417	¼" & ½" Push Block	1.00 lb

EASY CHOPPER II™

- Chop and slice the big veggies with less effort
- Comfortable, weighted handle does most of the work for you to cut cleanly in one stroke
- One super-sharp, stainless steel, interchangeable cutting grid included
- Cs Pk 1 x 1 ea

NSF



NEMCO
FOOD EQUIPMENT
"Exceeding your expectations"

Item #	Mfg. #	Description	Cs Wt
457670	56500-1	¼" Cut Chopper	11.00 lb
432435	56500-2	⅜" Cut Chopper	11.00 lb

FRENCH FRY POTATO CUTTER

- Clean and durable stainless steel "V" trough guarantees smooth operation
- Heavy, strong, nickel-plated ductile cast iron frame
- Handle with screw holes (screws not included) for permanent mounting to table or wall
- Optional wall bracket holds potato cutter securely on wall to save counter space
- Sure grip handle – won't slip even when wet
- 11½" long at base, 14" long with handle in closed position, 34½" long with handle in open position, 23" high with handle in upright position
- ⅜" cut • Made in USA

Item #405999
Mfg. #47713
Cs Pk 1 x 1 ea
Cs Wt 17.80 lb

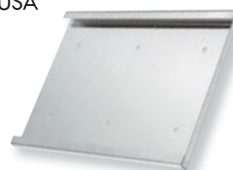

Wall Bracket for Potato Cutter
Item #399876
Mfg. #45682
Cs Pk 1 x 1 ea
Cs Wt 2.29 lb

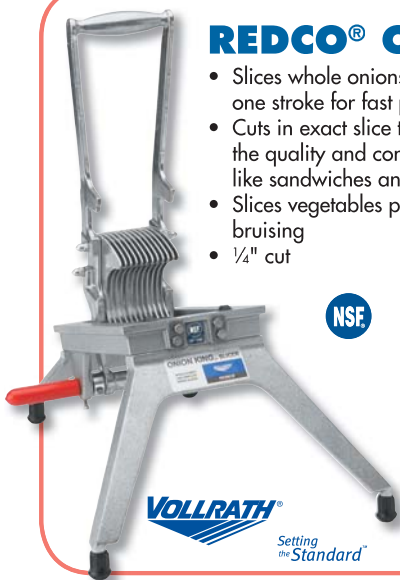

REDCO® ONION KING®

- Slices whole onions and other firm vegetables in one stroke for fast production
- Cuts in exact slice thicknesses every time, raising the quality and consistency of menu foods like sandwiches and cottage fries
- Slices vegetables perfectly without crushing or bruising
- ¼" cut



Complete Unit
Item #378472
 Mfg. #501N
 Cs Pk 1 x 1 ea
 Cs Wt 12.80 lb

Blade Assembly Only
Item #378473
 ¼" cut (11 blades)
 Mfg. #511
 Cs Pk 1 x 1 set
 Cs Wt 1.00 lb



EASY FLOWERING ONION™ CUTTER

- Produces high profit specialties fast and easy
- Just one stroke turns a colossal onion into a colossal, flowering favorite – then batter, bread and deep fry
- Adapter base lets you use smaller onions
- All-metal construction

Item #423076
 Mfg.# 55700
 Cs Pk 1 x 1 ea
 Cs Wt 20.00 lb



FOOD EQUIPMENT TIPS

The equipment in your kitchen should meet industry and regulatory standards. The following are some standard NSF requirements for food prep and storage equipment.

- Food Contact and food-splash surfaces must be easy to reach, easy to clean, nontoxic, non-absorbent, corrosion resistant, non-reactive to food or cleaning and should not leave a color, odor or taste to food.
- Should be rounded with tightly sealed edges and corners.
- Should be designed with solid and liquid waste traps that are easy to remove.

CONSIDER REPLACING ITEMS IF:

- They are worn out
- They no longer meet local health codes
- They make it more difficult to adhere to your operation's HACCP plan



EASY LETTUCEKUTTER™

- Scalloped blades and clean slicing action cut 1" squares with no crushing and no bruising
- Angled, cast aluminum legs with no-slip feet provide stable cutting platform
- Manual locking pin keeps pusher block safely in place until operator releases for cutting
- Interlocked blades avoid flexing
- Cleanup is easy

Item #423075
 Mfg.# 55650
 Cs Pk 1 x 1 ea
 Cs Wt 22.00 lb



KITCHEN

SALAD SPINNERS

- Heavy duty
- Can spin both clockwise and counter-clockwise
- FDA approved plastic
- Convenient side handles allow for quick and safe transport
- Comfortable finger grip handle on the crank maximizes productivity and minimizes operator fatigue
- Crank shaft is rust resistant commercial grade aluminum
- Cs Pk 1 x 1 ea

Item #	Mfg. #	Description	Cs Wt
504224	90012	2½ gal (2-3 heads of lettuce)	9.00 lb
423510	90005	5 gal (5-6 heads of lettuce)	13.65 lb



#90005

#90012



FIRM GRIP™ UTENSILS

- The right tool for the job
- Ergonomic, soft grip handles make sure work of intricate tasks
- Non-slip grips provide comfort and safety
- Cs Pk 1 x 1 ea

Item #	Mfg. #	Description	Cs Wt
A. 423853	E5613	Bagel Cutter	0.35 lb
B. 423854	E5627	Can Opener, Hand Held	0.50 lb
C. 423855	E5601	Straight Peeler	0.20 lb
D. 439272	E5602	Y Peeler, Straight Edge	0.21 lb
E. 423856	E5603	Cheese Plane	0.25 lb
F. 423858	E5604	Zester/Lemon Peeler	0.25 lb
G. 423859	E5606	Apple Corer	0.25 lb
H. 423860	E5607	Tomato Stem Corer	0.25 lb
I. 423861	E5616	Grater, Medium Holes	0.50 lb
J. 438957	E5614	Garlic Press	0.44 lb

GARLIC PRESS

- Self-cleaning

Item #504859
Mfg. #GP-1
Cs Pk 12 x 1 ea
Cs Wt 5.38 lb
Sold in case pack or eaches.



SQUARE GRATER

- Stainless steel w/4 grating surfaces
- 4" x 4" x 9" h

Item #380462
Mfg. #SG201
Cs Pk 12 x 1 ea
Cs Wt 10.00 lb
Sold in case pack or eaches.



GRATER

- Stainless steel
- 4-sided
- 4" x 4" x 9" h

Item #482357
Mfg. #GR-449
C. Pk 12 x 1 ea
Cs Wt 10.00 lb
Sold in case pack or eaches.



MANDOLINE SLICER SET

- Includes stainless steel blade set (straight blade, waffle blade and julienne blade) and hand guard

Item #504865
Mfg. #MDL-15
Cs Pk 8 x 1 ea
Cs Wt 31.80 lb
Sold in case pack or eaches.



SAFE HANDS™ MANDOLINS

- Stainless steel frame
- Safe Hands™ food holder protects hands and fingers
- 7 interchangeable blade cartridges
- Folding, slip resistant legs for easy storage
- Limited lifetime warranty

Ceramic Straight Blade
• Includes exclusive stay-sharp Advanced Ceramic™ straight blade cartridge

Item #483084
Mfg. #200441C
Cs Pk 4 x 1 ea
Cs Wt 19.00 lb
Sold in case pack or eaches.

Stainless Steel Blade
• Stainless steel straight blade cartridge

Item #483083
Mfg. #200441
Cs Pk 4 x 1 ea
Cs Wt 19.00 lb
Sold in case pack or eaches.



DUAL DIRECTION HAND-HELD MANDOLIN

- Double-edge, Advanced Ceramic™ blade
- Includes hand guard
- Dishwasher safe
- Limited lifetime warranty

Item #483087
Mfg. #200819
Cs Pk 6 x 1 ea
Cs Wt 4.00 lb
Sold in case pack or eaches.



SIMPLY BETTER™ MEAT TENDERIZERS

JACCARD
DESIGNED FOR THE PROFESSIONAL CHEF

- Exclusive, removable cartridge design for easy cleaning
- Stainless steel knife blades penetrate meat in seconds
- Durable, sturdy stainless steel columns
- Limited lifetime warranty • Cs Pk 6 x 1 ea



Item #	Mfg. #	Description	Cs	Pk	Cs Wt
483081	200315NS	15 Blade	6	1 ea	6.00 lb
483082	200345NS	45 Blade	6	1 ea	7.00 lb

Sold in case pack or eaches.

MEAT TENDERIZER

- Wood handle
- 2 3/4" x 2 3/4" x 3" mallet

Item #476377
 Mfg. #MT-AL
 Cs Pk 12 x 1 ea
 Cs Wt 12.50 lb

update
 international



MEAT GRINDER

- Heavy duty #10
- Made of rugged cast iron
- Self sharpening stainless steel blades
- Two high-grade steel cutting plates
- Easy to clean

Item #482753
 Mfg. #MG100
 Cs Pk 1 x 1 ea
 Cs Wt 10.10 lb

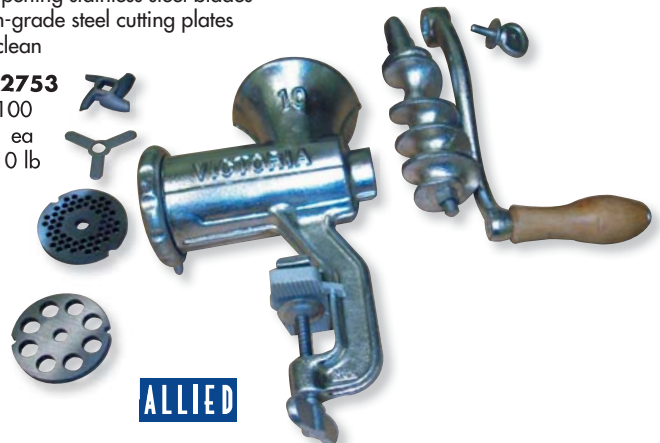

MEAT TENDERIZERS

- Original, authentic hand-held meat tenderizer
- Stainless steel knife blades penetrate meat in seconds
- Durable, sturdy stainless steel columns
- Dishwasher safe
- Protective cover included
- Limited lifetime warranty

JACCARD
DESIGNED FOR THE PROFESSIONAL CHEF



Item #	Mfg. #	Description	Cs	Pk	Cs Wt
483079	200316	16 Blade	6	1 ea	4.00 lb
483080	200348	48 Blade	6	1 ea	7.00 lb

Sold in case pack or eaches.

MEAT TENDERIZERS

- Cast aluminum tenderizer has one side coarse prongs, one side smooth

Item # 423239
 Mfg. #3005
 Cs Pk 1 x 1 ea
 Cs Wt 1.10 lb

- Cast aluminum tenderizer with wood handle has one side coarse prongs, one side fine prongs

Item #380445
 Mfg. #3016
 Cs Pk 12 x 1 ea
 Cs Wt 11.50 lb

Sold in case pack or eaches.



TABLECRAFT
 EVERY WARE, EVERY DAY.

CHEESE CUTTER

VOLLRATH
 Setting the Standard™

- Chrome plated cheese cutter
- Adjustable rust-proof wire allows you to slice block cheese to any thickness
- 5" wide, 4" cutting width

Item #487202
 Mfg. #47700
 Cs Pk 12 x 1 ea
 Cs Wt 7.08 lb

Sold in case pack or eaches.



ADVANCED CERAMIC™ Y PEELER

- Guaranteed to keep its factory-sharp edge up to 10 years
- Ultra pure ceramic composition helps prevent browning of fresh fruits and vegetables
- Eliminates transfer of metallic ions that can alter the taste and smell of fresh foods
- Ergonomic, soft grip, slip-resistant handle provides unparalleled balance and comfort
- Dishwasher safe
- Limited lifetime warranty

Item #483086
 Mfg. #200817
 Cs Pk 12 x 1 ea
 Cs Wt 2.00 lb

Sold in case pack or eaches.

ADVANCED CERAMIC

JACCARD
DESIGNED FOR THE PROFESSIONAL CHEF



SIMPLY BETTER™ MEAT MALLET

- 4 mallets in 1
- 4 interchangeable, customized tenderizing disks
- Includes flattener plus fine, medium and coarse disks
- Disks conveniently nest in mallet head for easy storage
- Soft grip ergonomic handle
- Dishwasher safe
- Limited lifetime warranty

JACCARD
DESIGNED FOR THE PROFESSIONAL CHEF

Item #483085
 Mfg. #200414A
 Cs Pk 12 x 1 ea
 Cs Wt 17.25 lb

Sold in case pack or eaches.



PEELERS

- 6" long
- Ekco® brand
- Cs Pk 12 x 1 ea

Item #	Mfg. #	Description	Cs	Pk	Cs Wt
380455	44	Tempered Steel Blade	12	1 ea	0.88 lb
537754	45	Stainless Steel Blade	12	1 ea	0.88 lb

Sold in case pack or eaches.

TABLECRAFT
 EVERY WARE, EVERY DAY.

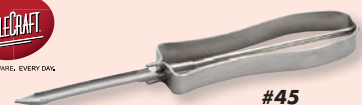



#PR-6C

#PR-6BC



VEGETABLE PEELERS

- Floating blade removes only peel
- Use with left or right hand
- Cs Pk 24 x 1 ea

Item #	Mfg. #	Description	Cs Wt
476397	PR-6BC	Non-Slip Plastic Handle w/Stainless Steel Blade	1.37 lb
476398	PR-6C	Metal Handle w/Carbon Steel Blade	1.63 lb

Sold in case pack or eaches.

STRAIGHT PEELER

- Ergonomic soft grip handle
- Dishwasher safe

Item #482345
Mfg. #EGU-5
Cs Pk 12 x 1 ea
Cs Wt 2.84 lb

Sold in case pack or eaches.



BEAN MASHER

- Chrome plated
- Black cool-to-touch handle
- 6" square face, 24" long

Item #476690
Mfg. #2455
Cs Pk 4 x 1 ea
Cs Wt 9.66 lb

Sold in case pack or eaches.



POTATO MASHER

- All stainless steel round face
- 24" long

Item #380457
Mfg. #4424
Cs Pk 12 x 1 ea
Cs Wt 17.00 lb

Sold in case pack or eaches.



MASHERS

- Nickel plated
- Wooden handle
- Cs Pk 12 x 1 ea

#PMSQ-18

#PMRD-24



Item #	Mfg. #	Description	Cs Wt
476395	PMSQ-18	18" - Square	12.50 lb
476394	PMRD-24	24" - Round	13.00 lb

Sold in case pack or eaches.

BUTTER SPREADER

- Roller design promotes even, consistent application on all sorts of menu items
- 5½"w x 8"d x 3½"h

Item #430984
Mfg. #8150-RS
Cs Pk 1 x 1 ea
Cs Wt 3.00 lb



"Exceeding your expectations"



SERRATOR

- Stainless steel blade, brass rivets and wood handle
- 7" blade, 4¾" x 7¼" OA

Item #484784
Mfg. #WSER-7
Cs Pk 12 x 1 ea
Cs Wt 8.50 lb

Sold in case pack and eaches.



EGG SLICER

- Die-cast aluminum
- Hinged piano wire
- Oval or round slices

Item #476342
Mfg. #ES-AL
Cs Pk 12 x 1 ea
Cs Wt 4.10 lb

Sold in case pack or eaches.



3-N-1 EGG SLICER

- Two slicing discs create picture perfect round or oval slices as well as wedges
- Compact and durable plated cast zinc alloy upper with a nylon and silicone base
- 4½" x 3¾" x 1½"h

Item #502146
Mfg. #FESW
Cs Pk 6 x 1 ea
Cs Wt 0.27

Sold in case pack or eaches.



KITCHEN

APPLE DIVIDER/CORER

- Aluminum
- With color box

Item #504813
Mfg. #AAD-12
Cs Pk 12 x 1 ea
Cs Wt 5.28 lb

Sold in case pack or eaches.



POTATO RICER

- Stainless steel

Item #504880
Mfg. #PR-16
Cs Pk 6 x 1 ea
Cs Wt 20.40 lb

Sold in case pack or eaches.



POTATO PRESS

- Heavy duty

Item #482813
Mfg. #PP100
Cs Pk 2 x 1 ea
Cs Wt 2.80 lb

Sold in case pack or eaches.





FOOD MILL

- Stainless steel
- 2 qt food mill
- Includes 4 discs
- 8" dia

Item #504945

Mfg. #SVM-8

Cs Pk 8 x 1 set

Cs Wt 23.12 lb

Sold in case pack or eaches.



STRAINER

- Stainless steel
- Round wooden handle
- Reinforced double mesh
- 11½" dia, 5"d

Item #481091

Mfg. #SHD-12/SS

Cs Pk 6 x 1 ea

Cs Wt 17.60 lb

Sold in case pack or eaches.



PAN STRAINER

- Aluminum with chrome steel handle
- Hanging hook prevents sinking to bottom of pan
- 10" dia top

Item #476405

Mfg. #PSA-10

Cs Pk 12 x 1 ea

Cs Wt 12.98 lb

Sold in case pack or eaches.



BOUILLON STRAINER

- 18/8 stainless steel mesh and rim
- 9¼" dia, fine mesh

Item #380443

Mfg. #349

Cs Pk 6 x 1 ea

Cs Wt 8.00 lb

Sold in case pack or eaches.



EVERY WARE, EVERY DAY.

REINFORCED STRAINER

- Double mesh, tinned, wooden handles
- 11½" dia

Item #380453

Mfg. #1023

Cs Pk 6 x 1 ea

Cs Wt 17.75 lb

Sold in case pack or eaches.



EVERY WARE, EVERY DAY.

STRAINERS

- Double mesh, tinned, wooden handles
- Cs Pk 12 x 1 ea

Item #	Mfg. #	Dia/Mesh	Cs Wt
380447	82	6¼", Fine	8.25 lb
380448	84	8", Fine	7.25 lb
380449	87	10¼", Fine	15.75 lb
380450	96	6¼", Medium	5.00 lb
380451	98	8", Medium	7.75 lb
380452	99	10¼", Medium	13.25 lb

Sold in case pack or eaches.



ALUMINUM STRAINER

- Aluminum strainer is sturdy and will not rust
- Hook and handle rest on the rim of pot or sink
- Diameter of holes is 5/64"
- 5 qt capacity
- 10¾" x 5½"

Item #397867

Mfg. #4605

Cs Pk 4 x 1 ea

Cs Wt 5.65 lb

Sold in case pack or eaches.



Setting the Standard

CHINA CAP STRAINER

- Extra dent-resistant 3004 aluminum alloy
- Fitted with two hooks for hanging over the edge of a stock pot
- Diameter of the holes is 1/16"
- 5½ qt capacity

Item #397806

Mfg. #4700

Cs Pk 4 x 1 ea

Cs Wt 7.26 lb

Sold in case pack or eaches.



Setting the Standard



CHINA CAP STRAINER

- Heavy duty stainless steel
- 4 quart capacity
- 10" dia
- Cs Pk 12 x 1 ea
- Cs Wt 22.00 lb

Item #	Mfg. #	Description
380454	1610	Coarse Mesh
454346	1710	Fine Mesh

Sold in case pack or eaches.



EVERY WARE, EVERY DAY.



Setting the Standard



ALUMINUM COLANDERS

- Heavy gauge, impact resistant aluminum
- Full-ring welded base and riveted handles

Item #	Mfg. #	Description	Cs Pk	Cs Wt
530521	68298	11 qt capacity	2 x 1 ea	9.50 lb
368176	68350	16 qt capacity	1 x 1 ea	6.20 lb

Sold in case pack or eaches.



FOOTED COLANDERS

- Stainless steel, .4mm
- Mirror finish
- Tube handles
- Cs Pk 12 x 1 ea



Item #	Mfg. #	Description	Cs Wt
380420	708	8 qt capacity	16.00 lb
380424	713	13 qt capacity	23.00 lb

Sold in case pack or eaches.

COLANDER

- Aluminum 2mm
- With handles and base
- 16 quart

Item #482269
Mfg. #ACO-16
Cs Pk 4 x 1 ea
Cs Wt 14.00 lb
Sold in case pack or eaches.



SKIMMERS

- Nickel plated
- 6" dia

Item #399870
Mfg. #3306
Cs Pk 24 x 1 ea
Cs Wt 8.25 lb
Sold in case pack or eaches.



#3306

- Square with stainless steel & tin plated fine mesh
- 5" x 6 1/2" x 18 1/4"

Item #399868
Mfg. #2675
Cs Pk 12 x 1 ea
Cs Wt 5.00 lb
Sold in case pack or eaches.



#2675



EVERY WARE, EVERY DAY.

SKIMMER

- Heavy-duty one-piece construction
- Stainless steel
- Mirror-finish blade, satin-finish handle
- 6" dia, 12 3/8" long handle

Item #437509
Mfg. #46970
Cs Pk 6 x 1 ea
Cs Wt 6.45 lb
Sold in case pack or eaches.



Setting the Standard



SKIMMERS

- Round mesh bowl
- Cs Pk 6 x 1 ea

Item #	Mfg. #	Description	Cs Wt
482834	SRD6	6" dia	4.50 lb
482835	SRD8	8" dia	6.00 lb

Sold in case pack or eaches.



SKIMMER

- Stainless steel
- Round
- 2 piece construction
- 5 1/2" dia

Item #476428
Mfg. #SSK-55
Cs Pk 12 x 1 ea
Cs Wt 5.92 lb
Sold in case pack or eaches.



TURNER

- Smooth, easy to grip wood handle
- Stainless steel, perforated blade
- Brass rivets
- 14" long OA, 10"l x 3"w blade

Item #482445
Mfg. #WTPF-10
Cs Pk 12 x 1 ea
Cs Wt 5.25 lb
Sold in case pack or eaches.



TURNER

- Stainless steel
- Rigid handle
- Flexible slotted blade
- 14" long

Item #476429
Mfg. #STPF-14
Cs Pk 12 x 1 ea
Cs Wt 3.00 lb
Sold in case pack or eaches.



SOLID TURNER

- Stainless steel blade, brass rivets and wood handle
- 8"l x 4"w blade, 15 3/4" long OA

Item #484780
Mfg. #WTSD-48
Cs Pk 12 x 1 ea
Cs Wt 9.00 lb
Sold in case pack or eaches.

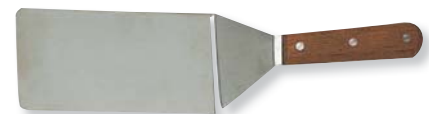



#WPF-13

#WPF-21

POT FORKS

- Stainless steel blades
- Easy to grip wood handles with brass rivets
- Cs Pk 12 x 1 ea

Item #	Mfg. #	Description	Cs Wt
476445	WPF-13	13" long	2.64 lb
476446	WPF-21	21" long	5.00 lb

Sold in case pack and eaches.



DOUGH SCRAPER

- Stainless steel blade
- Wood handle with brass rivets
- Blade, 6" x 3"

Item #482460
Mfg. #WDS-36
Cs Pk 12 x 1 ea
Cs Wt 4.40 lb
Sold in case pack or eaches.



STAINLESS STEEL SKEWERS

- Oval stainless steel wire
- Cs Pk 5 x 1 dz

Item #	Mfg. #	Description	Cs Wt
380464	310	10" long	3.00 lb
380465	312	12" long	3.20 lb

Sold in case pack or eaches.



STEAK WEIGHTS

- Meats cook faster without curling
- Wood handle stays cool
- Cs Pk 12 x 1 ea

Item #	Mfg. #	Description	Cs Wt
380444	3004	8½" x 4¼" x 1½" Aluminum	15.00 lb
380446	3033	8½" x 4¼" x 2½" Cast Iron	34.00 lb

Sold in case pack or eaches.



STEAK WEIGHTS

- Cast iron
- Cs Pk 12 x 1 ea



Item #	Mfg. #	Description	Cs Wt
504946	SWA-2	4¼" x 8¼"	27.00 lb
504947	SWA-9	5¼" x 9"	33.00 lb

Sold in case pack or eaches.

OIL MOP

- 13" long OA

Item #504866
Mfg. #OM-13
Cs Pk 12 x 1 ea
Cs Wt 1.90 lb
Sold in case pack or eaches.



RUBBER SCRAPER

- Flexible
- 16" long

Item #482386
Mfg. #RSC-16
Cs Pk 12 x 1 ea
Cs Wt 2.70 lb
Sold in case pack or eaches.



PAN SCRAPER

- Made of flexible polyethylene
- Handy, indispensable kitchen tool

Item #482582
Mfg. #1345-05
Cs Pk 72 x 1 ea
Cs Wt 5.00 lb
Sold in case pack and eaches.



BOWL SHAPED HIGH HEAT SILICONE SCRAPERS

- Heat resistant up to 500°F
- Cs Pk 12 x 1 ea

Item #	Mfg. #	Description	Cs Wt
504891	PSG-10	10"	1.92 lb
504892	PSG-14	14"	3.50 lb
504893	PSG-16	16"	3.84 lb

Sold in case pack or eaches.



FLAT HIGH HEAT SILICONE SCRAPERS

- Heat resistant up to 600°F
- Cs Pk 24 x 1 ea

Item #	Mfg. #	Description	Cs Wt
504894	PSH-10	10½"	4.07 lb
504895	PSH-14	14"	6.00 lb
504896	PSH-16	16¼"	6.47 lb

Sold in case pack or eaches.



HIGH HEAT SPOON-STIR™ / SPATULA



TRAEX
A Libby FOODSERVICE Company

- Non-scratching silicone blades resist heat up to 400°F, making them ideal for use with non-stick cookware
- Handle and blade are molded together to form a sanitary seal
- Spatula's blade notch makes scraping down sides of pans easy
- Cs Pk 6 x 1 ea

Item #	Mfg. #	Description	Cs Wt
Spoon-Stir™			
A. 429445	809-0605	Spoon-Stir™, 11¼" long	2.00 lb
B. 429446	813-0605	Spoon-Stir™, 14½" long	2.25 lb
C. 429447	816-0605	Spoon-Stir™, 16⅞" long	2.50 lb
Spatulas			
D. 429438	709-0605	Spatula, 10½" long	2.00 lb
E. 429439	713-0605	Spatula, 14½" long	2.25 lb
F. 429442	716-0605	Spatula, 16½" long	2.50 lb

Sold in case or eaches.



HIGH TEMPERATURE SPATULAS & SOFTSPOON™

- Non-scratching silicone blade and nylon handle resist heat up to 500°F
- Handle and blade are molded together for a sanitary seal
- Molded rubber nubs keep blade off counter
- Dishwasher safe
- Cs Pk 6 x 1 ea



Item #	Mfg. #	Description	Cs Wt
Spatulas			
429543	52010	10" long	1.52 lb
393099	52023	13½" long	2.40 lb
429544	52026	16½" long	2.58 lb
SoftSpoons™			
429545	58110	10" long	1.60 lb
429548	58123	13½" long	2.40 lb
429551	58126	16½" long	2.57 lb

Sold in case pack or eaches.

VOLLRATH
Setting the Standard™



KITCHEN

SOFTSPOON™ SPATULAS

- Spoon shaped blade for convenient scooping of food products
- Thermoplastic blade and strong polypropylene handle molded together
- Flexible blade retains its shape up to 212°F (100°C)
- Dishwasher safe
- Cs Pk 6 x 1 ea



Item #	Mfg. #	Description	Cs Wt
429539	52109	9½" long	0.72 lb
393095	52113	13½" long	1.67 lb
429541	52116	16½" long	1.68 lb

Sold in case pack or eaches.



VOLLRATH
Setting the Standard™

SPATULA/SCRAPERS

- Thermoplastic blade and strong polypropylene handle molded together
- Flexible blade retains its shape up to 212°F (100°C)
- Dishwasher safe
- Cs Pk 6 x 1 ea



Item #	Mfg. #	Description	Cs Wt
429528	52009	9⅞" long	0.60 lb
429530	52013	13⅞" long	1.17 lb
429536	52016	16⅞" long	1.38 lb

Sold in case pack or eaches.



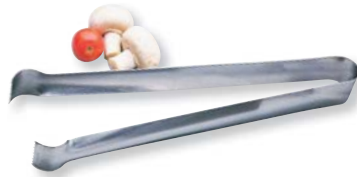

ECONOMY POM TONGS

- Stainless steel

Item #	Mfg. #	Description	Cs Pk	Cs Wt
379722	47106	6" long	60 x 1 ea	4.20 lb
379724	47109	9" long	48 x 1 ea	5.76 lb
379726	47112	12" long	12 x 1 ea	2.28 lb

Sold in case pack or eaches.



ECONOMY UTILITY TONGS

- Stainless steel
- Cs Pk 12 x 1 ea

Item #	Mfg. #	Description	Cs Wt
379727	47110	9½" long	2.16 lb
379730	47113	12" long	2.67 lb
379732	47116	16" long	3.67 lb

Sold in case pack or eaches.

KITCHEN

Scalloped Grip

Flat Paddle Grip



SCALLOPED TONGS

- Stainless steel
- Heavy duty, hinged
- Replaceable spring
- Cs Pk 12 x 1 ea

Item #	Mfg. #	Description	Cs Wt
379453	4409HD	Scalloped Grip, 9" long	3.50 lb
379454	4412HD	Scalloped Grip, 12" long	4.00 lb
459648	4416HD	Scalloped Grip, 16" long	5.00 lb
379455	4409HDL	Scalloped Grip, 9" long, w/Lock	3.50 lb
379456	4412HDL	Scalloped Grip, 12" long, w/Lock	4.00 lb
379458	6416HD	Flat Paddle Grip, 16" long	5.50 lb

Sold in case pack or eaches.



HEAVY-DUTY UTILITY TONGS

- Heavy gauge stainless steel
- Cs Pk 12 x 1 ea

Item #	Mfg. #	Length	Cs Wt
379749	47309	9½" long	3.73 lb
379751	47312	12" long	4.08 lb
379752	47316	16" long	5.40 lb

Sold in case pack or eaches.

HEAVY-DUTY ONE-PIECE UTILITY TONGS

- Special stainless steel for enhanced performance
- Unique springless design eliminates bacteria-prone traps
- Made in USA
- Cs Pk 12 x 1 ea



Setting the Standard



Item #	Mfg. #	Length	Cs Wt
457894	4780910	9½" long	3.00 lb
457895	4781210	12" long	3.60 lb
457896	4781610	16" long	4.80 lb

Sold in case pack or eaches.

SPAGHETTI TONGS

- Perfect for spaghetti, other pasta or bakery items
- One-piece, heavy duty stainless steel construction
- Springless
- 6" long

Item #476427
Mfg. #SPT-6
Cs Pk 24 x 1 ea
Cs Wt 1.90 lb
Sold in case pack or eaches.



KITCHEN SMALLWARES GUIDE FOR 100

Products	Quantity
Storage Containers	
Dry	18
Cold	54
Meat	18
Insulated Coffee Tank (3.5 gal)	1
Multipurpose Rubber Matting (26" x 50")	1 roll
Safety Mats	3-6 each
Ice Cream Scoops (assorted sizes)	6
Juice Dispenser	1-2
Juice Extractor	1
Coffee Making Equipment	2
Coffee Decanters (Regular & Decaf)	4

Products	Quantity
Silver Storage Bins	3
Sauce Pans w/Covers (assorted sizes)	6
Sauce Pots w/Covers (assorted sizes)	4
Stock Pots w/Covers (assorted sizes)	8
Double Boilers (8 & 12 qt)	2
Bake Pans (assorted sizes)	24
Roast Pans (assorted sizes)	2
China Cap Strainer (9")	1
Colander	2
Strainer (6", 8", 10" & 12")	6
Service Pans (½, ⅓, ¼ & ⅛)	24
Fry Pans (8", 10", 12" & 14")	24

Products	Quantity
Egg Poacher	1
Steak Weight	1
Thermometers:	5
Thermo-Pins (12"-18")	4-6
Basting Spoons	17
Ladles (1-24 oz assorted)	15
Paddle (30-48")	1
Tongs (6", 9" & 12")	11
Turners (assorted)	4
Butter Spreader	1
Skimmers (4½" & 6")	1
Cutting Boards	15

MULTI-PACK COLOR-CODED NSF UTILITY TONGS

- 9½" (24.1 cm) with scalloped edges
- 6 color-coded tongs – one each of Black, Blue, Red, Yellow, Tan and Green

Item #457897

Mfg. #4780911

Cs Pk 3 x 1 ea

Cs Wt 6.00 lb

Sold in case pack or eaches.



KOOL-TOUCH® SCALLOPED TONGS

- 20 gauge stainless steel
- Unique one-piece springless design
- Kool-Touch® color-coded handles are heat resistant to 180°F
- Color: Black
- Cs Pk 12 x 1 ea



Setting the Standard™



Item #	Mfg. #	Description	Cs Wt
460956	4780920	9½"	3.96 lb
482548	4781620	16"	5.76 lb

Sold in case pack or eaches.

TONGS

- Polycarbonate
- Dishwasher safe
- Ideal for salad and fruit bars
- 9" black



Item #482383
Mfg. #PCT-9BK
Cs Pk 12 x 1 ea
Cs Wt 3.14 lb
Sold in case pack or eaches.

SPRING TONGS

- 12" long one-piece stainless steel construction
- Scalloped gripping edges
- Heat resistant non-slip black handle
- Easy to clean

Item #482440

Mfg. #TOPP-12

Cs Pk 12 x 1 ea

Cs Wt 4.23 lb

Sold in case pack or eaches.



SPRING TONGS

- Stainless steel
- Heavy duty
- Coiled spring
- Cs Pk 12 x 1 ea

Item #	Mfg. #	Description	Cs Wt
482144	ST-9HD/CS	9" long	3.59 lb
482143	ST-12HD/CS	12" long	4.20 lb

Sold in case pack or eaches.

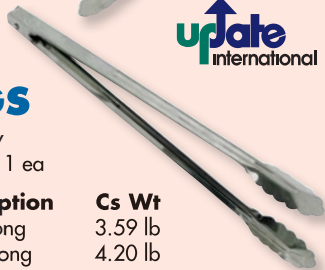

SPATULA/MIXING PADDLE

- Long handle makes it perfect for stirring, mixing and cleaning kettles, vats and large pots
- Standard nylon blade (300°F) with nylon handle
- 40" long overall

Item #380829

Mfg. #4035200

Cs Pk 6 x 1 ea

Cs Wt 6.15 lb

Sold in case pack or eaches.



MIXING PADDLES

- Stainless steel
- Mirror polished finish
- Cs Pk 12 x 1 ea

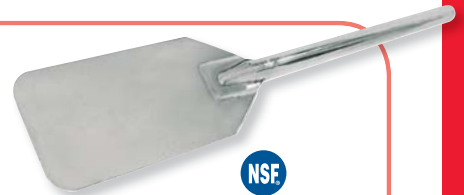

Item #	Mfg. #	Description	Cs Wt
476375	MPS-36	36" long	11.42 lb
476376	MPS-48	48" long	15.00 lb

Sold in case pack or eaches.

WOOD MIXING PADDLES

- Cs Pk 6 x 1 ea



Item #	Mfg. #	Description	Cs Wt
484782	MPW-36	36" Long	14.60 lb
484783	MPW-48	48" Long	17.70 lb

Sold in case pack and eaches.

KETTLE WHIP

- 18/8 stainless steel fully soldered construction
- 48" long



Item #476367

Mfg. #KW-48

Cs Pk 2 x 1 ea

Cs Wt 6.00 lb

Sold in case pack or eaches.



MIXING SPOONS

- Birchwood
- Standard wooden spoon for light duty use such as light batters
- Cs Pk 12 x 1 ea



Item #	Mfg. #	Description	Cs Wt
476448	WSP-14	14" long	1.56 lb
476449	WSP-18	18" long	1.95 lb

Sold in case pack or eaches.

PIANO WIRE WHIPS

- Light gauge wire
- Perfect for whipping delicate sauces and toppings
- Cs Pk 12 x 1 ea



Item #	Mfg. #	Description	Cs Wt
482384	PW-12	12" long	4.62 lb
482385	PW-16	16" long	6.20 lb

Sold in case pack or eaches.

FRENCH WHIP

- Light and balanced for perfect mixing, stirring and whipping of batters, sauces, eggs and souffles
- High quality chrome-plated brass handle with high quality stainless steel spring wire loop construction
- 36" long

Item #380830

Mfg. #40681

Cs Pk 2 x 1 ea

Cs Wt 4.20 lb

Sold in case pack or eaches.





NYLON HANDLE FRENCH WHIPS

- Thicker wires for mixing mashed potatoes and heavy products
- Stainless steel
- The one-piece handle is completely sealed with no crevices to collect food or bacteria
- Reinforcement center wire on all sizes
- Color coded aqua handle
- Cs Pk 12 x 1 ea

Item #	Mfg. #	Length	Cs Wt
432396	47091	12"	4.84 lb
432397	47092	14"	6.28 lb
432398	47093	16"	7.20 lb
432399	47094	18"	8.14 lb
432400	47097	24"	10.82 lb

Sold in case pack or eaches.



NYLON HANDLE PIANO WHIPS

- Fine wire construction for blending thin foods or consommé
- Stainless steel
- Completely sealed, one-piece handle
- Reinforcement center wire on all sizes
- Color coded purple handle
- Cs Pk 12 x 1 ea

Item #	Mfg. #	Length	Cs Wt
432401	47002	10"	4.02 lb
432402	47003	12"	4.66 lb
432403	47004	14"	5.11 lb
432404	47005	16"	5.85 lb
432405	47006	18"	6.34 lb

Sold in case pack or eaches.

STAINLESS STEEL ONE-PIECE LADLES

- Mirror-finished stainless steel
- One-piece construction resists breaking, is more sanitary, and has no dirt-catching cracks or crevices
- Capacity marked on hooked handle to ensure portion control

Item #	Mfg. #	Capacity	Handle		Cs Pk	Cs Wt
			Length			
379655	46811	1 oz	11"		24 x 1 ea	3.84 lb
379656	46812	2 oz	11"		24 x 1 ea	5.15 lb
379657	46814	4 oz	12½"		12 x 1 ea	3.84 lb
379658	46816	6 oz	12¾"		12 x 1 ea	4.68 lb
379659	46818	8 oz	12½"		12 x 1 ea	4.91 lb

Sold in case pack or eaches.

KOOL-TOUCH® BLACK AND COLOR-CODED LADLES

- Stainless steel
- Portion control with capacities permanently stamped on hooked handle
- Cool grip for comfort and safety – resists heat up to 180°F – dishwasher safe
- Color-coded handles take the guesswork out of size selection
- Cs Pk 12 x 1 ea

Item #	Mfg. #	Color	Capacity	Handle		Cs Wt
				Length		
381762	58011	Black	1 oz	10"		1.92 lb
379783	58022	Black	2 oz	9⅞"		2.28 lb
381766	58322	Blue	2 oz	9⅞"		2.40 lb
381763	58033	Black	3 oz	12⅝"		4.56 lb
379789	58044	Black	4 oz	12⅝"		4.92 lb
381767	58344	Gray	4 oz	12⅝"		5.40 lb
381764	58055	Black	6 oz	12⅝"		5.64 lb
381768	58355	Teal	6 oz	12⅝"		5.88 lb
381765	58066	Black	8 oz	12⅝"		6.12 lb

Sold in case pack or eaches.

ECONOMY TWO-PIECE LADLES

- Stainless steel
- Handle is hooked for hanging and marked with capacity for portion control

Item #	Mfg. #	Capacity	Handle		Cs Pk	Cs Wt
			Length			
379664	46901	1 oz	10⅞"		24 x 1 ea	4.70 lb
460082	46915	1½ oz	8⅞"		12 x 1 ea	1.86 lb
379666	46902	2 oz	11¼"		24 x 1 ea	5.21 lb
381691	46903	3 oz	11½"		24 x 1 ea	6.00 lb
379667	46904	4 oz	12½"		12 x 1 ea	3.60 lb
379668	46906	6 oz	12½"		12 x 1 ea	3.85 lb
379669	46908	8 oz	12¾"		12 x 1 ea	4.22 lb
379671	46912	12 oz	15½"		12 x 1 ea	6.13 lb

Sold in case pack or eaches.

STAINLESS STEEL ONE-PIECE LADLES

- Durable 18/8 stainless steel
- Choice of most chefs
- Cs Pk 12 x 1 ea

Item #	Mfg. #	Capacity	Handle		Cs Wt
			Length		
482367	LOP-10	1 oz	10¼"		2.00 lb
482368	LOP-20	2 oz	10½"		3.20 lb
482369	LOP-30	3 oz	11"		3.25 lb
482370	LOP-40	4 oz	12½"		3.25 lb
482371	LOP-60	6 oz	13"		5.00 lb

Sold in case pack or eaches.



update
International

KOOL-TOUCH® & STAINLESS LADLES

- One-piece construction for easy cleaning
- Capacities stamped on product for easy identification
- Heavy-gauge stainless steel shafts and bowls for long life
- Plastic-coated handles are heat resistant up to 180°F (82°C)
- Cs Pk 12 x 1 ea



Color-Coded

Item #	Mfg. #	Capacity	Length	Handle Color	Cs Wt
457859	4980120	1 oz	9 ⁷ / ₈ "	Black	2.92 lb
457863	4980230	2 oz	9 ⁷ / ₈ "	Blue	5.02 lb
457865	4980335	3 oz	12 ⁵ / ₈ "	Ivory	6.42 lb
457867	4980445	4 oz	12 ⁵ / ₈ "	Gray	7.10 lb
457868	4980655	6 oz	12 ⁵ / ₈ "	Teal	7.56 lb
457869	4980865	8 oz	12 ⁵ / ₈ "	Orange	8.40 lb

Stainless Steel Handle

Item #	Mfg. #	Capacity	Length	Cs Wt
457880	4980010	1/2 oz	6"	1.94 lb
458183	4980110	1 oz	9 ⁷ / ₈ "	2.80 lb
457883	4980210	2 oz	9 ⁷ / ₈ "	5.02 lb
457884	4980310	3 oz	12 ⁵ / ₈ "	6.42 lb
457885	4980410	4 oz	12 ⁵ / ₈ "	7.10 lb
457887	4980610	6 oz	12 ⁵ / ₈ "	7.56 lb

Sold in case pack or eaches.



Setting the Standard



ONE-PIECE OVAL COLOR-CODED SPOODLE®

- Mirror finished 20 gauge stainless steel shafts and bowls
- Capacities clearly stamped on shaft for easy size identification
- Textured surface prevents slippage while in use
- High temperature nylon handle – heat resistant to 450°F (232°C)
- Built-in stopper notch prevents Spoodle from sliding into food product
- Ergonomic design offers comfort and reduces hand fatigue
- Cs Pk 12 x 1 ea

Solid		Capacity	Length	Handle		Cs Wt
Item #	Mfg. #			Color		
457848	6412230	2 oz	13 ¹ / ₆ "	Blue		4.67 lb
457899	6412335	3 oz	13 ¹ / ₂ "	Ivory		5.15 lb
457852	6412445	4 oz	13 ¹ / ₆ "	Gray		5.51 lb
457856	6412655	6 oz	14 ³ / ₈ "	Teal		6.30 lb
457858	6412865	8 oz	14 ³ / ₄ "	Orange		6.90 lb
Perforated		Capacity	Length	Handle		Cs Wt
Item #	Mfg. #			Color		
457847	6422230	2 oz	13 ¹ / ₆ "	Blue		4.63 lb
457898	6422335	3 oz	13 ¹ / ₂ "	Ivory		5.01 lb
457851	6422445	4 oz	13 ¹ / ₆ "	Gray		5.31 lb
457855	6422655	6 oz	14 ³ / ₈ "	Teal		5.91 lb
457857	6422865	8 oz	14 ³ / ₄ "	Orange		6.59 lb

Sold in case pack or eaches.



HEAVY DUTY BASTING SPOONS

- Stainless steel
- Unique perforation and slot patterns for optimal draining
- Patented handle with unique turned-down design for unrivaled strength and comfort
- One-piece construction is durable and sanitary
- Satin-finish minimizes appearance of wear and hides finger prints
- Cs Pk 12 x 1 ea

Item #	Mfg. #	Length	Cs Wt
Solid			
457891	64403	13 ¹ / ₄ "	5.31 lb
457877	64406	15 ¹ / ₂ "	6.26 lb
Perforated			
457892	64404	13 ¹ / ₄ "	5.10 lb
457878	64407	15 ¹ / ₂ "	6.04 lb
Slotted			
457893	64405	13 ¹ / ₄ "	5.05 lb
458691	64408	15 ¹ / ₂ "	6.09 lb

Sold in case pack or eaches.



SPOODLE® UTENSILS WITH GRIP 'N SERV® HANDLES

- Ease of serving with a spoon and accurate portion control of a ladle
- Color-coded handle for no-guess size selection
- Stainless steel shaft and bowl
- Handle's thumb notch and stopper provide greater control
- Stopper prevents Spoodle® from sliding into pan when not in use
- Plastic handles are heat resistant to 230°F
- Cs Pk 12 x 1 ea

Item #	Mfg. #	Description	Grip Color	Cs Wt
Color-Coded Spoodle® Utensils				
379822	62172	Solid, 4 oz	Gray	3.48 lb
379819	62170	Perforated, 4 oz	Gray	3.48 lb
379826	62177	Solid, 6 oz	Teal	4.32 lb
379824	62175	Perforated, 6 oz	Teal	4.32 lb
Black Spoodle® Utensils				
379804	61157	Solid, 2 oz	Black	2.88 lb
379801	61155	Perforated, 2 oz	Black	3.00 lb
400244	61167	Solid, 3 oz	Black	3.12 lb
400246	61165	Perforated, 3 oz	Black	3.24 lb
379811	61172	Solid, 4 oz	Black	3.48 lb
379809	61170	Perforated, 4 oz	Black	3.48 lb
379815	61177	Solid, 6 oz	Black	4.32 lb
379814	61175	Perforated 6 oz	Black	4.32 lb
493180	61182	Solid, 8 oz	Black	4.80 lb
379816	61180	Perforated, 8 oz	Black	4.92 lb

Sold in case pack or eaches.



STAINLESS STEEL BASTING SPOONS WITH GRIP 'N SERV® HANDLES

- Made of 18-gauge stainless steel
- Thumb notch for comfortable use and to prevent the spoon from sliding into the pan
- Black plastic handles are heat resistant to 230°F
- Perforated, 14" long
- Cs Pk 12 x 1 ea

Item #	Mfg. #	Description	Cs Wt
452049	46945	Solid, 14" long	3.51 lb
452050	46946	Perforated, 14" long	3.40 lb

Sold in case pack or eaches.



STAINLESS STEEL BASTING SPOONS

- 18 gauge stainless steel
- Handle is deep grooved for strength
- Cs Pk 12 x 1 ea

Item #	Mfg. #	Description	Cs Wt
379679	46961	Solid, 11" long	3.12 lb
379687	46973	Solid, 13" long	3.48 lb
379698	46981	Solid, 15" long	3.96 lb
379680	46962	Perforated, 11" long	3.00 lb
379689	46975	Perforated, 13" long	3.48 lb
379700	46983	Perforated, 15" long	3.96 lb
379681	46963	Slotted, 11" long	3.00 lb
379690	46976	Slotted, 13" long	3.24 lb
379702	46985	Slotted, 15" long	3.72 lb

Sold in case pack or eaches.

HEAVY DUTY BASTING SPOONS WITH ERGO GRIP® HANDLES

- Heavy-gauge stainless steel shaft and bowls – resistant to corrosion
- One-piece construction is extremely durable and has no crevices to collect water or bacteria
- High-temperature, black nylon handles are heat resistant to 450°F
- Built-in stopper notch
- 3-sided spoon has one straight edge for cutting
- Cs Pk 12 x 1 ea



Item #	Mfg. #	Description	Cs Wt
452046	64130	Solid, 13 ³ / ₁₆ " long	4.79 lb
450797	64134	Slotted, 13 ³ / ₁₆ " long	4.62 lb
457846	64132	Perforated, 13 ³ / ₁₆ " long	4.64 lb
457843	64138	3-Sided Perforated, 13 ³ / ₁₆ " long	4.49 lb
452308	64136	3-Sided Solid, 13 ³ / ₁₆ " long	4.61 lb

Sold in case pack or eaches.

DISHERS

- Stainless steel construction
- Plastic color-coded handles and ergonomically correct thumb tab design
- Cs Pk 1 x 5 dz



Item #	Mfg. #	Size	Color	Capacity	Cs Wt
481083	DP-10	10	Cream	3¾ oz	27.00 lb
481081	DP-16	16	Blue	2¾ oz	26.00 lb

Sold in case pack only.



Setting the Standard™

DISHERS WITH ONE-PIECE COLOR-CODED HANDLES

- Welded stainless steel construction to prevent corrosion and ensure long-lasting service
- Dishwasher safe one-piece design improves durability, ease of cleaning, and keeps handle and mechanism from coming apart
- Extended handle provides a sure grip for comfortable use
- Ergonomically improved thumb tab is designed for natural hand movement to reduce operator fatigue
- Color-coded handle for no-guess size selection
- Blade extends beyond bowl to prevent sticking
- Cs Pk 12 x 1 ea



Item #	Mfg. #	Size	Handle Color	Capacity	Cs Wt
379734	47139	6	White	5⅓ oz	6.06 lb
379738	47140	8	Grey	4 oz	6.06 lb
379740	47141	10	Ivory	3¾ oz	6.06 lb
379741	47142	12	Green	2⅔ oz	6.06 lb
379742	47143	16	Dark Blue	2 oz	4.92 lb
379744	47144	20	Yellow	1⅞ oz	4.92 lb
379745	47145	24	Red	1⅝ oz	4.92 lb
379747	47146	30	Black	1 oz	4.92 lb
379748	47147	40	Orchid	¾ oz	4.92 lb

Sold in case pack or eaches.

ROUND SQUEEZE DISHERS

- Constructed entirely of 18/8 stainless steel
- Blade extends beyond bowl to prevent sticking
- For use with either left or right hand
- Cs Pk 12 x 1 ea



Item #	Mfg. #	Capacity	Cs Wt
453510	47159	Size 60, ⅝ oz	4.25 lb
453509	47161	Size 100, ⅞ oz	4.08 lb

Sold in case pack or eaches.

ICE CREAM DISHERS

- One-piece cast aluminum
- Defrosting fluid in handle releases portions effortlessly
- Handles are stamped with size and color-coded for at-a-glance serving
- Cs Pk 12 x 1 ea • Cs Wt 5.30 lb

Item #	Mfg. #	Capacity
476308	AD-12	3 oz
476309	AD-16	2½ oz
476310	AD-20	2 oz

Sold in case pack or eaches.



ICE CREAM SPADE

- Stainless steel spade • 9¼ oz
- Black plastic handle

Item #476338
Mfg. #DP-SP
Cs Pk 12 x 1 ea
Cs Wt 4.75 lb

Sold in case pack or eaches.



COLOR-CODED DISHERS

- Stainless steel bowl
- Color-coded for accurate portion control identification
- Dishwasher safe • Sure-grip handle
- Heavy-duty stainless steel spring • 1 year warranty
- Cs Pk 12 x 1 ea

Item #	Mfg. #	Size	Color	Capacity	Cs Wt
381295	78-06	6	White	4.86 oz	6.92 lb
381296	78-08	8	Grey	3.80 oz	6.92 lb
381297	78-10	10	Ivory	3.33 oz	6.92 lb
381298	78-12	12	Green	2.90 oz	6.92 lb
381299	78-16	16	Blue	2.16 oz	6.92 lb
381300	78-20	20	Yellow	1.84 oz	6.92 lb
381301	78-24	24	Red	1.56 oz	6.92 lb
381302	78-30	30	Black	1.07 oz	6.92 lb
381303	78-40	40	Orchid	.70 oz	6.92 lb

Sold in case pack or eaches.

COMMERCIAL DISHERS

- Stainless steel bowl
- Pan Rest™ a notched handle keeping it from slipping into pan
- Easy to read size molded on color-coded handle
- Dishwasher safe • 2 year warranty
- Cs Pk 12 x 1 ea



Item #	Mfg. #	Size	Color	Capacity	Cs Wt
429566	80-06	6	White	4.66 oz	6.36 lb
424398	80-08	8	Grey	3.64 oz	6.12 lb
424399	80-10	10	Ivory	3.19 oz	6.00 lb
430219	80-12	12	Green	2.78 oz	5.76 lb
424401	80-16	16	Dark Blue	2.07 oz	5.40 lb
429567	80-20	20	Yellow	1.77 oz	5.28 lb
429568	80-24	24	Red	1.49 oz	5.16 lb
424402	80-30	30	Black	1.03 oz	5.04 lb
424403	80-40	40	Orchid	.68 oz	5.16 lb

Sold in case pack or eaches.



Setting the Standard™



WEAR-EVER® EVER-SMOOTH™ FRY PANS

- Ever-Smooth™ interior surface ensures easier cooking and less interference from rivet heads which eliminates food and bacteria collection areas
- Exclusive Cool Handle® included
- Has all the standard advantages you expect from Wear-Ever® quality products, including superior cold-draw processing, 3004 aluminum, detailed finishing operations and the industry's best non-stick coatings
- Easy to clean

Item #	Mfg. #	Description	Cs Pk	Cs Wt
WearGuard® Finish				
497875	ES4008	8" dia x 1 7/8" d	6 x 1 ea	8.55 lb
Natural Finish®				
535540	E4010	10" dia x 2" d	6 x 1 ea	13.76 lb
535541	E4012	12" dia x 2 1/4" d	2 x 1 ea	8.22 lb
535542	E4014	14" dia x 2 1/2" d	2 x 1 ea	10.88 lb

Sold in case pack or eaches.

WEAR-EVER® COOL HANDLES®

- Will not burn, smoke or smolder even when placed in the oven or exposed to an open flame
- Easy to remove for cleaning
- Three sizes to fit most industry fry, sauté and sauce pots
- Oven safe to 600°F intermittently
- Cs Pk 12 x 1 ea



Setting the Standard™



Item #	Mfg. #	Description	Cs Wt
379537	3011	4" long	0.90 lb
Fits 7" Fry Pans, 1 1/2 qt Professional Standard Strength Sauce Pans			
379536	3010	4 1/2" long	1.36 lb
Fits 8" & 10" Fry Pans, 2 3/4 to 10 qt Professional Standard Strength Sauce Pans, 1 & 2 qt Premier Super Strength Sauté Pans			
379531	3009	6 1/2" long	1.80 lb
Fits 12" & 14" Fry Pans, 3 to 10 qt Professional Standard Strength Sauce and Sauté Pans, All Premier Super Strength Sauce Pans			

Sold in case pack or eaches.

ARKADIA™ FRY PANS

- Constructed of 3000 series aluminum with riveted handles
- Non-stick
- Cs Pk 6 x 1 ea



Setting the Standard™



Item #	Mfg. #	Top Dia*	Cs Wt
429166	N7007	7" dia	6.72 lb
429170	N7008	8" dia	8.26 lb
429171	N7010	10" dia	13.30 lb
429172	N7012	12" dia	19.82 lb
429178	N7014	14" dia	27.04 lb

**Inside dia Sold in case pack or eaches.*

WEAR-EVER® FRY PANS

- Heavy-duty impact-resistant 3004 aluminum
- EverTite™ Riveting System provides for lifetime use without loose rivets
- Ideal for heavy-duty frying
- Exclusive Cool Handle® included



Setting the Standard™



CeramiGuard® II Finish

- CeramiGuard® II is a coating system that offers both superior durability and release qualities, even in high-heat applications – better withstands the abuse of metal utensils

Item #	Mfg. #	Top Dia*	Cs Pk	Cs Wt
379500	Z4007	7"	6 x 1 ea	6.05 lb
379502	Z4008	8"	6 x 1 ea	8.60 lb
535553	Z4010	10"	6 x 1 ea	13.80 lb
535554	Z4012	12"	2 x 1 ea	8.40 lb
535555	Z4014	14"	2 x 1 ea	10.76 lb

**Inside dia Sold in case pack or eaches.*



With Wearguard® Interior

- Ideal for frying, sauteing or searing

Item #	Mfg. #	Top Dia*	Cs Pk	Cs Wt
379495	S4007	7"	6 x 1 ea	6.08 lb
379497	S4008	8"	6 x 1 ea	8.55 lb
535550	S4010	10"	6 x 1 ea	13.75 lb
535551	S4012	12"	2 x 1 ea	8.25 lb
535552	S4014	14"	2 x 1 ea	10.80 lb

**Inside dia Sold in case pack or eaches.*



Setting the Standard™

Natural Finish

- Ideal for frying and browning

Item #	Mfg. #	Top Dia*	Cs Pk	Cs Wt
379491	4007	7"	6 x 1 ea	6.02 lb
379494	4008	8"	6 x 1 ea	8.60 lb
535537	4010	10"	6 x 1 ea	13.28 lb
535538	4012	12"	2 x 1 ea	8.35 lb
535539	4014	14"	2 x 1 ea	10.95 lb

**Inside dia Sold in case pack or eaches.*



WEAR-EVER® FRY PANS

With SteelCoat® Interior

- Body is manufactured from heavy-duty impact-resistant 3004 aluminum
- Triple-layer coating provides superior food release for greater cooking efficiency
- TriVent® handle designed for comfort and durability
- Handle is oven safe to 450°F (232°C)
- EverTite™ Riveting System offers a lifetime warranty against loose rivets



Setting the Standard™



Item #	Mfg. #	Top Dia	Bottom Dia	Gauge	Cs Pk	Cs Wt
379827	67607	7"	4 3/4"	8	6 x 1 ea	6.42 lb
393091	67608	8"	5 3/4"	10	6 x 1 ea	8.34 lb
379833	67610	10"	7 5/8"	8	6 x 1 ea	13.68 lb
371052	67614	14"	10 7/8"	6	1 x 1 ea	5.52 lb

Sold in case pack or eaches.

MAJESTIC QUANTUM™ FRY PANS

- Made of 3003 aluminum alloy
- Offers great value with exceptional performance
- Non-stick with removable sleeve
- Cs Pk 6 x 1 ea



Item #	Mfg. #	Dia	Cs Wt
504827	AFP-8NS-H	8"	10.02 lb
504815	AFP-10NS-H	10"	15.43 lb
504819	AFP-12NS-H	12"	12.65 lb
504822	AFP-14NS-H	14"	29.10 lb

Sold in case pack or eaches.



Natural Finish

Excalibur™ Coating



GLADIATOR™ FRY PANS

- Heavy gauge 3003 aluminum alloy
- Strong and durable
- Spreads heat faster than other types of material
- Available in natural finish and Excalibur™ coating
- Cs Pk 6 x 1 ea



Item #	Mfg. #	Dia	Cs Wt
Natural Finish			
504825	AFP-8A	8"	10.00 lb
504814	AFP-10A	10"	15.00 lb
504818	AFP-12A	12"	19.80 lb
504821	AFP-14A	14"	24.00 lb
Excalibur™ Coating – With heat resistant silicone sleeve – to 450°F			
504828	AFP-8XC-H	8"	10.80 lb
504817	AFP-10XC-H	10"	15.78 lb
504820	AFP-12XC-H	12"	30.50 lb
504824	AFP-14XC-H	14"	27.78 lb

Sold in case pack or eaches.



Non-Stick Fry Pan

Natural Fry Pan

PREMIUM STAINLESS STEEL FRY PANS

- Premium stainless steel
- Sandwich bottoms with a aluminum core wrapped by two layers of stainless steel
- Induction ready
- Cs Pk 6 x 1 ea



Item #	Mfg. #	Dia	Cs Wt
Fry Pan – Natural Finish			
504933	SSFP-9	9½"	18.18 lb
Fry Pans – Non-stick			
504932	SSFP-8NS	8"	13.38 lb
504934	SSFP-9NS	9½"	18.18 lb
504930	SSFP-11NS	11"	25.20 lb

Sold in case pack or eaches.



CAST IRON SKILLETS

- Non-rust black coating

Item #	Mfg. #	Dia	Cs Pk	Cs Wt
504900	RSK-6	6½"	12 x 1 ea	29.80 lb
504898	RSK-10	10"	6 x 1 ea	32.20 lb
504899	RSK-12	12"	4 x 1 ea	29.54 lb

Sold in case pack or eaches.



Setting the Standard



WEAR-EVER® EGG POACHER

- Designed for medium to heavy use
- The classic 8" natural finish fry pan comes with the exclusive Cool Handle®
- Quick-release cup surfaces with non-stick coating increase efficiency
- Egg poacher set includes pan, poacher insert, cups and cover
- Replacement cups and covers available

Item #	Mfg. #	Description	Cs Pk	Cs Wt
370677	56507	4 Cup Egg Poacher Set	1 x 1 ea	2.68 lb
368875	566445	Egg Poacher Cup, 3" TD	1 x 1 ea	0.04 lb

Sold in case pack or eaches.



EVERY WARE. EVERY DAY.



FOUR EGG RING

- Chrome plated frame, non-stick egg rings
- Black cool-to-touch textured handle
- Cooks four eggs at a time
- 6½" x 10" frame
- Each egg ring is 4" dia x ⅝" high

Item #476697

Mfg. #1240
Cs Pk 2 x 1 ea
Cs Wt 2.80 lb

Sold in case pack or eaches.



OPTIO™ COOKWARE

- High quality stainless steel construction will not pit or discolor or carry flavors. Brushed stainless steel surface distributes heat quickly
- Aluminum-clad bottom provides quick and even distribution of heat
- The bottom is protected by a thin wafer of stainless steel to prevent denting and scratching
- Large radius corners minimize food waste and permit easy cleaning
- Dome cover retains moisture while cooking – included with sauce pan and stock pots

Item #	Mfg. #	Description	Cs Pk	Cs Wt
Sauce Pan				
460051	3803	4 quart	6 x 1 ea	22.32 lb
Stock Pots				
460065	3503	11 quart	2 x 1 ea	13.65 lb
460066	3504	18 quart	2 x 1 ea	18.54 lb
460067	3506	27 quart	1 x 1 ea	20.22 lb
460068	3509	38 quart	1 x 1 ea	17.62 lb
Cover				
460070	3908C	Fits 460051	6 x 1 ea	4.30 lb
460071	3910C	Fits 460065	6 x 1 ea	6.78 lb
460072	3911C	Fits 460066	6 x 1 ea	9.96 lb
460074	3914C	Fits 460068	6 x 1 ea	16.25 lb

Sold in case pack or eaches.

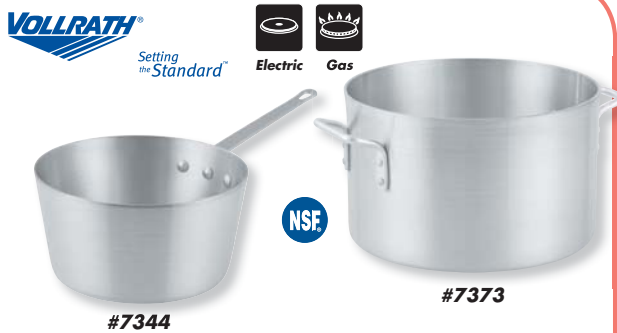

ARKADIA™ SAUCE PANS & POTS

- Constructed of 3000 series aluminum with riveted handles

Item #	Mfg. #	Description	Cs Pk	Cs Wt	Cover #
Sauce Pans					
429182	7341	1½ quart	12 x 1 ea	16.62 lb	537529
429183	7342	2¾ quart	12 x 1 ea	20.88 lb	537531
429185	7344	4½ quart	12 x 1 ea	28.74 lb	537532
429186	7345	5½ quart	12 x 1 ea	31.52 lb	537535
429187	7347	7 quart	6 x 1 ea	21.10 lb	537536
429188	7348	8½ quart	6 x 1 ea	22.80 lb	537537
429196	7350∞	10 quart	6 x 1 ea	25.42 lb	537538
Sauce Pots					
429221	7373	14 quart	1 x 1 ea	5.85 lb	429218
429223	7374	20 quart	1 x 1 ea	6.34 lb	-
429224	7375	26 quart	1 x 1 ea	7.65 lb	537539

∞ Assist Loop Handle Sold in case pack or eaches.

ARKADIA™ STOCK POTS & COVERS

- Constructed of 3000 series aluminum with riveted handles
- Ideal for preparing stocks, soups and liquids
- Covers sold separately



Item #	Mfg. #	Description	Cs Pk	Cs Wt
429199	7302	10 quart	1 x 1 ea	4.04 lb
429201	7303	12 quart	1 x 1 ea	4.38 lb
429202	7304	16 quart	1 x 1 ea	5.32 lb
429203	7305	20 quart	1 x 1 ea	6.35 lb
429206	7306	24 quart	1 x 1 ea	6.50 lb
429207	7308	32 quart	1 x 1 ea	7.40 lb

Covers

429212	7389	Fits 10/12/16 quarts	6 x 1 ea	4.78 lb
429218	7393	Fits 20/24 quarts	6 x 1 ea	4.90 lb

Sold in case pack or eaches.

ARKADIA™ COVERS

- Cs Pk 6 x 1 ea



Item #	Mfg. #	Description	Cs Wt
537529	7341C	Fits 1½ quart sauce pan	2.75 lb
537531	7342C	Fits 2¾ quart sauce pan	3.64 lb
537532	7344C	Fits 4½ quart sauce pan	5.00 lb
537535	7345C	Fits 5½ quart sauce pan	4.05 lb
537536	7347C	Fits 7 quart sauce pan	6.30 lb
537537	7348C	Fits 8½ quart sauce pan	6.62 lb
537538	7350C	Fits 10 quart sauce pan	7.86 lb
429217	7392	Fits 10 quart sauce pot	5.30 lb
429212	7389	Fits 10, 12, 16 quart stock pot and 8½ qt sauce pot	4.25 lb
429218	7393	Fits 20, 24 quart stock pot and 14 qt sauce pot	4.90 lb
537539	7351C	Fits 26, 32, 40 qt pot & 15 qt brazier	7.65 lb

Sold in case pack or eaches.

WEAR-EVER® ALUMINUM DOUBLE BOILER SET

- Solid welded aluminum handles for durability and easy interior cleaning
- Eliminates the need for constant stirring
- Complete with pot, inset and cover
- Capacity: 11 quart inset, 12 quart pot

Item #379835
Mfg. #67711
Cs Pk 1 x 1 ea
Cs Wt 7.64 lb
Sold in case pack only.





STAINLESS STEEL DOUBLE BOILER SETS

- 18/8 stainless steel
- Ideal for delicate food preparation, reheating, preheating and moisture-free cooking
- Solid welded stainless steel loop handles for durability and easy cleaning
- Rounded corners on inset pan for easy mixing
- Feature conductive bottoms that distribute heat evenly
- Complete set includes inset, pot and cover
- Will not color delicate foods
- Inset capacity 11 qt; pot capacity 11 1/2 qt
- Cs Pk 1 x 1 ea

Item #388609
Mfg. #77110
Cs Pk 1 x 1 ea
Cs Wt 8.36 lb

WEAR-EVER® TAPERED SAUCE PANS



- Natural finish interior
- Versatile tool for stirring, beating or making gravies, sauces and cereals
- Exclusive Cool Handle® included
- EverTite™ Riveting System offers a lifetime warranty against loose rivets
- 11 gauge • Cs Pk 6 x 1 ea

Item #	Mfg. #	Qts	Top Dia*	Cs Wt	Cover #
379506	434112	1 1/2	6"	7.16 lb	379517
379508	434212	2 1/4	7 3/4"	10.65 lb	515251
379510	434312	3 3/4	8 3/4"	13.70 lb	379521
379511	434412	4 1/2	9 1/2"	14.35 lb	379523
379513	434512	5 1/2	9 7/8"	15.80 lb	379525
379514	4347	7	10 5/8"	19.54 lb	379527
379515	434812	8 1/2	11 3/8"	21.60 lb	379528
379516	4350	10	12 1/8"	27.10 lb	379530

* Inside dia Sold in case pack or eaches.

WEAR-EVER® ROLLED EDGE SAUCE POTS



- All with sanitary, open bead and spot-welded loop handles
- Extra dent-resistant 3004 aluminum alloy
- Uniform thickness provides even cooking for years of excellent service
- Rolled edges maintain strength
- Cs Pk 2 x 1 ea

Item #	Mfg. #	Description	ID	Cs Wt	Cover #
379553	4332	14 quart	12"	10.26 lb	415384
379554	4333	20 quart	13"	12.45 lb	535725

Sold in case pack or eaches.



WEAR-EVER® FLAT COVERS FOR ALUMINUM COOKWARE

- 14 gauge 3004 aluminum
- Welded Torogard™ dipped handle – stays cool to the touch and heat resistant up to 180°F (82°C)
- Easy grasp handle design for safety and hanging convenience
- Coated handle is equipped with Agion® antimicrobial protection
- Flat covers: height with handle: 1 5/8" (4.1 cm)
- Cs Pk 1 x 1 ea

Item #	Mfg. #	Outside Dia	Inside Dia	Fits/pans	Cs Wt
457389	67312	8 5/16"	7 7/8"	8"	0.65 lb
537551	67315	10 1/2"	9 7/8"	10"	1.02 lb
485445	67509	10 3/4"	10 1/8"	10"-11"	0.86 lb
415384	67521	12 3/4"	12 1/8"	11"-11 1/2"	1.30 lb
535725	67533	13 3/16"	13 1/8"	13"	1.61 lb
428257	67541	14 7/8"	14 1/16"	14"	1.73 lb
448589	67561	17 1/8"	16 1/4"	16"	2.23 lb
402332	67581	18 7/8"	18 1/16"	18"	2.64 lb
445365	67691	20 7/8"	20 3/16"	20"	3.30 lb

Sold in case pack or eaches.

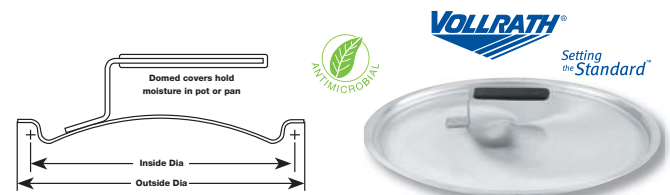

WEAR-EVER® DOME COVERS FOR ALUMINUM COOKWARE

- 14 gauge 3004 aluminum
- Welded Torogard® dipped handle – stays cool to the touch and heat resistant up to 180° (82°C)
- Easy grasp handle design for safety and hanging convenience
- Coated handle is equipped with Agion® antimicrobial protection®
- Deep satin finish • Cs Pk 1 x 1 ea

Item #	Mfg. #	Fits	Outside Dia (A)	Inside Dia (B)	Cs Wt
537540	67411	6" Pans	6 5/8"	5 7/8"	0.42 lb
515251	67412	7-8" Pans	8 3/8"	7 1/2"	0.62 lb
537541	67413	8-9" Pans	9 3/8"	8 1/2"	0.76 lb
537543	67424	9-10" Pans	10"	8 3/4"	0.80 lb
515249	67409	10" Pans	10 3/4"	9 3/4"	0.94 lb
537546	67417	10 1/2" Pans	11 3/8"	10 1/2"	1.00 lb
537549	67418	11 1/4" Pans	12 1/8"	11 1/4"	1.22 lb
379530	67020	12.2" Pans	12 3/8"	11 3/4"	1.24 lb

Sold in case pack or eaches.



VOLLRATH®
Setting the Standard™



WEAR-EVER® CLASSIC™ ALUMINUM STOCK POTS

- Standard gauge impact-resistant, energy-efficient 3004 aluminum
- Double-thick, beadless rims are easier to clean and remain round for a better cover fit, double-thick bottoms help resist denting
- Solid welded handles for durability
- Cs Pk 1 x 1 ea

Item #	Mfg. #	Capacity	Inside Dia	Cs Wt
368325	67512	12 quart	10"	4.15 lb
371054	67520	20 quart	12"	6.45 lb
371030	67524	24 quart	12"	7.00 lb
370984	67540	40 quart	14"	8.90 lb

FLAT COVERS

- 3004 aluminum
- Welded Toroguard™ dipped handle stays cool to the touch

Item #	Mfg. #	Dia	Cs Wt	Fits
485445	67509	10¾"	.86 lb	368325
415384	67521	12¾"	1.30 lb	371054, 371030
428257	67541	14¾"	1.73 lb	370984



VOLLRATH®
Setting the Standard™

WEAR-EVER® CLASSIC SELECT® DEEP SAUCE PAN WITH TRADITIONAL HANDLE

- Double-thick top edge and bottom for maximum wear
- Ideal for making sauces, soups and for simmering and boiling foods in liquids
- The best cooking sauce pan for heavy use
- 8" inside dia
- 4½ quart capacity
- Uses cover #457389

Item #398317

Mfg. #4108

Cs Pk 2 x 1 ea

Cs Wt 7.80 lb

Sold in case pack or eaches.



USE AND CARE OF ALUMINUM

Don't let acidic or salty foods remain in aluminum cookware for long periods of time – it can cause pitting and discoloration. Use cooking tools made of wood, plastic or smooth-edged metal. Prolong the original shape of your aluminum cookware by allowing it to cool before washing or soaking – this will help prevent warping. Wash and dry after each use to preserve appearance.



VOLLRATH®
Setting the Standard™

WEAR-EVER® CLASSIC™ ROLLED EDGE STOCK POTS

- Extra dent-resistant 3004 aluminum alloy
- Spot-welded handles prevent leakage
- Rolled edges maintain strength
- Easy to clean

Item #	Mfg. #	Capacity	Inside Dia	Cs Pk	Cs Wt	Cover #
379540	4303	12 quart	10"	2 x 1 ea	9.14 lb	379544
379541	4305	20 quart	12"	2 x 1 ea	12.70 lb	379547
368855	4306	24 quart	12"	1 x 1 ea	7.25 lb	379547
370895	430712	30 quart	13"	1 x 1 ea	8.95 lb	379549
368872	4310	40 quart	14"	1 x 1 ea	10.50 lb	379550
370620	4315	60 quart	16"	1 x 1 ea	13.38 lb	379550

Sold in case pack or eaches



VOLLRATH®
Setting the Standard™

WEAR-EVER® CLASSIC SELECT® BRAZIER

- Heavy duty aluminum braziers
- Wide heating surface
- Solid welded aluminum handles for durability and easy interior cleaning
- Cs Pk 1 x 1 ea

Item #	Mfg. #	Description	Inside Dia	Cs Wt	Cover #
472042	68224	24 quart	18"	12.90 lb	402332
445345	67228	28 quart	20"	14.64 lb	445365

PREMIUM STAINLESS STEEL SAUCE PANS WITH COVER

- Sandwich bottoms with an aluminum core wrapped by two layers of stainless steel
- Induction ready • Cs Pk 6 x 1 ea



Item #	Mfg. #	Description	Cs Wt
504936	SSSP-2	2 quart	17.40 lb
504938	SSSP-3	3½ quart	24.40 lb
504939	SSSP-4	4½ quart	26.58 lb



WIN-WARE ALUMINUM SAUCE POTS & COVERS

- Reinforced rim
- Minimum 3/16" thickness
- Standard weight, heavy aluminum
- Covers sold separately

Item #	Mfg. #	Description	Cs Pk	Cs Wt
Sauce Pots				
504985	ASSP-08	8 quart	1 x 1 ea	4.40 lb
504986	ASSP-14	14 quart	1 x 1 ea	7.20 lb
504987	ASSP-20	20 quart	1 x 1 ea	8.00 lb
Covers				
504854	ASSP-08C	Fits 8 quart	6 x 1 ea	4.99 lb
504856	ASSP-14C	Fits 14 quart	6 x 1 ea	7.20 lb
504857	ASSP-20C	Fits 20 quart	6 x 1 ea	9.40 lb

Sold in case pack or eaches.

WIN-WARE ALUMINUM STOCK POTS & COVERS

- Reinforced rim • Minimum 3/16" thickness
- Standard heavy weight aluminum
- Covers sold separately



Item #	Mfg. #	Description	Cs Pk	Cs Wt
Stock Pots				
504966	ALST-20	20 quart	1 x 1 ea	6.80 lb
504967	ALST-24	24 quart	1 x 1 ea	7.00 lb
504968	ALST-32	32 quart	1 x 1 ea	9.00 lb
504969	ALST-40	40 quart	1 x 1 ea	10.00 lb
504970	ALST-50	50 quart	1 x 1 ea	12.40 lb
504972	ALST-60	60 quart	1 x 1 ea	15.00 lb
504973	ALST-80	80 quart	1 x 1 ea	17.60 lb
504965	ALST-100	100 quart	1 x 1 ea	19.20 lb
Covers				
504830	ALPC-20	Fits 20 quart	6 x 1 ea	7.00 lb
504831	ALPC-24	Fits 24 quart	6 x 1 ea	8.40 lb
504832	ALPC-32	Fits 32 quart	6 x 1 ea	10.00 lb
504833	ALPC-40	Fits 40 quart	6 x 1 ea	10.39 lb
504835	ALPC-50	Fits 50 quart	6 x 1 ea	11.40 lb
504838	ALPC-60	Fits 60 quart	6 x 1 ea	14.20 lb
504839	ALPC-80	Fits 80 quart	6 x 1 ea	16.99 lb
504829	ALPC-100	Fits 100 quart	6 x 1 ea	18.00 lb

Sold in case pack or eaches



WIN-WARE ALUMINUM COOKWARE

- Reinforced rim
- Minimum 3.0mm thickness
- Standard weight, heavy aluminum
- Covers sold separately

Item #	Mfg. #	Description	Cs Pk	Cs Wt
Tapered Sauce Pans				
504840	ASP-1	1 quart	12 x 1 ea	14.40 lb
504844	ASP-2	2½ quart	12 x 1 ea	19.40 lb
504846	ASP-3	3¾ quart	12 x 1 ea	26.40 lb
504848	ASP-4	4¼ quart	12 x 1 ea	32.40 lb
504850	ASP-5	5 quart	12 x 1 ea	33.60 lb
504841†	ASP-10	10 quart	6 x 1 ea	22.80 lb
Covers				
504843	ASP-1C	Fits 1 quart	12 x 1 ea	4.20 lb
504845	ASP-2C	Fits 2½ quart	12 x 1 ea	5.19 lb
504847	ASP-3C	Fits 3¾ quart	12 x 1 ea	5.90 lb
506273	ASP-4C	Fits 4¼ quart	12 x 1 ea	3.48 lb
504851	ASP-5C	Fits 5 quart	12 x 1 ea	7.04 lb
504842	ASP-10C	Fits 10 quart	12 x 1 ea	9.60 lb

†With helper handle

Sold in case pack or eaches.



Braziers

- Reinforced rim
- Minimum 3/16" thickness
- Standard weight, heavy aluminum

Item #	Mfg. #	Description	Cs Pk	Cs Wt
504957	ALB-15	15 quart	1 x 1 ea	6.20 lb
504962	ALB-18	18 quart	1 x 1 ea	7.00 lb
504964	ALB-24	24 quart	1 x 1 ea	8.20 lb

PREMIUM STAINLESS STEEL STOCK POTS WITH COVER

- Sandwich bottoms with a 5 mm thick aluminum core wrapped by two layers of stainless steel
- Induction ready



Item #	Mfg. #	Description	Inside Dia	Cs Pk	Cs Wt
504944	SST-8	8 quart	9.5"	4 x 1 ea	25.60 lb
504940	SST-12	12 quart	11"	4 x 1 ea	33.60 lb
504941	SST-16	16 quart	11"	4 x 1 ea	36.80 lb
504942	SST-20	20 quart	11.8"	4 x 1 ea	47.80 lb
504943	SST-24	24 quart	13.4"	2 x 1 ea	31.00 lb

Sold in case pack or eaches.

WEAR-EVER® PASTA & VEGETABLE COOKER

- Includes 18½ qt 3004 aluminum pot and four perforated stainless steel inserts
- Inserts (3 qt/2.9 L) hold up to 3 servings of pasta
- Perfect for blanching vegetables
- Hanging clip for easy draining
- TriVent® silicone insulated handle is oven safe to 450°F (232°C)
- Pot: Welded handles for easy clean-up and durability
- Hole diameter: ¾" (0.5 cm)



Item #379838
Mfg. #68127
Cs Pk 1 x 1 ea
Cs Wt 13.65 lb
Sold in case pack only.

PASTA COOKER

- Heavy weight ¾" thick aluminum
- With 4 stainless steel insets
- 20 quart, 14" x 7"



Item #504984
Mfg. #APS-20
Cs Pk 1 x 1 ea
Cs Wt 15.00 lb



TACO RAIL

- Chrome plated
- Holds 12 - 6" taco shells

Item #476689
Mfg. #4040
Cs Pk 2 x 1 ea
Cs Wt 7.80 lb
Sold in case pack or eaches.



TAPERED BASTING COVER WITH BAKELITE KNOB

- 18 gauge aluminum
- Made in USA
- Cs Pk 12 x 1 ea



Item #	Mfg. #	Description	Cs Wt
482865	TBC-8	8" ID x 2" h	5.25 lb
482864	TBC-10	10" ID x 2" h	7.50 lb

Sold in case pack or eaches.

TACO/TOSTADA FRY BASKETS

- Black cool-to-touch PVC handles



Item #476688
Mfg. #40
Holds 8 - 6" taco shells, nickel plated
Cs Pk 8 x 1 ea
Cs Wt 31.00 lb



Item #476691
Mfg. #41
Holds 17 - 6" tostada shells, chrome plated
Cs Pk 8 x 1 ea
Cs Wt 31.00 lb
Sold in case pack or eaches.

PASTA BASKETS

- Stainless steel
- Blue cool-to-touch PVC handles



Item #476692
Mfg. #985
5¼" dia x 7" h
Cs Pk 2 x 1 ea
Cs Wt 2.83 lb
Sold in case pack or eaches.

Item #476693
Mfg. #986
6½" dia x 7" h
Cs Pk 2 x 1 ea
Cs Wt 3.75 lb

#985



#986

COOKING BASKETS

- Stainless steel



Item #476695
Mfg. #988
10½" x 3½" round
Cs Pk 2 x 1 ea
Cs Wt 5.00 lb
Sold in case pack or eaches.

Item #476694
Mfg. #987
8¼" x 5" round
Cs Pk 2 x 1 ea
Cs Wt 4.66 lb

#988



#987

TACO SALAD BASKETS

- Chrome plated • Cs Pk 4 x 1 ea

Item # 476685 Mfg. # 44060 Description Sloped basket, 8½" front to back, 8" at widest point, 5" deep at front, 1½" deep at back, 17¾" long handle Cs Wt 7.33 lb



476686 44080 Deep basket, 7½" wide at top, 4¼" wide at base 5" deep, 18" long handle 8.00 lb

Sold in case pack or eaches.

FRY BASKETS

- Nickel plated finish wire
- 1.4mm heavy wire frame
- Reinforced base
- Plastic coated handle
- Fits all brands of deep fryers



#FB-135PH

Item #476343
Mfg. #FB-126PH
12⅞"l x 6½"w x 5⅞"d
Cs Pk 6 x 1 ea
Cs Wt 20.00 lb

Sold in case pack or eaches.

Item #476345
Mfg. #FB-135PH
13¼"l x 5½"w x 5⅞"d
Cs Pk 6 x 1 ea
Cs Wt 17.00 lb

Sold in case pack or eaches.

CULINARY BASKETS

- Nickel plated steel wire
- 10" dia top



#CUB-10C

Fine Mesh
Item #476282
Mfg. #CUB-10S
Cs Pk 6 x 1 ea
Cs Wt 8.50 lb

Sold in case pack or eaches.

Coarse Mesh
Item #476283
Mfg. #CUB-10C
Cs Pk 6 x 1 ea
Cs Wt 8.50 lb

Sold in case pack or eaches.



SILPAT FITTED NON-STICK BAKING MATS

- Made of silicone & fiberglass
- Non-stick surface allows baked goods to slide off the mat after baking without the need for a spatula
- Cs Pk 3 x 1 ea

Item #	Mfg. #	Description	Cs Wt
Full Size			
482830	SPF4262	18" x 26"	1.50 lb
Half Size			
482832	SPH2295	11⅞" x 16½"	1.13 lb

Sold in case pack or eaches.

ALUMINUM SHEET PANS

- Closed bead with galvanized wire for rust resistance and reinforcement
- 3003 aluminum



Item #	Mfg. #	Description	Cs Pk	Cs Wt
Full Size - 18" x 26"				
504980	ALXP-1826	18 gauge	1 x 1 dz	36.00 lb
504982	ALXP-2618H	16 gauge	1 x 1 dz	38.00 lb
Half Size - 13" x 18"				
507097	ALXP-1318		1 x 1 dz	21.60 lb
Quarter Size - 9½" x 13"				
504975	ALXP-1013		1 x 2 dz	21.60 lb

Sold in case pack only.

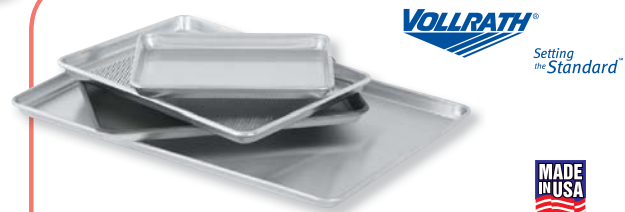

WEAR-EVER® HEAVY-DUTY SHEET PANS

- Impact-resistant 3000 series aluminum
- Tapered design for easy stacking
- Sizes to fit standard baker's racks
- Closed bead includes galvanized non-rusting rod for reinforcements
- Natural finish
- Cs Pk 1 x 1 dz

Item #	Mfg. #	Description	Cs Wt
Full Size - 18" x 26" x 1"			
369607	9001	Solid, 16 gauge	46.90 lb
369599	9002	Solid, 18 gauge	37.42 lb
378485	9002P	Perforated, 18 gauge	38.00 lb
381404	9003	Solid, Economy, 19 gauge	37.90 lb
Half Size - 18" x 13" x 1"			
369600	5303	Solid, 18 gauge	23.90 lb
381405	9303	Solid, Economy, 19 gauge	19.62 lb
Quarter Size - 9½" x 13" x 1"			
378484	5220	Solid, 16 gauge	10.44 lb

Sold in case pack only.

BUN/SHEET PANS

- Economy wight, aluminum
- Reinforced wire rim holds pan shape
- 1" edge
- Cs Pk 1 x 1 dz



Item #	Mfg. #	Description	Cs Wt
Full Size Bun			
476451	ABNP-100	18" x 26"	40.00 lb
Half Size Bun			
476452	ABNP-50	13" x 18"	26.00 lb

Sold in case pack only.



#4482

#448212

#68361

#68362



WEAR-EVER® ALUMINUM ROASTERS

- Heavy-gauge 3004 aluminum with beadless rims
- When used as double roasters, section fits snugly to seal in steam
- Top or bottom sections may be used individually for open pan roasting
- Heats evenly and efficiently – recommend reducing oven temperature by 25°F (-3.9°C) to reduce energy costs
- Loop handles for durability

Item #	Mfg. #	Description	Cs Pk	Cs Wt
Tops – with Straps				
379569	4482	20 ¹ / ₈ " x 16 ¹ / ₈ " x 4 ¹ / ₂ "	2 x 1 ea	16.15 lb
535288	68361	24" x 18" x 4 ³ / ₄ "	2 x 1 ea	20.56 lb
Bottom – with Straps				
379571	448212	20 ¹ / ₈ " x 16 ¹ / ₈ " x 4 ¹ / ₂ "	2 x 1 ea	16.75 lb
538142	68362	24" x 18" x 4 ³ / ₄ "	2 x 1 ea	20.84 lb

Sold in case pack or eaches.

WEAR-EVER® HEAVY-DUTY ALUMINUM ROASTER

- Extra dent-resistances 3004 aluminum
- Easy-to-grab loop handle on all four sides of pan
- Traditional standard with the military
- Cover can be used as a griddle (not included)
- 20¹/₈" x 17³/₈" x 7"

MADE IN USA
Shown with cover (sold separately)



Item #449418

Mfg. #68391

Cs Pk 1 x 1 ea

Cs Wt 17.45 lb

Sold in case pack or eaches.



HINGED INSET COVERS

- Mirror-finished stainless steel
- Welded clips on stationary side hold cover in place
- Kool-Touch® phenolic knob handle
- Easy one-hand operation
- Slot for ladles or spoons when cover is closed
- Cs Pk 6 x 1 ea

Item #	Mfg. #	Description	Cs Wt
425216	47488	7 ¹ / ₄ quart	5.49 lb
425217	47490	11 quart	7.39 lb

Sold in case pack or eaches.



SPILLAGE PANS

- Accepts standard size pans
- Can use with adaptor plates or insets
- Suitable for bulk storage
- Cs Pk 1 x 1 ea

Item #	Mfg. #	Description	Cs Wt
370914	99765	Stainless Steel	5.40 lb
368294	99785	Aluminum	3.85 lb



WEAR-EVER® BAKE & ROAST PANS



- Extra dent resistant, heavy-duty impact-resistant 3004 aluminum
- Solid welded aluminum handles for durability and easy cleaning
- Standard sizes for most commercial applications
- Solid welded loop handles
- Easy to clean natural finish
- The superb quality of Wear-Ever® bake pans is known in every commercial kitchen

Item #	Mfg. #	Description	Cs Pk	Cs Wt
Satin Finish – Tapered Sides, Handled				
379556	4412	9 ³ / ₄ " x 13 ¹ / ₄ " x 2 ¹ / ₄ ", 16 ga	6 x 1 ea	7.98 lb
Satin Finish – Tapered Sides, No Handles				
535297	68357†	25 ³ / ₄ " x 17 ³ / ₄ " x 2 ¹ / ₄ ", 12 ga	6 x 1 ea	28.98 lb
Polished/Natural Finish – Straight Sides, Handled				
535301	68369	18 ¹ / ₈ " x 12 ¹ / ₈ " x 2 ¹ / ₈ ", 14 ga	3 x 1 ea	7.95 lb

Sold in case pack or eaches.
†NSF Certified - Without Handles



KITCHEN



STAINLESS STEEL INSETS & COVERS



- Satin-finished 300 series stainless steel insets
- Insets nest together for compact storage when not in use
- 6" (15.2cm) depth under the shoulder
- Solid or slotted flat covers reduce heat loss
- Sharp radius between sleeves rests securely in opening without tipping
- Short insets deliver portions that offer better food quality and reduced food waste
- Cs Pk 6 x 1 ea

Item #	Mfg. #	Description	Cs Wt
Insets			
379880	78154	2 ¹ / ₂ quart	5.70 lb
379883	78164	4 ¹ / ₈ quart	7.20 lb
379886	78184	7 ¹ / ₄ quart	9.78 lb
379892	78204	11 quart	13.02 lb
Covers			
379876	78150†	Slotted, fits 2 ¹ / ₂ quart	1.56 lb
387861	78160†	Slotted, fits 4 ¹ / ₈ quart	2.28 lb
379885	78180†	Slotted, fits 7 ¹ / ₄ quart	3.66 lb
379890	78200†	Slotted, fits 11 quart	5.04 lb

† Not NSF listed *Sold in case pack or eaches.*

SUPERPAN 3® STAINLESS STEEL PANS

- Sturdy 22 gauge (.8 mm), 300 series stainless steel construction
- Angled ramp – pull-and-lift pans with ease
- Anti-jam stacking lugs – separate and dry pans without any hassle
- Reinforced spouted-shape corners add strength
- Integral frame enhances food presentation
- Flattened pan edges – prevent bending and provide a wider grasp when removing
- EN631-1 Compliant – for worldwide use
- Cs Pk 6 x 1 ea



Item #	Mfg. #	Description	Cs Wt
Full Size – 20⁷/₈" x 12¹³/₁₆"			
432415	90022	2 ¹ / ₂ " deep, 9 quart	17.08 lb
432416	90023	2 ¹ / ₂ " deep, Perforated	17.00 lb
432418	90042	4" deep, 14.2 quart	20.10 lb
432417	90043	4" deep, Perforated	19.90 lb
432419	90062	6" deep, 20.1 quart	24.00 lb
432421	93100	Flat Solid Cover	14.80 lb
432422	94100	Flat Slotted Cover	14.85 lb
One-Half Size – 12³/₁₆" x 10⁷/₁₆"			
432423	90222	2 ¹ / ₂ " deep, 4 quart	9.26 lb
432424	90242	4" deep, 6.3 quart	11.10 lb
432425	90243	4" deep, Perforated	10.80 lb
432439	90262	6" deep, 9.4 quart	13.18 lb
432440	93200	Flat Solid Cover	7.50 lb
432441	94200	Flat Slotted Cover	7.46 lb
One-Third Size – 6¹⁵/₁₆" x 12¹³/₁₆"			
432442	90322	2 ¹ / ₂ " deep, 2.5 quart	6.85 lb
432443	90342	4" deep, 3.9 quart	8.10 lb
432446	90362	6" deep, 5.8 quart	9.92 lb
432447	93300	Flat Solid Cover	5.10 lb
432448	94300	Flat Slotted Cover	5.01 lb
One-Fourth Size – 6³/₈" x 10⁷/₁₆"			
432449	90422	2 ¹ / ₂ " deep, 1.8 quart	5.50 lb
432450	90442	4" deep, 2.7 quart	6.30 lb
432454	90462	6" deep, 4.0 quart	7.90 lb
432455	93400	Flat Solid Cover	3.84 lb
432456	94400	Flat Slotted Cover	3.80 lb
One-Sixth Size – 6¹/₁₆" x 6³/₈"			
432457	90622	2 ¹ / ₂ " deep, 1.1 quart	3.70 lb
432458	90642	4" deep, 1.7 quart	4.40 lb
432459	90662	6" deep, 2.4 quart	5.42 lb
432460	93600	Flat Solid Cover	2.65 lb
432461	94600	Flat Slotted Cover	2.60 lb
One-Ninth Size – 6¹/₁₆" x 4¹/₄"			
432462	90942	4" deep, 0.9 quart	3.40 lb

Sold in case pack or eaches.



Setting the Standard

STAINLESS ADAPTOR PLATE

- Two 8³/₈" inset holes hold 7¹/₄ quart insets (sold separately)
- 300 series stainless steel construction
- Fits standard steam table openings to hold insets and bain maries
- Made in USA

Item #425214

Mfg. #19192
Cs Pk 4 x 1 ea
Cs Wt 7.84 lb



Sold in case pack or eaches.



KITCHEN

GUIDE TO STEAM TABLE PANS

Complete flexibility for steam table service is available through a wide range of sectional pans which includes Full Size, 2/3 Size, 1/2 Size, 1/2 Long Size, 1/3 Size, 1/4 Size, 1/6 Size, and 1/9 Size. All pans are made to fit both 19⁷/₈" x 11⁷/₈" or 20" x 12" openings. This extensive line makes countless combinations to meet specific individual requirements. Pans are seamless with smooth, rounded corners for easy cleaning and quick serving.

Size	Width (L to R)	Length (F to B)	Size	Width (L to R)	Length (F to B)
Full	12 ³ / ₄ "	20 ³ / ₄ "	1/3	12 ³ / ₄ "	6 ⁷ / ₈ "
1/2	12 ³ / ₄ "	10 ³ / ₈ "	1/6	6 ¹ / ₄ "	6 ⁷ / ₈ "
1/4	6 ³ / ₈ "	10 ³ / ₈ "	1/9	4 ¹ / ₄ "	6 ⁷ / ₈ "
2/3	12 ³ / ₄ "	13 ¹ / ₃ "			

Standard depths are 2¹/₂", 4" and 6". Adapter bars in 12" or 20" lengths are needed when your arrangement has unsupported corners. A variety of lid sizes and types are sold.

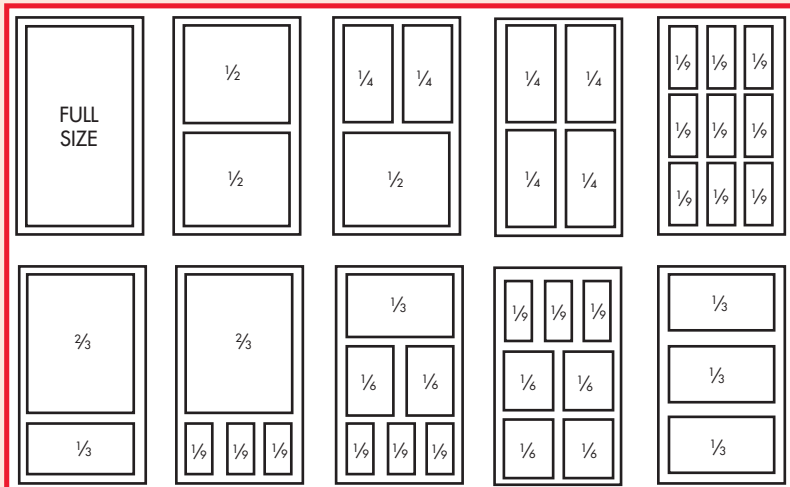



SUPER PAN II®

- Made in the U.S.A. of 22 gauge, type 300 series stainless steel
- The Reinforcer® corner withstands more impact than ordinary pans
- Anti-jamming design – stacking lugs prevent pans from sticking together
- Coved interior corners make scooping easier



Item #	Mfg. #	Description	Cs Pk	Cs Wt
Full Size – 20¾" x 12¾"				
379629	30022	2½" deep, 8.3 quart	6 x 1 ea	18.46 lb
379630	30023	2½" deep, Perforated	6 x 1 ea	16.68 lb
379631	30042	4" deep, 14.0 quart	6 x 1 ea	22.62 lb
379632	30043	4" deep, Perforated	6 x 1 ea	19.20 lb
379633	30062	6" deep, 21.0 quart	6 x 1 ea	26.16 lb
379875	77250	Flat Solid Cover	6 x 1 ea	15.18 lb
442303	75210	Flat Slotted Cover	6 x 1 ea	15.18 lb
368235	77200	Solid Dome Cover	1 x 1 ea	3.39 lb
368315	77400	Hinged Dome Cover	1 x 1 ea	4.44 lb
One-Half Size – 10¾" x 12¾"				
379634	30222	2½" deep, 4.3 quart	6 x 1 ea	10.74 lb
379635	30242	4" deep, 6.7 quart	6 x 1 ea	12.14 lb
379636	30243	4" deep, Perforated	6 x 1 ea	11.70 lb
379637	30262	6" deep, 10.0 quart	6 x 1 ea	14.52 lb
379851	75120	Flat Solid Cover	6 x 1 ea	6.30 lb
379865	75220	Flat Slotted Cover	6 x 1 ea	6.18 lb
One-Half Size Long – 20¾" x 6⅞"				
379645	30542	4" deep, 5.7 quart	3 x 1 ea	6.66 lb

Item #	Mfg. #	Description	Cs Pk	Cs Wt
One-Third Size – 6⅞" x 12¾"				
379638	30322	2½" deep, 2.6 quart	6 x 1 ea	7.80 lb
379640	30342	4" deep, 4.1 quart	6 x 1 ea	9.30 lb
379641	30362	6" deep, 6.1 quart	6 x 1 ea	11.22 lb
379853	75130	Flat Solid Cover	6 x 1 ea	4.14 lb
379867	75230	Flat Slotted Cover	6 x 1 ea	4.14 lb
One-Fourth Size – 6⅞" x 10¾"				
379642	30422	2½" deep, 1.8 quart	6 x 1 ea	5.99 lb
379643	30442	4" deep, 3.0 quart	6 x 1 ea	7.26 lb
379644	30462	6" deep, 4.5 quart	6 x 1 ea	8.76 lb
379857	75140	Flat Solid Cover	6 x 1 ea	3.18 lb
379869	75240	Flat Slotted Cover	6 x 1 ea	3.24 lb
One-Sixth Size – 6⅞" x 6¼"				
379646	30622	2½" deep, 1.2 quart	6 x 1 ea	4.26 lb
379647	30642	4" deep, 1.8 quart	6 x 1 ea	5.28 lb
379648	30662	6" deep, 2.7 quart	6 x 1 ea	6.48 lb
379859	75160	Flat Solid Cover	6 x 1 ea	2.40 lb
379873	75260	Flat Slotted Cover	6 x 1 ea	2.22 lb
One-Ninth Size – 6⅞" x 4¼"				
379649	30942	4" deep, 1.1 quart	6 x 1 ea	3.90 lb

Sold in case pack or eaches.

KITCHEN

SUPER PAN II® FALSE BOTTOMS



- 300 series stainless steel
- Hold foods above pan bottom for draining
- Finger holes provide easy removal from pan
- Diameter of small holes: ⅜" (9.5mm)
- Cs Pk 6 x 1 ea



Item #	Mfg. #	Description	Cs Wt
Fits Full Size Pan			
381772	20000	17¼" x 9½" x ⅛"	11.10 lb
Fits ½ Size Pan			
381771	20200	7½" x 10½" x ⅞"	5.08 lb
Fits ⅓ Size Pan			
487321	20300	10⅞" x 4⅜" x ½"	2.36 lb

Sold in case pack or eaches.

SUPER PAN II® WIRE GRATE

- Fits ½ size steam table pan
- Heavy-duty 300 series stainless steel wire construction
- Ample finger room in grate corner for easy removal from pan
- Use for cooling, icing, display, or drying rack
- 11⅞" x 8⅜" x ¼"

Item #484633

Mfg. #20228
Cs Pk 12 x 1 ea
Cs Wt 14.83 lb
Sold in case pack or eaches.



ADAPTOR BARS

- Mirror-finished 300 series stainless steel
- Fits standard opening for combinations of smaller fractional pans
- Cs Pk 12 x 1 ea

#75012



Item #	Mfg. #	Description	Cs Wt
379845	75012	12½" x 1" x ¼"	2.16 lb
379849	75020	20⅜" x 1" x ¼"	3.60 lb

Sold in case pack or eaches.

#75020



STEAM TABLE PANS AND COVERS

- Step up to anti-jam steam table pans
- Available in 23 and 25 gauge 18/8 stainless steel
- Reinforced corner design gives strength and allows space between pans for easy removal
- Superior fit and heating efficiency extends holding times



Item #	Mfg. #	Description	Cs Pk	Cs Wt
Pans				
482397	SPH-1002	Full Size Pan, 2½" deep	6 x 1 ea	19.90 lb
482398	SPH-1004	Full Size Pan, 4" deep	6 x 1 ea	23.61 lb
482399	SPH-1006	Full Size Pan, 6" deep	6 x 1 ea	26.21 lb
482400	SPH-114	Ninth Size Pan, 4" deep	12 x 1 ea	6.98 lb
482401	SPH-164	Sixth Size Pan, 4" deep	12 x 1 ea	11.38 lb
482402	SPH-166	Sixth Size Pan, 6" deep	12 x 1 ea	14.26 lb
482459	SPH-254	Fourth Size Pan, 4" deep	12 x 1 ea	15.80 lb
482403	SPH-332	Third Size Pan, 2½" deep	12 x 1 ea	15.59 lb
482404	SPH-334	Third Size Pan, 4" deep	12 x 1 ea	20.37 lb
482405	SPH-336	Third Size Pan, 6" deep	12 x 1 ea	22.80 lb
482406	SPH-502	Half Size Pan, 2½" deep	12 x 1 ea	19.96 lb
482407	SPH-504	Half Size Pan, 4" deep	6 x 1 ea	13.45 lb
482408	SPH-506	Half Size Pan, 6" deep	6 x 1 ea	15.15 lb
Covers - Notched				
482409	STP-100CHC	Fits Full Size Pan	12 x 1 ea	25.20 lb
482410	STP-16CHC	Fits Sixth Size Pan	12 x 1 ea	5.20 lb
482411	STP-33CHC	Fits Third Size Pan	12 x 1 ea	9.50 lb
482413	STP-50CHC	Fits Half Size Pan	12 x 1 ea	14.70 lb

Sold in case pack or eaches.

PAN GRATES

- Heavy duty
- Chrome plated wire
- Cs Pk 12 x 1 ea

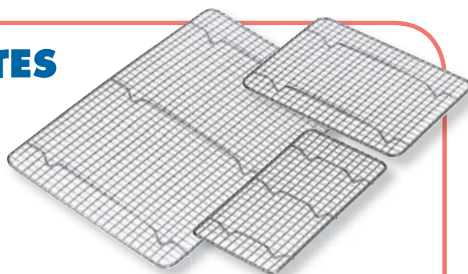

Item #	Mfg. #	Description	Cs Wt
476389	PG-1018	Full size, 10" x 18"	14.04 lb
476391	PG-810	Half size, 8½" x 10¼"	5.54 lb
476390	PG-510	Third size, 5" x 10¼"	7.44 lb

Sold in case pack or eaches.



STEAM TABLE ROLL COVER

- 18/8 stainless steel
- Bakelite handle stays cool to the touch
- Locking stainless steel, screws adjust position
- 21"l x 13¼"w x 11¼"h

Item #481092
Mfg. #STP-RC
Cs Pk 1 x 1 ea
Cs Wt 12.10 lb



VEGETABLE INSET PANS AND COVERS

- 18/8 stainless steel
- Mirrored finish exterior/satin finish interior
- Cs Pk 6 x 1 ea

Item #	Mfg. #	Description	Cs Wt
Inset Pans			
482361	IS-40	4 quart	2.64 lb
482362	IS-70	7 quart	10.00 lb
Covers			
482363	ISC-40	Fits IS-40	2.81 lb
482364	ISC-70	Fits IS-70	4.25 lb
482365	ISHC-70	Fits IS-70 (hinged)	5.72 lb

Sold in case pack or eaches.



COLANDERS FOR FOOD PANS

- Rinse drain and store-all in one pan
- Polycarbonate colander pans allow juices and moisture to drain quickly
- Cs Pk 6 x 1 ea

Item #	Mfg. #	Description	Cs Wt
459598	23CLRCW-135	Half Size, 3" deep	6.50 lb
459601	25CLRCW-135	Half Size, 5" deep	8.25 lb
459603	35CLRCW-135	Third Size, 5" deep	6.25 lb

Sold in case pack or eaches.

WORLD PANS™ & COVERS

- Store, transport and serve all in one pan
- Standard and metric graduations for easy inventory management
- Clear sidewalls – no guessing about what's inside
- Non-stick surfaces promote improved yields and easier cleaning



Camwear® Food Pans

- Virtually unbreakable polycarbonate will not crack, bend or dent.
- Wide temperature range from -40° to 210°F
- Color: Clear or Black
- Cs Pk 6 x 1 ea

Camwear®
available in clear
and black only.

CAMBRO
TRUSTED FOR GENERATIONS™



H-Pans available
in amber only.

H-Pans™

- Withstands temperatures from -40° to 375°F
- Perfect for microwave oven or steam table applications
- Great for flash freezing, cooking and reheating
- Color: Amber
- Cs Pk 6 x 1 ea



Description	Camwear® - Clear			Camwear® - Black			H-Pans™ - Amber		
	Item #	Mfg. #	Cs Wt	Item #	Mfg. #	Cs Wt	Item #	Mfg. #	Cs Wt
Full Size - 12¾" x 20½"									
Pan, 2½" deep, 8.9 quart	379847	12CW-135	10.50 lb	431257	12CW-110	10.50 lb	379855	12HP-150	12.75 lb
Pan, 4" deep, 13.7 quart	379889	14CW-135	13.50 lb	431258	14CW-110	13.50 lb	379900	14HP-150	15.50 lb
Pan, 6" deep, 20.6 quart	380067	16CW-135	17.50 lb	431259	16CW-110	17.50 lb	--	--	--
Cover, Flat	379746	10CWC-135	8.75 lb	--	--	--	--	--	--
Cover, with Handle	379763	10CWCH-135	9.00 lb	--	--	--	379777	10HPCH-150	9.50 lb
Cover, Notched with Handle	379770	10CWCHN-135	9.00 lb	--	--	--	--	--	--
Drain Shelf	431260	10CWD-135	7.25 lb	--	--	--	--	--	--
Seal Cover, White	431261	10SC-148	7.00 lb	--	--	--	--	--	--
One-Half Size - 10⅞" x 12¾" (*Long - 6⅞" x 20⅞")									
Pan, 2½" deep, 4.1 quart	380133	22CW-135	5.75 lb	431262	22CW-110	5.75 lb	380135	22HP-150	6.25 lb
Pan, 4" deep, 6.3 quart	380138	24CW-135	7.50 lb	431263	24CW-110	7.50 lb	380139	24HP-150	8.75 lb
Pan Long*, 4" deep, 5.3 quart	--	--	--	484632	24LPCW-110	8.00 lb	--	--	--
Pan, 6" deep, 9.4 quart	380141	26CW-135	10.25 lb	431265	26CW-110	10.25 lb	--	--	--
Cover, Flat	380120	20CWC-135	3.75 lb	--	--	--	--	--	--
Cover, with Handle	380123	20CWCH-135	4.25 lb	--	--	--	380129	20HPCH-150	4.75 lb
Cover, Notched with Handle	380125	20CWCHN-135	4.25 lb	--	--	--	--	--	--
Drain Shelf	431267	20CWD-135	2.50 lb	--	--	--	--	--	--
Seal Cover, White	431266	20SC-148	3.25 lb	--	--	--	--	--	--
One-Third Size - 6⅞" x 12¾"									
Pan, 2½" deep, 2.5 quart	380368	32CW-135	4.50 lb	--	--	--	--	--	--
Pan, 4" deep, 3.8 quart	380373	34CW-135	5.50 lb	431269	34CW-110	5.50 lb	380375	34HP-150	6.25 lb
Pan, 6" deep, 5.6 quart	380377	36CW-135	7.00 lb	431270	36CW-110	7.00 lb	380381	36HP-150	8.00 lb
Cover, Flat	380339	30CWC-135	3.00 lb	--	--	--	--	--	--
Cover, with Handle	380342	30CWCH-135	3.00 lb	--	--	--	380357	30HPCH-150	3.25 lb
Cover, Notched with Handle	431274	30CWCHN-135	3.00 lb	--	--	--	--	--	--
Drain Shelf	431272	30CWD-135	1.50 lb	--	--	--	--	--	--
Seal Cover, White	393083	30SC-148	2.00 lb	--	--	--	--	--	--
One-Fourth Size - 6⅞" x 10⅞"									
Pan, 2½" deep, 1.8 quart	380395	42CW-135	3.25 lb	--	--	--	--	--	--
Pan, 4" deep, 2.7 quart	380398	44CW-135	4.00 lb	--	--	--	380400	44HP-150	4.25 lb
Pan, 6" deep, 3.9 quart	380404	46CW-135	5.25 lb	--	--	--	380408	46HP-150	5.75 lb
Cover, with Handle	380384	40CWCH-135	2.25 lb	--	--	--	--	--	--
Drain Shelf	399056	40CWD-135	1.00 lb	--	--	--	--	--	--
One-Sixth Size - 6⅞" x 6⅞"									
Pan, 2½" deep, 1.1 quart	380588	62CW-135	2.00 lb	--	--	--	--	--	--
Pan, 4" deep, 1.6 quart	380591	64CW-135	2.75 lb	431276	64CW-110	2.75 lb	380592	64HP-150	3.00 lb
Pan, 6" deep, 2.4 quart	380593	66CW-135	3.75 lb	424458	66CW-110	3.75 lb	380595	66HP-150	4.00 lb
Cover, Flat	380580	60CWC-135	2.00 lb	--	--	--	--	--	--
Cover, with Handle	380581	60CWCH-135	1.75 lb	--	--	--	380586	60HPCH-150	2.00 lb
Cover, Notched with Handle	381693	60CWCHN-135	1.75 lb	--	--	--	--	--	--
Drain Shelf	431280	60CWD-135	.75 lb	--	--	--	--	--	--
Seal Cover, White	431281	60SC-148	1.00 lb	--	--	--	--	--	--
One-Ninth Size - 4⅞" x 6⅞"									
Pan, 2½" deep, 0.6 quart	380603	92CW-135	2.00 lb	--	--	--	--	--	--
Pan, 4" deep, 0.9 quart	380604	94CW-135	1.75 lb	431288	94CW-110	1.75 lb	--	--	--
Cover, Flat	380601	90CWC-135	1.00 lb	--	--	--	--	--	--
Seal Cover, White	431289	90SC-148	.75 lb	--	--	--	--	--	--

Sold in case pack or eaches.



CAMBRO
TRUSTED FOR GENERATIONS™



TRANSLUCENT FOOD PANS

- Economical for storing food as well as using on prep tables and in food bars
- For deli cases and cold service line applications
- Not to be used in oven, steam table, or microwave
- Made of polypropylene to handle a wide temperature range from -40° to 160°F (-40° to 70°C)
- High chemical resistance • Non-stick smooth interior surface
- Meets Gastronorm specifications • Cs Pk 6 x 1 ea

Item #	Mfg. #	Description	Cs	Wt
Full Size - 12¾" x 20⅞"				
423322	14PP-190	Pan, 4" deep, 13.7 quart	9.87	lb
423323	16PP-190	Pan, 6" deep, 20.6 quart	12.52	lb
423334	10PPCH-190	Cover w/ Handle	6.04	lb
Half Size - 10⅞" x 12¾"				
423325	24PP-190	Pan, 4" deep, 6.3 quart	5.34	lb
423326	26PP-190	Pan, 6" deep, 9.4 quart	7.80	lb
423335	20PPCH-190	Cover w/ Handle	2.99	lb
Third Size - 6⅞" x 12¾"				
423327	34PP-190	Pan, 4" deep, 3.8 quart	3.99	lb
423329	36PP-190	Pan, 6" deep, 5.6 quart	5.00	lb
423337	30PPCH-190	Cover w/ Handle	2.00	lb
Sixth Size - 6⅜" x 6⅞"				
423330	64PP-190	Pan, 4" deep, 1.6 quart	2.00	lb
423332	66PP-190	Pan, 6" deep, 2.4 quart	2.70	lb
423338	60PPCH-190	Cover w/ Handle	1.06	lb
Translucent Seal Covers				
Protects food quality while eliminating the expense of plastic wrap				
431290	10PPSC-190	Fits Full Size Pan	6.55	lb
431291	20PPSC-190	Fits Half Size Pan	3.38	lb
431293	40PPSC-190	Fits Fourth Size Pan	1.60	lb
431294	60PPSC-190	Fits Sixth Size Pan	1.11	lb

Sold in case pack or eaches.



Pans sold separately.

CAMBRO
TRUSTED FOR GENERATIONS™

NOTCHED FLIPLID®

- Instead of removing a lid and possibly cross-contaminating food, just flip up the lid and easily access pan contents
- Notch allows a portion scoop or spoon to be held in the pan
- Lid stays up at 94° for easy access
- Stacks with lids and pans – easily taken apart for cleaning
- Cs Pk 6 x 1 ea

Item #	Mfg. #	Description	Cs	Wt
Notched Polycarbonate - Clear				
382390	20CWLN-135	½ Pan Size	5.53	lb
382391	30CWLN-135	⅓ Pan Size	3.76	lb
382392	60CWLN-135	⅙ Pan Size	2.00	lb
Notched High Heat - Amber				
382393	20HPLN-150	½ Pan Size	5.86	lb
382402	30HPLN-150	⅓ Pan Size	4.00	lb
382403	60HPLN-150	⅙ Pan Size	2.04	lb

Sold in case pack or eaches.



Winco
The Professional Resource For The Food Service Industry

POLY-WARE™ FOOD PANS & COVERS



- Use for storage, transportation and serving display
- Clear, durable polycarbonate pans
- Break resistant – won't rust, dent or bend
- Non-stick surface for easy food release, easy cleaning
- Wide temperature range -40° to 210°F
- Dishwasher safe

Item #	Mfg. #	Description	Cs Pk	Cs	Wt
Full Size - 13" x 21"					
504904	SP7102	2½" deep	6 x 1 ea	12.80	lb
504906	SP7104	4" deep	6 x 1 ea	15.20	lb
504907	SP7106	6" deep	6 x 1 ea	20.40	lb
504903	SP7100C	Cover, Slotted	12 x 1 ea	16.75	lb
Half Size - 10½" x 12¾"					
504909	SP7202	2½" deep	12 x 1 ea	12.20	lb
504910	SP7204	4" deep	6 x 1 ea	7.45	lb
504911	SP7206	6" deep	6 x 1 ea	10.30	lb
504908	SP7200C	Cover, Slotted	12 x 1 ea	7.75	lb
Third Size - 7" x 12¾"					
504913	SP7302	2½" deep	12 x 1 ea	10.00	lb
504914	SP7304	4" deep	12 x 1 ea	12.80	lb
504915	SP7306	6" deep	6 x 1 ea	8.00	lb
504912	SP7300C	Cover, Slotted	12 x 1 ea	4.97	lb
Fourth Size - 6½" x 10½"					
504917	SP7404	4" deep	12 x 1 ea	9.80	lb
504919	SP7406	6" deep	6 x 1 ea	6.50	lb
504916	SP7400C	Cover, Slotted	12 x 1 ea	4.37	lb
Sixth Size - 6⅞" x 7"					
504921	SP7602	2½" deep	12 x 1 ea	5.60	lb
504923	SP7604	4" deep	12 x 1 ea	6.24	lb
504924	SP7606	6" deep	6 x 1 ea	4.00	lb
504920	SP7600C	Cover, Slotted	12 x 1 ea	2.97	lb
Ninth Size - 4¼" x 7"					
504928	SP7902	2½" deep	12 x 1 ea	5.04	lb
504929	SP7904	4" deep	12 x 1 ea	1.80	lb
504926	SP7900C	Cover, Slotted	12 x 1 ea	3.74	lb

Sold in case pack or eaches.

STAINLESS STEEL MIXING BOWLS

update
international

- 18/8 stainless steel
- Mirror finish
- Easy to clean
- Dishwasher safe



Item #	Mfg. #	Description	Cs Pk	Cs	Wt
482373	MB-150	1.5 quart	24 x 1 ea	7.70	lb
482374	MB-300	3 quart	24 x 1 ea	13.00	lb
482377	MB-500	5 quart	24 x 1 ea	14.00	lb
482379	MB-800	8 quart	12 x 1 ea	12.00	lb
482372	MB-1300	13 quart	12 x 1 ea	15.00	lb

Sold in case pack or eaches.

KITCHEN

ECONOMY STAINLESS STEEL MIXING BOWLS

- Bright mirror-finished stainless steel
- Beaded edge
- Dishwasher safe
- Flat bottoms sit flat on countertops

Item #	Mfg. #	Description	Cs Pk	Cs Wt
379759	47932	1½ quart, 7¾" dia	12 x 1 ea	3.48 lb
379761	47933	3 quart, 9" dia	12 x 1 ea	5.52 lb
379762	47934	4 quart, 10½" dia	12 x 1 ea	6.72 lb
379764	47935	5 quart, 11¾" dia	12 x 1 ea	7.80 lb
379768	47938	8 quart, 13½" dia	12 x 1 ea	11.52 lb
379769	47943	13 quart, 16" dia	6 x 1 ea	10.38 lb
379771	47946	16 quart, 17½" dia	6 x 1 ea	11.46 lb



VOLLRATH
Setting the Standard

MEASURING CUP SET

- Stainless steel
- Heavy duty
- ¼, ½, ⅓ and 1 cup sizes

Item #476372
Mfg. #MEA-CUP
Cs Pk 12 x 1 set
Cs Wt 3.80 lb
Sold in case pack or set.



MEASURING SPOON SET

- Heavy gauge stainless steel
- Set includes ¼, ½, teaspoon and tablespoon measures

Item #482380
Mfg. #MEA-SPDX
Cs Pk 288 x 1 set
Cs Wt 3.88 lb
Sold in case pack or set.



update
International



TABLECRAFT
EVERY WARE, EVERY DAY.

STAINLESS STEEL MEASURING SPOONS & CUPS

- Measuring spoon set includes ¼, ½, teaspoon and tablespoon measures
- Measuring cup set includes ¼, ⅓, ½ and 1 cup measures

Item #	Mfg. #	Description	Cs Pk	Cs Wt
4 Pc. Measuring Spoon Sets				
380430	721	Standard	12 x 1 set	1.35 lb
397426	722	Heavy Duty	24 x 1 set	2.12 lb
Measuring Cups				
380434	724	4-Piece Set	12 x 1 set	4.50 lb
454345	724A	¼ Cup	24 x 1 ea	1.75 lb
454344	724C	½ Cup	24 x 1 ea	2.70 lb

Sold in case pack or polybagged sets.

TRANSFER DIPPER

- Dent resistant 3004 aluminum alloy
- Seamless construction with welded handle
- 11½" long, 30 oz capacity

Item #398315
Mfg. #5330
Cs Pk 3 x 1 ea
Cs Wt 2.56 lb
Sold in case pack or eaches.



VOLLRATH
Setting the Standard

ALUMINUM MEASURES

- Impact-resistant 3004 aluminum
- Specially designed lip for no-spill pouring
- Each embossed bar denotes ¼ of measurement
- Welded handles
- Cs Pk 6 x 1 ea



NSF

MADE IN USA

VOLLRATH
Setting the Standard

Item #	Mfg. #	Description	Cs Wt
535296	68296	1 quart	3.30 lb
524593	68351	2 quart	4.98 lb
527754	68352	4 quart	8.52 lb

Sold in case pack or eaches.

TABLECRAFT
EVERY WARE, EVERY DAY.

GRADUATED ALUMINUM MEASURES

- Graduations stamped on outside in ounces and liters
- Cs Pk 12 x 1 ea

Item #	Mfg. #	Description	Cs Wt
A. 380438	433	1 quart	7.85 lb
B. 380439	434	2 quart	12.75 lb
C. 380440	435	4 quart	17.80 lb

Sold in case pack or eaches.



CAMWEAR® MEASURING CUPS

- Measure liquid ounces, pints, quarts or liters
- Won't dent like metal, ensuring an accurate measurement every time
- Externally marked graduations in American standard and metric are molded-in
- Made of rugged, virtually unbreakable polycarbonate
- Molded-in handle won't break off

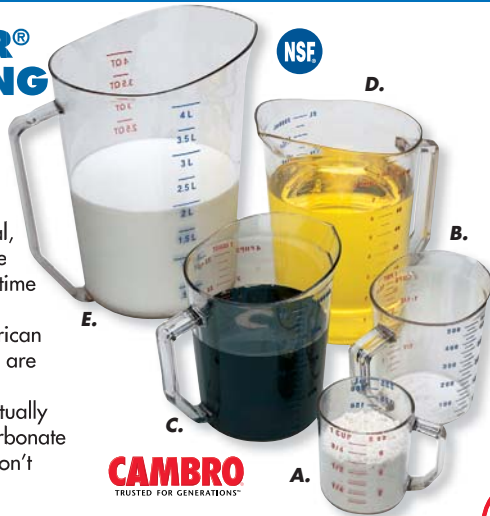

CAMBRO
TRUSTED FOR GENERATIONS™

Item #	Mfg. #	Description	Cs Pk	Cs Wt
A. 380140	25MCCW-135	1 cup	12 x 1 ea	2.16 lb
B. 380577	50MCCW-135	1 pint	12 x 1 ea	4.79 lb
C. 379665	100MCCW-135	1 quart	12 x 1 ea	6.83 lb
D. 380117	200MCCW-135	2 quart	12 x 1 ea	10.60 lb
E. 368231	400MCCW-135	4 quart	1 x 1 ea	1.56 lb

Sold in case pack or eaches.

CAMWEAR® SHAKERS/DREDGES

CAMBRO
TRUSTED FOR GENERATIONS™

- Crystal clear design lets you see what's inside
- Camwear polycarbonate will not break – dishwasher safe and unaffected by food acids
- 10 oz capacity
- Cs Pk 12 x 1 ea
- Cs Wt 3.08 lb



Item #	Mfg. #	Description
A. 380607	96SKRD-135	Beige, S & P Lid
B. 380606	96SKRC-135	Yellow, Cheese Lid

Sold in case pack or eaches.

SHAKER/DREDGE SET

TABLECRAFT
EVERY WARE, EVERY DAY.

- 10 oz polycarbonate shaker with 3 snap tight plastic color coded lids in Beige (Salt & Pepper), Rose (Medium Ground) and Yellow (Cheese)
- Dishwasher safe



Item #397415
Mfg. #166F
Cs Pk 12 x 1 ea
Cs Wt 4.02 lb
Sold in case pack or eaches.

DREDGES

- Choose from aluminum or stainless steel, each with handle
- 10 oz capacity
- Cs Pk 12 x 1 ea



Item #	Mfg. #	Description	Cs Wt
A. 380460	H158	Aluminum	1.20 lb
B. 380461	H159	Stainless Steel	2.76 lb

Sold in case pack or eaches.

TABLECRAFT
EVERY WARE, EVERY DAY.

SHAKER/DREDGE SET

ALLIED

- Super durable polycarbonate
- Dishwasher safe
- Stain resistant
- Packed with 3 lids (fine, medium, and coarse)
- 10 oz capacity



Item #482826
Mfg. #SD10
Cs Pk 12 x 1 ea
Cs Wt 3.75 lb
Sold in case pack or eaches.

DREDGE WITH HANDLE

- Stainless steel
- 10 oz capacity

Item #482343
Mfg. #DR-10
Cs Pk 12 x 1 ea
Cs Wt 2.70 lb
Sold in case pack or eaches.

update
international



DREDGES

VOLLRATH
Setting the Standard™

- 18 gauge aluminum
- Ideal for shaking salt, spices, and powdered sugar
- 155 holes
- 10 oz capacity
- Cs Pk 12 x 1 ea



Item #	Mfg. #	Description	Cs Wt
535300	68184	Dredge w/Handle	2.78 lb
535290	68183	Dredge w/o Handle	2.70 lb

Sold in case pack or eaches.

NSF

FUNNEL

- One-piece seamless design
- 16 oz capacity, 5 1/4" diameter
- White plastic

Item #476347
Mfg. #FPW-5
Cs Pk 24 x 1 ea
Cs Wt 0.70 lb
Sold in case pack or eaches.

update
international



FUNNEL SET

- Set includes 2", 3", 4", 5" and 6" diameter funnels
- White plastic

Item #423830
Mfg. #5
Cs Pk 12 x 1 set
Cs Wt 3.80 lb
Sold in case pack or set.



TABLECRAFT
EVERY WARE, EVERY DAY.



CAST ALUMINUM SCOOPS

- One piece construction with capacity stamped on handle
- Rounded handle with ergonomic finger grips
- Cs Pk 6 x 1 ea

Item #	Mfg. #	Description	Cs Wt
397863	5280	18 oz 6 x 1 ea	2.40 lb
535294	46892	23 oz 24 x 1 ea	14.40 lb
534708	46893	40 oz 24 x 1 ea	22.08 lb
528757	46894	55 oz 20 x 1 ea	22.00 lb

Sold in case pack or eaches.



CAMWEAR® SCOOPS

- Scoop dry bulk ingredients or ice
- Virtually unbreakable polycarbonate will not dent, chip or rust
- Molded-in sure grip handle includes a hole for hanging



Item #	Mfg. #	Capacity	Cs Pk	Cs Wt
380048	SCP6CW-135	6 oz	12 x 1 ea	2.50 lb
380045	SCP12CW-135	12 oz	12 x 1 ea	2.90 lb
380046	SCP24CW-135	24 oz	12 x 1 ea	3.90 lb
380047	SCP64CW-135	64 oz	6 x 1 ea	4.15 lb

Sold in case pack or eaches.



SCOOPS

- Clear polycarbonate
- Ultra durable and lightweight
- Cs Pk 12 x 1 ea



Item #	Mfg. #	Description	Cs Wt
482392	SCP-12C	12 oz	2.87 lb
482393	SCP-24C	24 oz	3.75 lb

Sold in case pack or eaches.

PORTION CONTROL

The key to profit control is portion control. Using a sandwich shop/deli as an example, if an employee serves ¼ ounce overweight with each serving of sandwich meat and 400 customers are served in a day, 6¼ pounds of additional food has been used. If the product cost \$1.50 per pound, the loss over the year would be \$3,420!. Weigh all ingredients in a recipe to ensure accurate measurements.

STAINLESS STEEL PORTION SCALE

- Six capacity display options: 10 lb x 0.1 oz/10 lb x 0.005 lb/10 lb x 1/8 oz/5000 g x 1 g/160 oz x 0.05 oz/160 oz x 1/8 oz
- All stainless steel body
- Dual Housing Technology™ provides moisture resistance
- 6" x 6¾" one-piece platform
- Dual voltage AC power supply and rechargeable battery pack included

Item #486780

Mfg. #EDL-10RB

Cs Pk 1 x 1 ea

Cs Wt 6.00 lb



DIGITAL PORTION CONTROL SCALE

- Cap: 160 oz x 0.1 oz or 5000 g x 1 g
- 5⅞" x 6¾" removable stainless steel platform
- Automatic push button tare
- 115V, AC adapter included
- Also operates on 9V battery (not included) with automatic shut-off

Item #454589

Mfg. #E-160

Cs Pk 1 x 1 ea

Cs Wt 4.00 lb



ELECTRONIC PORTION CONTROL SCALES

- Stainless steel platform
- Auto hold, auto shut-off and low battery indicator modes
- Operates on AC adapter (included) or 9V battery
- Weighs lb/oz or kg/g



Cap: 10 lb /5 kg

Item #469792

Mfg. #TE10R

Cs Pk 1 x 1 ea

Cs Wt 3.60 lb



Cap: 2 lb/2 kg

Item #487046

Mfg. #TE32C

Cs Pk 1 x 1 ea

Cs Wt 2.04 lb



Cap: 22 lb/10kg

Item #487047

Mfg. #TE22

Cs Pk 1 x 1 ea

Cs Wt 3.35 lb

Sold in case pack only.



COMPACT ANALOG PORTION CONTROL SCALES

- Antimicrobial housing
- Corrosion-resistant stainless steel construction
- Internal stop mechanism
- Cs Pk 1 x 1 ea



Cap: 32 oz x ¼ oz
Ice Cream With %
Of Overrun
Item #460120
Mfg. #TP32
Cs Wt 1.63 lb



Cap: 16 oz x ¼ oz,
w/Fixed French Fry/
Taco Holder
Item #460121
Mfg. #TP16FF
Cs Wt 1.75 lb



#TS32

#TS5

#TS25KL



TAYLOR.

ANALOG PORTION CONTROL SCALES

- Stainless steel chassis
- Rugged stainless steel construction
- Angled dial designs, protective shatterproof lenses and removable platforms
- Rotating dial • Cs Pk 1 x 1 ea

Item #	Mfg. #	Capacity	Cs Wt
460115	TS32	32 oz x ¼ oz	5.10 lb
460116	TS5	5 lb x ½ oz	4.50 lb
460117	TS25KL	25 lb x 2 oz, Dual Scale	4.50 lb
460118	TS50	50 lb x 4 oz	4.45 lb



#TS50

REGULAR DUTY SCALE

- Cap: 2 lb x ¼ oz/4.4 kg x 10 g
- Easy to remove and clean dial face w/acrylic lens • Enamel finish
- 7" dial, 7" platform

Item #482442

Mfg. #UP-72
Cs Pk 6 x 1 ea
Cs Wt 26.00 lb

Sold in case pack or eaches.



STAINLESS STEEL PORTION SCALE

- Cap: 32 oz x ¼ oz
- Stainless steel springs, mechanism and housing
- Rotatable dial
- Rustproof stainless steel platform, 7" x 8¾", w/air dashpot
- Field recalibratable
- Dishwasher safe
- Made in USA



Item #379167

Mfg. #DR-20P
Cs Pk 1 x 1 ea
Cs Wt 6.00 lb



#SR-2

#SR-5

#SR-25

STAINLESS STEEL PORTION SCALES

- Stainless steel springs, mechanism and housing
- Rotatable dial
- Rustproof stainless steel platform, 6" x 6¾"
- SR-2 is field recalibratable
- Dishwasher safe
- Cs Pk 1 x 1 ea • Cs Wt 5.00 lb

Item #	Mfg. #	Capacity
379175	SR-2	32 oz x ¼ oz
379178	SR-5	5 lb x 1 oz
378041	SR-25	25 lb x 4 oz



KITCHEN

HEAVY DUTY MECHANICAL SCALES

- Corrosion-resistant weighing mechanisms
- Dual measurement • NSF food grade platform
- Internal stop mechanisms, shatterproof lenses and bold dials
- Cs Pk 1 x 1 ea • Cs Wt 8.00 lb



50 lb x 2 oz w/9" x 9"
Stainless Steel Platform
Item #460122
Mfg. #THD50



32 oz x ⅛ oz w/9" x 9"
Stainless Steel
Platform & Dashpot
Item #460123
Mfg. #THD32D

TAYLOR.

RECEIVING SCALE

- Cap: 150 lb x 0.2 lb, 70 kg. x 0.1 kg
- Features lb/kg, auto tare, auto hold, auto shut off and low battery indicator modes
- 1" LCD remote display with 6 ft cord and mounting bracket
- 120V adaptor (included) or 6 AA batteries (not included)
- Removable stainless steel platform
- Non-skid feet

TAYLOR.



Item #460125
Mfg. #TE150
Cs Pk 1 x 1 ea
Cs Wt 11.60 lb

RECEIVING SCALE

- Heavy-duty w/Cap: 250 lb x 1 lb
- Ribbed 13" x 11" stainless steel platform
- Press down "Lock and hold" feature
- Built-in carrying handle
- Easy-to-read dial with shatterproof lens
- One year limited warranty

TAYLOR.



Item #460126
Mfg. #TR250SS
Cs Pk 1 x 1 ea
Cs Wt 13.00 lb

MANUAL CAN OPENER

- Stainless steel construction – comes apart easily for thorough cleaning and simple maintenance
- Dishwasher safe
- Opens most cans up to 14" h
- Convenient table style
- Corrosion-resistant
- 5 year warranty
- Made in USA

Item #379184
Mfg. #S-11
Cs Pk 1 x 1 ea
Cs Wt 10.00 lb



Etlund



ELECTRIC CAN OPENERS

- Countertop model – #10 cans slide into position and lock into place
- Effortless electric operation
- Durable stainless steel construction
- Replaceable knife and gear
- Stores out of the way when finished
- Spring-loaded – opens even dented cans
- Single handle operation
- Made in USA
- 115V



1 speed
Item #370033
Mfg. #266
Cs Pk 1 x 1 ea
Cs Wt 16.00 lb

Etlund



2 speed
Item #370006
Mfg. #203
Cs Pk 1 x 1 ea
Cs Wt 14.00 lb



CAN OPENER PARTS

Item #.	Mfg. #.	Description	Cs Pk	Cs Wt
485825	G003M	Gear for #1	24 x 1 ea	7.00 lb
485828	K004M	Knife for #1	24 x 1 ea	1.50 lb
485827	G004M	Gear for #2	24 x 1 ea	2.00 lb
485826	K005M	Knife for #2	24 x 1 ea	1.00 lb
370315	G030SP	Gear for S-11	1 x 1 ea	0.30 lb
370308	K032SP	Knife for S-11 or U-12	1 x 1 ea	0.10 lb
376992	K006SP	Knives for Electric Openers	1 x 1 ea	0.10 lb
376991	G006SP	Gears for Electric Openers	1 x 1 ea	0.30 lb

Sold in case pack or eaches.

MANUAL CAN OPENERS #1 & #2

- Plated base with plastic insert
- Rust resistant arbor
- Convenient table style
- Tempered steel reversible knife
- Tough cast iron construction
- Bright plated finish
- Opens most can shapes/sizes
- All parts replaceable
- Made in USA
- Cs Pk 1 x 1 ea



Item #.	Mfg. #.	Description	Cs Wt
368686	11100	#1 – With Base*	9.00 lb
426531	11000	#1 – Without Base*	7.30 lb
379156	12100	#2 – With Base**	5.00 lb

* Up to 50 cans/day **Up to 15 cans/day

Etlund

QUICK CHANGE MANUAL CAN OPENER

- Quick change gear, stainless steel shaft and pull pin for easy blade replacement
- Base design features replaceable insert for tighter fit and easy slide action
- Easily disassembled for increased sanitation
- Plated steel base
- Available with long or short bar lengths
- Made in USA

Item #379190
Mfg. #U-12
Cs Pk 1 x 1 ea
Cs Wt 21.00 lb



SWING-A-WAY® PORTABLE CAN OPENER

Item #380466
Mfg. #407
Cs Pk 12 x 1 ea
Cs Wt 8.00 lb
Sold in case pack or eaches.

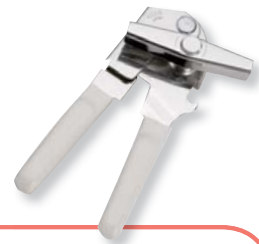

DRUM & PAIL OPENER

- Fits most 3/4" or 2" plastic drum bungs and standard open head pails
- High strength fiberglass filled plastic construction resists corrosion

Item #482654
Mfg. #250132
Cs Pk 6 x 1 ea
Cs Wt 1.80 lb
Sold in case pack or eaches.



CANPRO® COMPACT CAN OPENER

- Never replace gears – machine is gearless
- Opens cans without touching the inside of the can or food
- Side cutting prohibits the lids from falling into the can
- Easily opens up to #10 size cans
- Stainless steel shaft and cutter housing
- Permanent or portable mounting
- No sharp blades
- Cs Pk 1 x 1 ea

Item #453582
Mfg. #56050-1
Cs Wt 4.00 lb

Replacement Cutter
Item #457653
Mfg. #56029
Cs Wt 1.00 lb



"Exceeding your expectations"



PAIL OPENER

- Cast aluminum
- 16"l x 5"w

Item #380463
Mfg. #15
Cs Pk 6 x 1 ea
Cs Wt 5.62 lb
Sold in case pack or eaches.



GIANT CAN PUNCH

Item #482296
Mfg. #CO-7G
Cs Pk 12 x 1 ea
Cs Wt 2.32 lb
Sold in case pack or eaches.

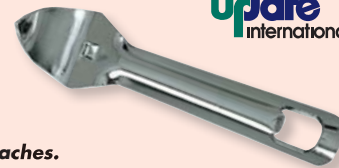

KITCHEN

REDCO® PREMIUM™ CAN OPENER

- Easily pierces cans up to 14" and 21" tall
- Eliminate unsafe frayed metal and shavings that can contaminate food
- Stainless steel base plate and steel shaft
- 2-year warranty
- Cs Pk 1 x 1 ea

Item #413971
Mfg. #BCO-1
Cs Wt 4.70 lb

Replacement Blade For BCO-1
Item #387710
Mfg. #BCO-11
Cs Wt 0.40 lb



CAN PUNCH

- King-size can punch/bottle opener – punches hole five times normal size
- Stainless steel

Item #379452
Mfg. #50SS
Cs Pk 12 x 1 ea
Cs Wt 3.00 lb
Sold in case pack or eaches.



CONTENTS OF STANDARD CANS

Can Number	Weight	Volume (Cups)
1	10-11 oz	1¼
300	15 oz	1¾
303	1 lb	2
1 Tall	1 lb	2
2	1 lb 3 oz	2½
2½	1 lb 13 oz	3½
3	1 qt 13 fl oz	3½
5	3 lb	5¾
10	6 lb 8 oz	12-13

BASTING MOP

- Long wood handle
- Leather hanging strap

Item #487157

Mfg. #02103P
Cs Pk 1 x 12 ct
Cs Wt 4.00 lb

Sold in case pack only.



SPARTA® VEGETABLE BRUSH

- Loop construction with stiff polyester bristles
- 9½" long
- Color: White

Item #397405

Mfg. #4016402
Cs Pk 12 x 1 ea
Cs Wt 2.68 lb

Sold in case pack or eaches.



SPARTA® POTATO BRUSH

- Medium stiff polyester bristles for aggressive cleaning along with a unique "scraper edge" grip for removing hard to reach blemishes on potatoes and other firm vegetables
- 5¾" long
- Color: White

Item #397402

Mfg. #4041202
Cs Pk 12 x 1 ea
Cs Wt 3.00 lb

Sold in case pack or eaches.



SPARTA® METEOR® BASTING BRUSHES

- "Molded into-the handle" hook – hangs on lip of crocks or other containers
- Hook elevates bristles off of counter tops to help prevent contamination
- Bleached, sterilized boar bristles are molded into the handle to prevent bacteria harboring air pockets
- Color: White
- Cs Pk 12 x 1 ea



Item #	Mfg. #	Description	Cs Wt
380803	4037800	2" Boar Bristle	1.96 lb
380804	4037900	3" Boar Bristle	2.50 lb

Sold in case pack or eaches.



GALAXY™ PASTRY BRUSHES

- One-piece, smooth plastic handles
- Bristles are epoxy-set to ferrules to prevent bacteria harboring air pockets
- Soft flagged nylon bristles have high fluid retaining capacity and are more durable than inexpensive Polypropylene bristle imitations
- Color: White
- Cs Pk 12 x 1 ea



#4039302

#4039202

#4039102

Item #	Mfg. #	Description	Cs Wt
380800	4039102	2" Flat Nylon	1.50 lb
380801	4039202	3" Flat Nylon	1.90 lb
380802	4039302	4" Flat Nylon	2.90 lb

Sold in case pack or eaches.



KITCHEN

SPARTA® CHEF SERIES™ PASTRY BRUSHES

- Professional, high quality lacquered hardwood handles with brown plastic ferrules
- Bristles are epoxy-set to ferrules to provide superior bristle retention and to prevent bacteria harboring air pockets
- Soft flagged nylon bristles have high fluid retaining capacity and a soft touch
- Color: White

Item #	Mfg. #	Description	Cs Pk	Cs Wt
388948	4039600	1½" Nylon Bristle	12 x 1 ea	1.36 lb
380820	4039700	2" Nylon Bristle	12 x 1 ea	1.70 lb
380818	4039800	3" Nylon Bristle	12 x 1 ea	2.90 lb
380825	4039900	4" Nylon Bristle	12 x 1 ea	4.36 lb

Sold in case pack or eaches.



#4039600

#4039800

#4039700

#4039900



SPARTA® CHEF SERIES™ BASTING BRUSHES

- High quality lacquered hardwood handles with brown nylon ferrules
- Bristles are epoxy-set to ferrules to provide superior bristle retention and to prevent bacteria harboring air pockets
- Sterilized, bleached boar bristles can withstand temperatures of 500°F
- "Long Reach" (4037000) brush has 12" handle bent at a 45° angle to keep hands away from hot grills
- Color: White
- Cs Pk 12 x 1 ea

Item #	Mfg. #	Description	Cs Wt
380809	4037000	2" Flat Boar Bristle w/12" Handle	2.95 lb
380812	4037300	1½" Flat Boar Bristle	1.36 lb
380814	4037400	2" Flat Boar Bristle	1.75 lb
397281	4037500	3" Flat Boar Bristle	3.10 lb
388949	4037600	4" Flat Boar Bristle	4.65 lb
380823	4038000	1" Round Boar Bristle	2.26 lb

Sold in case pack or eaches.



#4037000

#4037600

#4037300

#4037500

#4037400

#4038000



INDIVIDUAL ROLLING PIN

- 1 3/4" diameter barrel
- 5 1/2" wide
- Smooth barrel, no pins

ALLIED

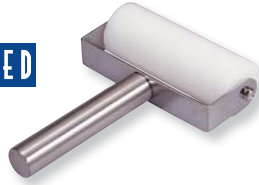

Item #482750
Mfg. #IRP5
Cs Pk 1 x 1 ea
Cs Wt 1.50 lb

POLY-ROLL® ROLLING PIN

- Non-porous, non-absorbent, stain resistant high-density polyethylene will not chip, crack or peel
- Dishwasher and sanitizer safe
- Heavy-duty design provides even-pressure rolling
- No unsanitary bearings or barrel cavities
- Super stick-resistance when chilled
- Perfect for preparing pie crusts, biscuits, pastries
- 15" long

NSF

Item #395917
Mfg. #RP15
Cs Pk 1 x 1 ea
Cs Wt 4.00 lb

SAN JAMAR
Smart → Safe → Sanitary

ROLLING PINS

- Wood
- Ball bearing mechanism
- 3 1/2" diameter
- Cs Pk 3 x 1 ea



Item #	Mfg. #	Description	Cs Wt
476414	RPW-3215	15" long	10.00 lb
476415	RPW-3218	18" long	13.00 lb

Sold in case pack or eaches.

ROLLING PIN

- Aluminum
- Ball bearing mechanism
- 3 1/2" diameter, 18" long

Item #476413
Mfg. #RPA-3518
Cs Pk 6 x 1 ea
Cs Wt 24.00 lb

Sold in case pack or eaches.



update
international

BUTCHER STRING

- Heavy-duty, 16 ply, 2 lb cone

Item #432007
Mfg. #RPTW
Cs Pk 5 x 1 roll
Cs Wt 10.00 lb

Sold in case pack or eaches.



Arden™
Benhar
Foodservice & Institutional

DOUGH CUTTER/SCRAPER

- Polypropylene handle and stain-free, high-carbon steel blade
- 6" x 3"
- Made in USA

DEXTER
THE EDGE SINCE 1818

Item #437813
Mfg. #S196PCP
Cs Pk 6 x 1 ea
Cs Wt 2.38 lb

Sold in case pack or eaches.



BENCH/FLOUR BRUSH

- 9 1/2" x 2 1/2" x 14" OA

Item #484776
Mfg. #KBL9
Cs Pk 12 x 1 ea
Cs Wt 9.00 lb

Sold in case pack or eaches.



ALLIED

COOKIE/BISCUIT & DOUGHNUT CUTTER

- Stainless steel
- 3" diameter
- Cs Pk 12 x 1 ea
- Cs Wt 3.00 lb



#CBC3

#DNC3

Item #	Mfg. #	Description
482687	CBC3	Cookie/Biscuit
482769	DNC3	Doughnut

Sold in case pack or eaches.

ALLIED

PASTRY BLENDER

- Stainless steel

Item #482763
Mfg. #PB10
Cs Pk 1 x 1 ea
Cs Wt 0.50 lb



ALLIED

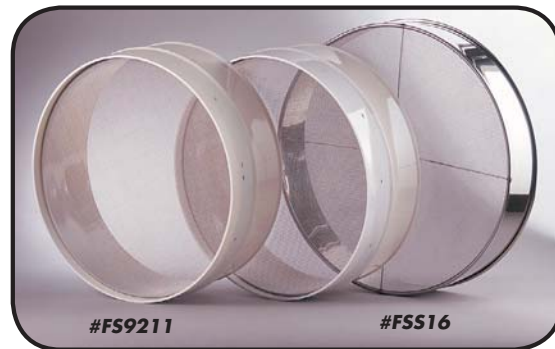

#FS9211

#FSS16

FLOUR SIEVES

- Stainless steel web
- Dishwasher safe
- Color: White
- Cs Pk 1 x 1 ea

ALLIED

Item #	Mfg. #	Description	Cs Wt
482748	FS9211	12" diameter, Polycarbonate Frame	1.00 lb
482749	FSS16	16" diameter, Stainless Steel Frame	1.55 lb

KITCHEN

ALLIED

PIPING TIP SETS

- Made of polypropylene
- Large tips
- Cs Pk 1 x 1 set



#PTSL893



#PTSL903

Item #	Mfg. #	Description	Cs Wt
484786	PTSL893	4 Star Tips (3, 5, 7, 9), 4 Hole Tips (5, 7, 9, 11), 4 Garnishing Tips	6.20 lb
484787	PTSL903	4 Star Tips (11, 13, 15, 17), 4 Hole Tips (11, 13, 15, 17), 4 Garnishing Tips	6.20 lb

Sold in set only.

"EXPORT" PASTRY BAGS

- Cotton w/plastic coating
- Dishwasher safe
- Heavy duty
- Cs Pk 12 x 1 ea
- Cs Wt 12.00 lb

ALLIED



Item #	Mfg. #	Description
482768	PBE3110	12" long
482764	PBE3020	14" long
482765	PBE3030	16" long
482766	PBE3040	18" long
482767	PBE3060	21" long

Sold in case pack or eaches.

CAKE RING

- Stainless steel
- Deburred edges
- 2 3/8" h x 3" diameter

Item #482729
Mfg. #CRS3238
Cs Pk 12 x 1 ea
Cs Wt 3.00 lb



ALLIED

Sold in case pack or eaches.



PAN/ICING GRATE

- Perfect for icing baked goods
- 16" x 24"

Item #484785
Mfg. #WG1624
Cs Pk 6 x 1 ea
Cs Wt 28.00 lb

ALLIED

Sold in case pack or eaches.

ICING/COOLING RACK

- Chrome plated
- Wire with built-in feet
- 24 3/4" l x 16 1/8" w

Item #476362
Mfg. #IG-1624
Cs Pk 6 x 1 ea
Cs Wt 15.50 lb

Sold in case pack or eaches.

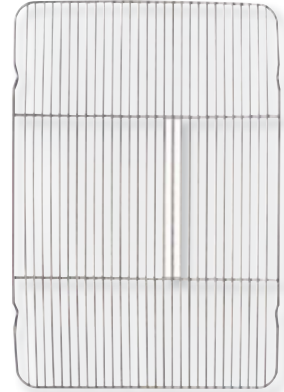

update
international



COOLING RACK

- Ideal for cooling bread, muffins, cakes, pastries and all other types of baked goods
- Chrome plated
- 17" x 25"

Item #484791
Mfg. #CR-1725
Cs Pk 6 x 1 ea
Cs Wt 15.00 lb

Sold in case pack or eaches.



#TCP9



#TCP750



#TCP925



#TCP95R

ANGEL/CAKE TUBES

- Cs Pk 6 x 1 ea

ALLIED

Item #	Mfg. #	Description	Cs Wt
482867	TCP9	9 1/2" x 8" x 2"; Center Cone 2 3/4" (18 ga)	3.75 lb
482866	TCP750	7 1/2" x 6 1/2" x 3"; Center Cone 2 1/2" (16 ga)	4.13 lb
482868	TCP925	9 1/2" x 7 1/2" x 5 1/2"; Center Cone 1 3/8" (14 ga)	5.63 lb
482869	TCP95R	Removable Bottom, 9 1/2" x 8 1/4" x 4 1/8"; Center Cone 1 3/8" (21 ga)	3.75 lb

Sold in case pack or eaches.

WEAR-EVER® CAKE PAN

- 3000 series aluminum
- 10" x 2"
- Made in USA



Item #398070
Mfg. #51016
Cs Pk 6 x 1 ea
Cs Wt 3.56 lb
Sold in case pack or eaches.

ALLIED

CAKE PANS

- Cs Pk 12 x 1 ea



Item #	Mfg. #	Description	Cs Wt
18 Gauge Aluminum - 2" Straight Sided			
482706	CP6X2	6" diameter	3.75 lb
482707	CP8X2	8" diameter	6.00 lb
484789	CP9X2	9" diameter	7.20 lb
482699	CP10X2	10" diameter	8.25 lb
482700	CP12X2	12" diameter	10.50 lb
482704	CP14X2	14" diameter	13.20 lb
16 Gauge Aluminum - 3" Straight Sided			
482708	CPH10X3	10" diameter	11.25 lb

Sold in case pack or eaches.

WEAR-EVER® LOAF PANS

- 3000 series aluminum
- Sanitary and easy to clean
- Cs Pk 6 x 1 ea



#51008



#5431



Item #	Mfg. #	Description	Cs Wt
Economy - 18 gauge			
424429	51008*	Open Bead, 9 1/4" x 5 1/4" x 2 3/4"	3.26 lb
Professional Standard Strength - 12 gauge, NSF			
397866	5435	Anodized, 5" x 10" x 4"	7.78 lb

Sold in case pack or eaches. *Made in the U.S.A.

SPRING FORM PANS

- 2 1/2" deep
- Bright tin plate
- Cs Pk 6 x 1 ea



Item #	Mfg. #	Description	Cs Wt
482828	SF875	8" diameter	1.88 lb
482829	SF95	9" diameter	2.25 lb
482827	SF1025	10" diameter	2.25 lb

Sold in case pack or eaches.

MUFFIN PANS

- Heavy weight aluminum
- Cs Pk 6 x 1 ea



#MP12



Item #	Mfg. #	Description	Cs Wt
482754	MP12	11" w x 14 1/2" l, 12 cup	7.80 lb
482755	MP24	14" w x 20 1/2" l, 24 cup	16.50 lb

Sold in case pack or eaches.

MUFFIN/CUP CAKE PANS

- 1.0mm heavy aluminum
- Cups seamed into frame
- Cup top 2 3/4" diameter, cup bottom 1 5/8" diameter



#MPA-24

12 Cup
• Economy Series
Item #476373
Mfg. #MPA-12
10 3/4" w x 14 1/8" l x 1 1/8" h
Cs Pk 24 x 1 ea
Cs Wt 35.00 lb
Sold in case pack or eaches.

24 Cup
Item #476374
Mfg. #MPA-24
14 1/8" w x 20 5/8" l x 1 1/8" h
Cs Pk 12 x 1 ea
Cs Wt 32.00 lb
Sold in case pack or eaches.

CAKE PANS

- 16 and 18 gauge aluminum
- Removable bottom
- Cs Pk 12 x 1 ea



Item #	Mfg. #	Description	Cs Wt
482691	CCPSET8X2	8" diameter x 2" deep, 16 ga	8.25 lb
482688	CCPSET10X2	10" diameter x 2" deep, 16 ga	11.25 lb
482689	CCPSET10X3	10" diameter x 3" deep, 18 ga	14.40 lb

Sold in case pack or eaches.

PIE MARKERS

- Aluminum
- Provide even portions
- Cs Pk 12 x 1 ea



Item #	Mfg. #	Description	Cs Wt
476314	APM-06	6 Cut	3.50 lb
476315	APM-07	7 Cut	3.90 lb
476316	APM-08	8 Cut	4.10 lb
476317	APM-10	10 Cut	4.18 lb
476318	APM-12	12 Cut	4.50 lb

Sold in case pack or eaches.



ALLIED

SILPATS FITTED BAKING MATS

- Cs Pk 3 x 1 ea

Item #	Mfg. #	Description	Cs Wt
Full Size			
482830	SPF4262	18" x 26"	1.50 lb
Half Size			
482832	SPH2295	11 7/8" x 16 1/2"	1.13 lb

Sold in case pack or eaches.

WEAR-EVER® PIE PLATE

- 3000 series anodized aluminum
- 10" diameter x 1 1/4" deep

Item #397638

Mfg. #51045

Cs Pk 6 x 1 ea

Cs Wt 2.60 lb

Sold in case pack or eaches.



ALUMINUM SHEET PANS

- Closed bead with galvanized wire for rust resistance and reinforcement
- 3003 aluminum



Item #	Mfg. #	Description	Cs Pk	Cs Wt
Full Size, 18" x 26"				
504980	ALXP-1826	18 gauge	1 x 1 dz	36.00 lb
504982	ALXP-2618H	16 gauge	1 x 1 dz	38.00 lb
1/2 Size, 13" x 18"				
507097	ALXP-1318		1 x 1 dz	21.60 lb
1/4 Size, 9 1/2" x 13"				
504975	ALXP-1013		1 x 2 dz	21.60 lb

Sold in case pack only.

PIE PANS

- Cs Pk 12 x 1 ea



ALLIED

Item #	Mfg. #	Description	Cs Wt
482742	FP209	9" Top, 7" Bottom, 1 1/4" deep	4.50 lb
482744	FP210	10" Top, 8" Bottom, 1 1/2" deep	6.00 lb
482745	FP211	11" Top, 9" Bottom, 1 1/2" deep	6.75 lb
482746	FP212	12" Top, 10" Bottom, 1 1/2" deep	3.00 lb

Sold in case pack or eaches.

WEAR-EVER® HEAVY-DUTY SHEET PANS

- Impact-resistant 3000 series aluminum
- Tapered design for easy stacking
- Sized to fit standard baker's racks
- Concave bottoms flatten during heating for even heat distribution
- Closed bead includes galvanized non-rusting rod for reinforcements
- Perforated pans for oven broiling and baking
- Natural finish
- Cs Pk 1 x 1 dz

Item #	Mfg. #	Description	Cs Wt
Full Size - 18" x 26" x 1"			
369607	9001	Solid, 16 gauge	46.90 lb
369599	9002	Solid, 18 gauge	37.42 lb
378485	9002P	Perforated, 18 gauge	38.00 lb
Half Size - 18" x 13" x 1"			
369600	5303	Solid, 18 gauge	23.90 lb
Quarter Size - 9 1/2" x 13" x 1"			
378484	5220	Solid, 16 gauge	10.44 lb

Sold in case pack only.



SQUEEZE DISPENSER

- Ideal for ketchup, mustard and special sauces, even refilling salt and pepper shakers
- Flexible polyethylene with leak-proof screw-on spout cap
- 24 oz
- Clear



Item #492490

Mfg. #5224-13
Cs Pk 1 x 1 dz
Cs Wt 4.00 lb

Sold in case pack only.



SQUEEZE BOTTLES

- These plastic bottles offer easy content recognition
- Ideal for self-serve and high volume areas



Item #	Mfg. #	Description	Cs Pk	Cs Wt
483638	SBC-12	12 oz, Clear	1 x 6 ea	1.00 lb
482387	SBR-12	12 oz, Red	1 x 6 ea	1.00 lb
482390	SBY-12	12 oz, Yellow	1 x 6 ea	1.00 lb
482388	SBC-16W	16 oz, Clear, Wide Mouth	1 x 6 ea	1.25 lb

Sold in case pack only.



SQUEEZE DISPENSER

- Low density polyethylene with no-drip design helps prevent table and counter mess
- 12 oz • Clear
- Made in USA



Item #368251

Mfg. #52063
Cs Pk 12 x 1 ea
Cs Wt 1.56 lb

Sold in case pack or eaches.



KETCHUP STATION & KETCHUP COUPLER™

- Gravity fed
- Quick, efficient, reduces waste
- Dishwasher safe
- Station has keyholes for mounting

Ketchup Station
Grey, 15¼" x 3½" x 11¼"h

Item #380198

Mfg. #KK33
Cs Pk 1 x 1 ea
Cs Wt 2.14 lb



Ketchup Coupler™
White

Item #380405

Mfg. #K26
Cs Pk 12 x 2 ea
Cs Wt 2.00 lb

Sold in case pack or eaches.



KITCHEN

SQUEEZE DISPENSERS

- Soft polyethylene, perfect "flex"
- Will not leak



Item #	Mfg. #	Description	Cs Pk	Cs Wt
Ketchup, Mustard & Natural Dispensers				
380200	108C-1	Natural, Translucent, 8 oz	1 x 1 dz	1.36 lb
380201	108K-1	Ketchup, Red, 8 oz	1 x 1 dz	1.36 lb
380202	108M-1	Mustard, Yellow, 8 oz	1 x 1 dz	1.36 lb
380203	112C-1	Natural, Translucent, 12 oz	1 x 1 dz	1.65 lb
380204	112K-1	Ketchup, Red, 12 oz	1 x 1 dz	1.65 lb
380205	112M-1	Mustard, Yellow, 12 oz	1 x 1 dz	1.65 lb
380206	124C-1	Natural, Translucent, 24 oz	1 x 1 dz	2.02 lb
380207	32C	Natural, Translucent, 32 oz	1 x 1 dz	2.02 lb
Wide Mouth Dispensers				
448611	11253C	Natural, Standard Cone Tip, Clear, 12 oz	1 x 3 dz	5.40 lb
394246	11663C	Natural, Standard Cone Tip, Clear, 16 oz	1 x 2 dz	4.12 lb
415249	31763C	Natural, Wide Cone Tip, Clear, 16 oz	1 x 2 dz	4.24 lb
394249	12463C	Natural, Standard Cone Tip, Clear, 24 oz	1 x 1 dz	2.60 lb
397997	3263C	Natural, Standard Cone Tip, Clear, 32 oz	1 x 1 dz	3.00 lb
Hinged Top Dispensers				
399064	2108C-1	Natural, Translucent, 8 oz	1 x 1 dz	1.36 lb
402228	2112C-1	Natural, Translucent, 12 oz	1 x 1 dz	1.55 lb
399066	2124C-1	Natural, Translucent, 24 oz	1 x 1 dz	2.04 lb
Tops - Fit all of above except wide mouth dispensers				
399065	200TC	Hinged, White	1 x 1 dz	0.84 lb
391425	100TC	Natural	1 x 1 dz	1.38 lb

Sold in case pack only.



Natural

Wide Mouth

Ketchup

Mustard

Hinged

ECONOMY PUMP DISPENSERS

- Allows for clean and efficient dispensing of condiments, sauces or light syrups
- 1 oz plastic pump
- Kit includes: pump (662), 9" dip tube and one each of 38mm, 89mm and 110mm screw caps, NT110mm and 160mm snap caps



Item #	Mfg. #	Description	Cs Pk	Cs Wt
380210▼	662K	Pump Kit	1 x 1 set	0.50 lb
380208▼	662	Pump Only	1 x 1 dz	1.30 lb
Pump with Cap and 9" Dip Tube				
394214	66238	w/38mm Snap Cap	12 x 1 ea	2.20 lb
397419	662110	w/110mm Screw Cap	12 x 1 ea	3.00 lb
397421	662160	w/160mm Snap Cap	12 x 1 ea	3.46 lb

Sold in case pack or eaches. ▼ Sold in case pack only.

CONDIMENT PUMP KIT

- Wide mouth design is ideal for chunky products such as salsa, relish, tartar sauce, dressings, etc.
- Kit includes: 1 oz Maxi Pump, 9" dip tube, 38mm, 89mm and 110mm screw caps, NT110mm and 160mm snap caps



Item #431453
Mfg. #664K
Cs Pk 6 x 1 kit
Cs Wt 3.54 lb
Sold in case pack or eaches.

EZ-CHILL® CONDIMENT PUMP BOXES

- Ice liner allows dispensing of condiment directly or use of Ez-chill® packets to cool condiment container
- Includes P7500 Ultra pump (w/9" dip tube) to dispense food directly from container, ice liner, Ez-chill® packs and label packet
- 22 gauge, 304 stainless construction

Box for 1 gallon Jar
17½"h x 7⅞"w x 7⅞"d

Item #380942
Mfg. #P9800
Cs Pk 1 x 1 ea
Cs Wt 4.90 lb

Box for #10 Can
14½"h x 7⅞"w x 7⅞"d

Item #380943
Mfg. #P9810
Cs Pk 1 x 1 ea
Cs Wt 4.30 lb



PANCAKE BATTER DISPENSERS

- Eight portion control settings ½ oz to 3 oz for uniform pancakes
- 13" high x 6½" wide
- Cs Pk 1 x 1 ea



#PCD-13

#PCD-13/SS

Item #	Mfg. #	Description	Cs Wt
486744	PCD-13	Aluminum	2.30 lb
481088	PCD-13/SS	Stainless Steel	4.20 lb

DISPENSER STAND

- Chrome plated • 6" base, 6¼"high

Item #476388
Mfg. #PCD-STD
Cs Pk 6 x 1 ea
Cs Wt 3.20 lb



Sold in case pack or eaches.

THE BATTER BOSS® PORTION CONTROL DISPENSER

- 48 oz capacity
- Eight portion control settings, varying from one ounce up to three ounces
- Includes two diffusers: one with a single-opening and one with 6 openings
- Designed to accurately dispense pancake, waffle and hush puppy batters – can also be used for dispensing sauces such as pizza sauce
- Includes clear lid and legs
- Disassembly is easy – dishwasher safe
- Almond



Item #380881
Mfg. #2803-18
Cs Pk 1 x 1 ea
Cs Wt 1.75 lb



KITCHEN

ULTRA PUMP

- Durable fixed nozzle for a wide variety of condiments, sauces, syrups, etc.
- Dispenses 1 oz portions • 9" dip tube

Item #389743
Mfg. #P7500
Cs Pk 1 x 2 ea
Cs Wt 0.50 lb



Sold in case pack only.

ECONOMY PUMP

- Reusable or disposable pump for a wide variety of condiments, sauces, syrups, dressings and toppings
- Dispenses 1 oz portions
- High-impact plastic construction

Item #389741
Mfg. #P7300
Cs Pk 1 x 2 ea
Cs Wt 2.80 lb



Sold in case pack only.



ALL PURPOSE DISPENSER

- 48 oz polyethylene with ABS top
- Dishwasher safe
- Almond top

Item #496978

Mfg. #748A

Cs Pk 1 x 6 ea

Cs Wt 2.80 lb

Sold in case pack only.



SERVERS

- 48 oz white polyethylene jar w/plastic top
- Perfect for batters/syrups in the kitchen or front of the house
- Cs Pk 6 x 1 ea

Item #	Mfg. #	Description	Cs Pk	Cs Wt
382405	4748-05	White Top	6 x 1 ea	2.80 lb
382406	4748-18	Almond Top	6 x 1 ea	2.88 lb

Sold as complete unit.

Sold in case pack or eaches.



A.

FRY BAGGER™ FRENCH FRY SCOOPS

- Made of super-tough, temperature-resistant plastic alloy to withstand temperatures from -40° to +300°F
- Will not dent, break or crack, and is unaffected by heat lights, salt and grease
- 9" x 8" x 2"
- Color: Silver

Item #	Mfg. #	Description	Cs Pk	Cs Wt
A. 380875	3670	Right Handle	6 x 1 ea	3.99 lb
B. 380878	3672	Dual Handle	6 x 1 ea	4.99 lb

Sold in case pack or eaches.

FRENCH FRY RACK

- Heavy gauge, brushed finish stainless steel rack fits standard 12" x 20" pan
- Holds up to 21 bags
- 10" x 18" x 2½"

C. Item #380880

Mfg. #3681

Cs Pk 1 x 1 ea

Cs Wt 2.45 lb

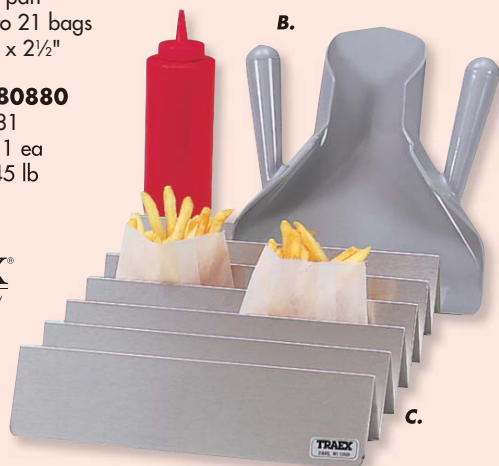

B.

C.



EVERY WARE, EVERY DAY

OPTION™ DISPENSERS

- Clear polycarbonate with Grey ABS top
- Ideal for juices, dressings, batters, oils, mixers, etc.
- Graduations on side in ounces and milliliters
- Sanitary integral handle provides complete pouring control
- Jar is dishwasher and microwave safe

Item #	Mfg. #	Description	Cs Pk	Cs Wt
432715	L32	32 oz, Grey Top	6 x 1 ea	2.40 lb
397451	L48	48 oz, Grey Top	6 x 1 ea	2.95 lb

Sold in case pack or eaches.



A Libby FOODSERVICE Company



#4843-06

#4842-01

SELF-SERVE SYSTEMS

- These three tier sets can be expanded or reduced in size as needed – each set includes three bins and clips
- Larger bins (11¼" long) are for items such as flatware or straws
- Smaller bins (8" long) are for items such as jelly packets, tea, salt, etc.
- Bins may be stacked, used individually or wall mounted
- Cs Pk 1 x 1 set

Item #	Mfg. #	Description	Cs Wt
380824	4842-01	with 8" Bins, Brown	5.00 lb
436215	4843-06	with 11¼" Bins, Black	6.00 lb
380826	4843-01	with 11¼" Bins, Brown	6.00 lb



BAMBOO STEAMER SET

- Each steamer set features 3 tiers plus lid
- Ideal for steaming vegetables, fish and chicken

10" diameter

#482684

Mfg. #BST10

Cs Pk 10 x 1 ea

Cs Wt 22.00 lb

Sold in case pack or eaches.



WOK BRUSHES

- Wood handles
- Palmyra bristles

Item #	Mfg. #	Description	Cs Pk	Cs Wt
485201	WK850	8½" Long	12 x 1 ea	8.00 lb
485204	WK2000	20" Long	6 x 1 ea	9.00 lb

Sold in case pack or eaches.

MANCHURIAN WOK

- 16" diameter

#482757

Mfg. #MWOK16

Cs Pk 5 x 1 ea

Cs Wt 40.00 lb

Sold in case pack or eaches.



WOKS

- Steel wire handles
- Cold rolled steel
- Wok ring sold separately
- Cs Pk 5 x 1 ea

Item #	Mfg. #	Description	Cs Wt
482886	WS14	14" diameter	25.00 lb
482887	WS20	20" diameter	40.00 lb

Sold in case pack or eaches.



WOK RING

- Fits 12" to 20" woks

Deluxe

#482884

Mfg. #WR1S

Cs Pk 10 x 1 ea

Cs Wt 6.25 lb

Sold in case pack or eaches.



CLEAVER

- 12½" blade
- Stainless steel



#482698

Mfg. #CL2

Cs Pk 12 x 1 ea

Cs Wt 9.00 lb

Sold in case pack or eaches.

WOK COOKING

Why use a stir-fry pan or wok? When stir-frying meats and vegetables, the bite-sized ingredients are stirred constantly and quickly over high heat in a small amount of oil. Stir-frying is an ideal way to preserve the color, flavors and textures of food, as well maintain their nutritional value. Using the proper cookware for stir-fry will ensure results your customers will devour. Because stir-fry pans and woks are slope sided and deep, they require less oil than a saute pan or skillet. Stir-fry pans and woks constructed of aluminum are the best choice because aluminum is an excellent conductor of heat. Because of this, heat spreads quickly and evenly across the bottom and up the sides, completely surrounding the food being cooked.

PIZZA PANS

- 18 gauge aluminum
- Made in USA
- Cs Pk 12 x 1 ea



A.



B.



Item #	Mfg. #	Description	Cs Wt
A. 1" Tapered Rim			
482722	CPT7X1	7" diameter	4.50 lb
482723	CPT8X1	8" diameter	5.25 lb
482724	CPT9X1	9" diameter	6.00 lb
482711	CPT10X1	10" diameter	6.00 lb
482713	CPT12X1	12" diameter	9.00 lb
482716	CPT14X1	14" diameter	11.25 lb
482719	CPT16X1	16" diameter	13.20 lb
B. 2" Tapered Rim			
482715	CPT12X2	12" diameter	10.50 lb
482717	CPT14X2	14" diameter	12.00 lb

Sold in case pack or eaches.



PIZZA TRAYS

- 18 gauge aluminum
- Wide rim
- Economy Series
- Cs Pk 12 x 1 ea

Item #	Mfg. #	Description	Cs Wt
476286	PT-WR9	9" diameter	3.50 lb
476290	PT-WR11	11" diameter	5.20 lb
476291	PT-WR12	12" diameter	5.60 lb
476292	PT-WR13	13" diameter	6.30 lb
476293	PT-WR14	14" diameter	7.90 lb
476294	PT-WR15	15" diameter	8.10 lb
476284	PT-WR16	16" diameter	9.63 lb
476285	PT-WR17	17" diameter	10.00 lb

Sold in case pack or eaches.

PIZZA PANS

- Non-stick Black BusterSM coating
- 22 gauge steel
- 1½" deep, straight sided
- Cs Pk 12 x 1 ea



Item #	Mfg. #	Description	Cs Wt
482837	SRP12X15	12" diameter	18.00 lb
482839	SRP14X15	14" diameter	24.00 lb
482847	SRP16X15	16" diameter	30.00 lb

Sold in case pack or eaches.



PIZZA TRAYS

- Wide rim
- Cs Pk 12 x 1 ea

Item #	Mfg. #	Description	Cs Wt
18 Gauge Aluminum			
482861	T7	7" diameter	3.75 lb
482862	T8	8" diameter	4.13 lb
482863	T9	9" diameter	4.50 lb
482849	T10	10" diameter	4.88 lb
482850	T11	11" diameter	5.48 lb
482851	T12	12" diameter	6.75 lb
482852	T13	13" diameter	7.88 lb
482853	T14	14" diameter	9.38 lb
482854	T15	15" diameter	10.31 lb
482855	T16	16" diameter	11.63 lb
482856	T17	17" diameter	14.40 lb
482857	T18	18" diameter	15.00 lb
482858	T19	19" diameter	18.00 lb
20 Gauge Aluminum			
482859	T20	20" diameter	18.00 lb

Sold in case pack or eaches.

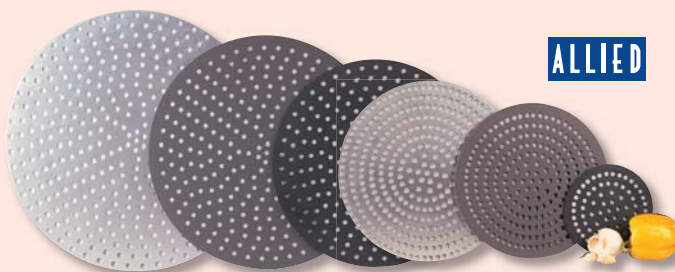

BAKING DISCS

- Perforated, ⅜" diameter holes
- 18 gauge aluminum
- Cs Pk 12 x 1 ea

Item #	Mfg. #	Description	Cs Wt
482772	PD10	10" diameter	4.00 lb
482774	PD12	12" diameter	6.00 lb
482776	PD14	14" diameter	7.50 lb
482778	PD16	16" diameter	9.75 lb
482779	PD17	17" diameter	11.25 lb
482808	PD18	18" diameter	12.00 lb

Sold in case pack or eaches.

PIZZA SCREENS

- Expanded aluminum
- Cs Pk 12 x 1 ea

ALLIED

Item #	Mfg. #	Description	Cs Wt
482818	PS6	6" diameter	1.50 lb
482820	PS7	7" diameter	1.50 lb
482815	PS20	20" diameter	15.00 lb
482816	PS24	24" diameter	9.00 lb
482817	PS28	28" diameter	12.00 lb

Sold in case pack or eaches.



#P1225

ALLIED

ALUMINUM BLADE PIZZA/BAKERS PEELS

- 14 gauge aluminum blade
- Wood handle
- Made in USA
- Cs Pk 4 x 1 ea

Item #	Mfg. #	Description	Cs Wt
523240	P1225	12" x 14" blade, 27" OA	12.00 lb
523226	P1235	12" x 14" blade, 36" OA	13.00 lb
523229	P1438	14" x 16" blade, 38" OA	13.00 lb
523228	P1618S	16" x 18" blade, 40" OA	14.00 lb
523227	P1252	12" x 14" blade, 52" OA	29.00 lb

Sold in case pack or eaches.



#WP236

ALLIED

#WP1436

WOOD PIZZA PEELS

- Cs Pk 4 x 1 ea

Item #	Mfg. #	Description	Cs Wt
22" long overall			
523237	WP1222	12" x 14" blade, 8" handle	16.00 lb
32" long overall			
515653	WP1832	18" x 18" blade, 14" handle	18.00 lb
36" long overall			
523238	WP236	16" x 29½" blade, 6½" handle	18.00 lb
523239	WP336	18" x 29½" blade, 6½" handle	26.00 lb
523230	WP1236	12" x 14" blade, 22" handle	12.00 lb
523232	WP1436	14" x 16" blade, 20" handle	13.00 lb
42" long overall			
523231	WP1242	12" x 14" blade, 28" handle	12.00 lb
523233	WP1442	14" x 16" blade, 26" handle	14.00 lb
523234	WP1642	16" x 18" blade, 24" handle	14.00 lb
523235	WP1842	18" x 18" blade, 24" handle	18.00 lb
523236	WP2042	20" x 21" blade, 21" handle	18.00 lb

Sold in case pack or eaches.

PIZZA SCREENS

- Seamless rim eliminates rough or bent edges
- Aluminum
- Economy series
- Cs Pk 12 x 1 ea

update
international

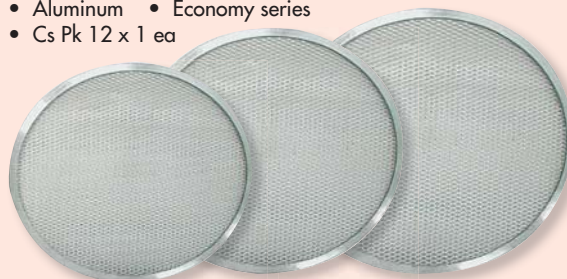

Item #	Mfg. #	Description	Cs Wt
476400	PS-08	8" diameter	1.80 lb
476295	PS-09	9" diameter	2.25 lb
476401	PS-10	10" diameter	2.25 lb
476296	PS-11	11" diameter	2.98 lb
476297	PS-12	12" diameter	3.31 lb
476402	PS-13	13" diameter	3.62 lb
476298	PS-14	14" diameter	4.06 lb
476299	PS-15	15" diameter	4.56 lb
476300	PS-16	16" diameter	4.81 lb
476403	PS-17	17" diameter	5.19 lb
476404	PS-18	18" diameter	5.37 lb

Sold in case pack or eaches.

DOUGH RETARDING PANS

- 18 gauge aluminum
- Pans: 7½" x 2½"

Pans

Item #482738

Mfg. #DP800

Cs Pk 12 x 1 ea

Cs Wt 8.25 lb

Cover

Item #482733

Mfg. #DC8

Cs Pk 12 x 1 ea

Cs Wt 8.25 lb

Sold in case pack or eaches.



ALLIED

PIZZA PANS

Aluminum pizza pans are available in several different types of aluminum, but it's best to buy high quality hard-anodized pans. Another key feature to look for is holes in the pan. This allows the crust to become crispy as it cooks. Aluminum pizza pans work best with hand-tossed and thin crusts. A pizza screen allows air to circulate for a more evenly baked and crispy crust. Deep-dish pizza pans have deep sides, ranging from one to two inches deep. These pans are best suited for making Chicago-style pizza.



PAN RACK

- Chrome plated
- Each shelf holds up to 61 lb
- 11 shelves, 2½" between each
- 12" base x 27½"h

Item #482822

Mfg. #PTR11
Cs Pk 2 x 1 ea
Cs Wt 2.50 lb

Sold in case pack or eaches.

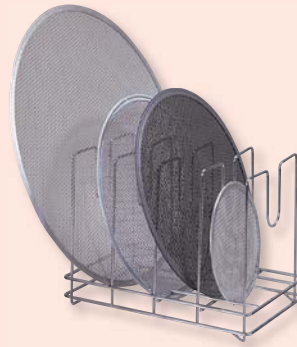

PIZZA SCREEN RACK

- Chrome plated rack
- Holds up to 96 screens

Item #482821

Mfg. #PSR10
Cs Pk 2 x 1 ea
Cs Wt 7.00 lb

Sold in case pack or eaches.

TABLE PIZZA STAND

- Chrome plated
- 6" top x 9" bottom diameter

Item #499912

Mfg. #RTS694
Cs Pk 12 x 1 ea
Cs Wt 6.00 lb

Sold in case pack or eaches.

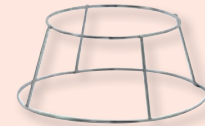

PAN GRIPPERS

- Rugged steel pan grippers for use with deep or shallow pizza pans
- 8"

For Deep Pans

Item #476392

Mfg. #PGRIP(D)
Cs Pk 6 x 1 ea
Cs Wt 3.00 lb

Sold in case pack or eaches.



For Shallow Pans

Item #476393

Mfg. #PGRIP(S)
Cs Pk 6 x 1 ea
Cs Wt 3.00 lb

Sold in case pack or eaches.

PIZZA TRAY RACK

- 15 separate removable shelves
- Accommodates deep pans

Item #481089

Mfg. #PTR-15
Cs Pk 1 x 1 ea
Cs Wt 8.00 lb



KITCHEN

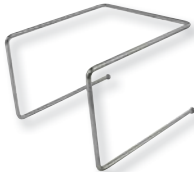

PIZZA TRAY STAND

- Chrome-plated steel rod design is exceptionally strong
- 9"l x 8"w x 7"h

Item #476410

Mfg. #PTS-9
Cs Pk 12 x 1 ea
Cs Wt 14.50 lb

Sold in case pack or eaches.

PIZZA BUBBLE POPPERS

- Stainless steel
- Cs Pk 12 x 1 ea
- Cs Wt 6.00 lb

Item #

482811

Mfg. #

POP1

Description

30" long

482812

POP43

43" long

Sold in case pack or eaches.

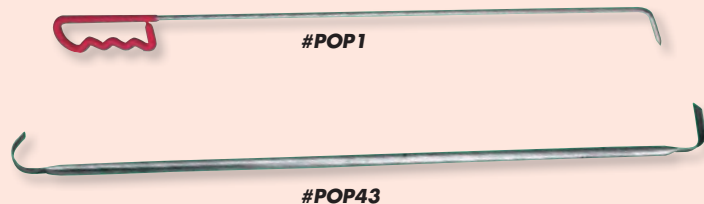

ROLLER DOCKERS

- Heavy duty
- Cs Pk 1 x 1 ea

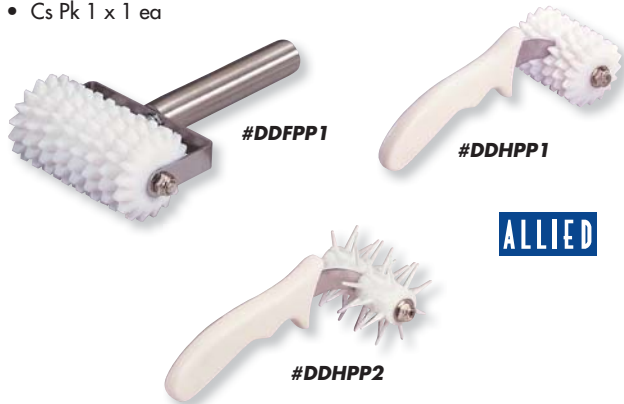

ALLIED

Item #	Mfg. #	Description	Cs Wt
Full size: aluminum handle			
482734	DDFPP1	4 $\frac{7}{8}$ "w x 8 $\frac{1}{4}$ " OA	1.25 lb
Half size: plastic handle			
482736	DDHPP1	3 $\frac{1}{2}$ "w x 8 $\frac{1}{2}$ " OA	0.75 lb
Long Pin: plastic handle			
482737	DDHPP2	3 $\frac{1}{2}$ "w x 8 $\frac{3}{4}$ " OA 7 $\frac{1}{8}$ " Plastic Pins	0.63 lb

ROLLER DOCKER

- Stainless steel handle
- 3/8" pins secured into plastic
- 5" w plastic barrel

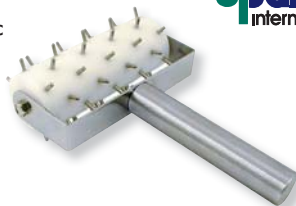

update
international

Item #481090
Mfg. #RD-5
Cs Pk 1 x 1 ea
Cs Wt 1.19 lb



PIZZA KNIVES

ALLIED

- Stainless steel
- Cs Pk 1 x 1 ea

Item #	Mfg. #	Description	Cs Wt
482809	PKO16	16" Blade	1.00 lb
482810	PKR20	20" Blade	1.00 lb

DOUGH CUTTER

ALLIED

- 4 $\frac{1}{2}$ " blade
- Stainless steel blade
- Wood handle
- Made in USA

Item #482695
Mfg. #CG1
Cs Pk 12 x 1 ea
Cs Wt 4.50 lb
Sold in case pack or eaches.



DOUGH CUTTERS

NSF

- 6" x 3" blade

Sani-Safe® Handle
Item #437813
Mfg. #S196PCP
Cs Pk 6 x 1 ea
Cs Wt 2.38 lb
Sold in case pack or eaches.



DEXTER
THE EDGE SINCE 1818



Rosewood Handle/Brass Rivets
Item #393312
Mfg. #S496
Cs Pk 6 x 1 ea
Cs Wt 2.50 lb
Sold in case pack or eaches.



#S160-16



#S160-18 with S161

PIZZA KNIVES

- Sani-Safe® handles
- Cs Pk 6 x 1 ea

DEXTER
THE EDGE SINCE 1818

NSF

Item #	Mfg. #	Description	Cs Wt
393397	S160-16	16" Blade	7.00 lb
393401	S160-18	18" Blade	7.63 lb
393405	S161	4" Guard Attachment	1.75 lb

Sold in case pack or eaches.



PIZZA CUTTERS



- Built to be both tough and sanitary

Item #	Mfg. #	Description	Cs Pk	Cs Wt
Sani-Safe®				
393320	S3A-PCP	2¾" dia, Alum. Handle	12 x 1 ea	4.50 lb
393364	P3A-PCP	2¾" dia, White Handle	6 x 1 ea	2.00 lb
447008	P177A-PCP	4" dia, White Handle	6 x 1 ea	2.75 lb
Basics®				
447745	P94ZZA-4	4" dia, Black Handle	12 x 1 ea	4.25 lb

Sold in case pack or eaches.

WOOD HANDLE PIZZA CUTTER



- Stainless steel cutting wheel with rust proof guard
- 4" diameter wheel

Item #476386
Mfg. #PC-4WH
Cs Pk 12 x 1 ea
Cs Wt 5.50 lb
Sold in case pack or eaches.



PLASTIC HANDLE PIZZA CUTTER



- Stainless steel cutting wheel with easy grip ABS brown bakelite handle
- 4" diameter wheel

Item #476385
Mfg. #PC-4
Cs Pk 12 x 1 ea
Cs Wt 4.69 lb
Sold in case pack or eaches.



PIZZA CUTTERS

- Heavy duty with sure grip feature and finger guard
- 2½" diameter wheel
- Stainless steel blade, aluminum handle
- Made in USA

Item #482679
Mfg. #APC2
Cs Pk 12 x 1 ea
Cs Wt 2.25 lb
Sold in case pack or eaches.



PIZZA/PIE SERVER

- Stainless steel with wood handle

Item #489258
Mfg. #242
Cs Pk 1 x 12 ea
Cs Wt 2.20 lb
Sold in case pack only.



PIE SERVER

- Stainless steel blade, wood handle
- Brass rivets
- 10¼" long, 6" x 2" blade

Item #476447
Mfg. #WPS-6
Cs Pk 12 x 1 ea
Cs Wt 2.30 lb
Sold in case pack or eaches.



#S174PCP



#S176

PIZZA/PIE SERVERS



- Sani-Safe® handles
- Cs Pk 6 x 1 ea

Item #	Mfg. #	Description	Cs Wt
437683	S174PCP	4½" x 2¼" Blade	1.00 lb
393406	S176	6" x 5" Blade	2.88 lb

Sold in case pack or eaches.

PIZZA/PIE SERVER

- 4½" long blade
- Rosewood handle

Item #435453
Mfg. #S244PCP
Cs Pk 6 x 1 ea
Cs Wt 1.25 lb
Sold in case pack or eaches.



ADJUSTABLE STAINLESS DOUGH WHEEL

- Adjusts to popular sizes
- 6 wheels - 2" diameter



Item #482752
Mfg. #MDC6SET
Cs Pk 12 x 1 ea
Cs Wt 12.00 lb
Sold in case pack or eaches.

KITCHEN



PIZZA DOUGH BOX & COVER

- Prevents crusting, allows you to reduce the frequency of dough making, and increases the storage life of your dough
- Stacks securely, loaded or unloaded, and will also stack with other brands
- Rigid polycarbonate construction is reinforced on all sides with rounded edges for safety
- Won't break, bend, sag or lose shape
- Dishwasher safe
- Color: White
- 18" w x 26" d
- Cs Pk 6 x 1 ea



Item #	Mfg. #	Description	Cs	Pk	Cs Wt
393072	DB18263CW-148	Box, 3" deep	24.03	lb	
393063	DBC1826CW-148	Lid	15.00	lb	

Sold in case pack or eaches.

DOUGH BOX

- Now more durable
- Plastic
- 18½" x 26"



Item #	Mfg. #	Description	Cs	Pk	Cs Wt
538938	PL-3	Box, 3" deep	6	x 1 ea	21.16 lb
538939	PL-36C	Cover for PL-3, PL-6	12	x 1 ea	25.57 lb

Sold in case pack or eaches.

KITCHEN

PIZZA DELIVERY BAGS

- Cloth covered outside with an attractive, yet durable material
- Cleans easily, long lasting and tough
- The best industrial pizza bag made today
- Insulated with 1" foam padding and lined with extra tough water repellent nylon
- Contains side grommets to allow excessive moisture to escape
- Includes outer identification pocket
- Color: Maroon



#TPB24-MRN



#TPB20-MRN



#TPB20-12-MRN

Item #	Mfg. #	Description	Cs	Pk	Cs Wt
379555	TPB20-MRN	20" x 20" x 5"	8	x 1 ea	26.00 lb
430052	TPB20-12-MRN	20" x 20" x 12"	6	x 1 ea	33.00 lb
379557	TPB24-MRN	24" x 24" x 5"	8	x 1 ea	34.00 lb

Sold in case pack or eaches.



INSULATED FOOD CARRIER

- Cloth covered outside with an attractive, yet durable material
- Cleans easily, long lasting and tough
- Includes outside identity pocket
- Features 2 padded handles for comfortable carrying
- Coated nylon fabric lining with insulated 1" foam padding
- Zipper closure
- 20" x 12" x 12"
- Color: Maroon

Item #452020
Mfg. #FC2212-MRN
Cs Pk 1 x 1 ea
Cs Wt 3.75 lb



PIZZA BOX SUPPORT

- Eliminates box from collapsing on pizza
- Plastic

Item #425878
Mfg. #20431
Cs Pk 10/100 ea
Cs Wt 5.00 lb

Sold in case pack only.



INSULATED PIZZA DELIVERY BAG

- Fits (2) 18" pizzas
- Includes outer identification pocket
- Dimensions 20" x 20"



Item #483909
Mfg. #PIB-20
Cs Pk 6 x 1 ea
Cs Wt 17.00 lb

Sold in case pack or eaches.



TERRY CLOTH POT HOLDER

- Industrial grade terry
- Machine washable
- Protects to 500°F (intermittent use)
- 8" x 8"
- Color: Brown

Item #379535
Mfg. #802TPH
Cs Pk 24 x 1 dz
Cs Wt 25.00 lb
Sold in case pack or dozens.



JUNIOR PAN GRABBER

- Contains an inner steam barrier
- Protects up to 350°F
- Canvas pouch pocket provides for easy on/off usage
- 6" x 8"

Item #398035
Mfg. #845PG
Cs Pk 24 x 1 dz
Cs Wt 38.00 lb
Sold in case pack or dozens.



PAN GRABBER

- Baker's pad with wrist strap
- Contains inner steam barrier and insulated padding
- Protects up to 400°F
- 9½" x 11"

Item #379546
Mfg. #803PG
Cs Pk 12 x 1 dz
Cs Wt 32.00 lb
Sold in case pack or dozens.



PAN GRABBER

- Machine washable
- Contains a double thick layer of heavyweight terry cloth
- Protects to 500°F (intermittent use)
- 10" x 11"

Item #431478
Mfg. #823TPH
Cs Pk 12 x 1 dz
Cs Wt 32.00 lb
Sold in case pack or dozens.



BESTAN® POT HOLDER

- Tan non-stick quilted Bestan® coating
- A wonderful value
- Protects to 350°F (intermittent use)
- 7" x 7"

Item #398033
Mfg. #812TPH
Cs Pk 24 x 1 dz
Cs Wt 25.00 lb
Sold in case pack or dozens.



SILICONE POT HOLDER

- Non-stick silicone coating
- Protects to 350°F (intermittent use)
- 7" x 7"
- Color: Silver

Item #379543
Mfg. #802SPH
Cs Pk 24 x 1 dz
Cs Wt 25.00 lb
Sold in case pack or dozens.



PAN GRABBER

- Terry outer, 100% cotton fill
- Steam barrier insulates to 450°F
- Wrist strap keeps protection close while freeing hands
- Machine washable
- 8" x 11"

Item #423350
Mfg. #CLPG1
Cs Pk 1 x 12 ea
Cs Wt 3.00 lb
Sold in case pack only.



TERRY POT HOLDER

- Terry outer, 100% cotton fill
- Insulates up to 450°F
- Machine washable
- Color: Black, 8" square

Item #423351
Mfg. #CLTPH8BK
Cs Pk 1 x 12 pr
Cs Wt 3.00 lb
Sold in case pack only.



HANDLE HOLDERS

- BestGuard® quilted insulated interior – Best Guard lined
- Protects to 425°F • 3" x 6½" • Color: Tan

Item #379532
Mfg. #804BG
Cs Pk 12 x 1 dz
Cs Wt 19.00 lb
Sold in case pack or dozens.



KOOL-TEK® PUPPET MITT WITH KEVLAR®

- Resistant to flames and flashes, 100% non-combustible
- Nomex® outer shell, thermal insulation stops thermal transfer even when outer layer is wet
- Kevlar® grip • 12" long

Item #445406

Mfg. #KT0112K

Cs Pk 1 x 1 ea

Cs Wt 1.00 lb

Sold in case pack only.



SAN JAMAR
Smart → Safe → Sanitary

SILICONE OVEN/FREEZER MITT

- Insulates up to 350°F
- Perfect for handling frozen foods
- Resists scorching
- Wipes clean with damp cloth
- Soft and flexible
- 16" long

**Arden™
Benhar**
Foodservice & Institutional



Item #458975

Mfg. #CLOMS26SL

Cs Pk 1 x 12 pr

Cs Wt 11.00 lb

Sold in case pack only.

SILICONE OVEN/FREEZER MITTS

- Non-stick coating
- Great for hot or cold surfaces
- Protects to 400°F
- One size fits all
- Color: Silver
- Cs Pk 72 pr x 1 pr



CREWWARE™
TOOLS YOU CAN TRUST

Item #	Mfg. #	Description	Cs Wt
379526	801SG15	15" long	27.00 lb
379529	801SG17	17" long	32.00 lb

Sold in case pack or pairs.

PYROTEX® OVEN MITTS

- Insulates to 450°F
- Resists scorching
- Wipes clean with damp cloth
- Color: Beige



**Arden™
Benhar**
Foodservice & Institutional

15" Long

Item #423346

Mfg. #CL2PX25BETF

Cs Pk 1 x 12 pr

Cs Wt 6.00 lb

Sold in case pack only.

17" Long

Item #423347

Mfg. #CL2PX27BETF

Cs Pk 1 x 12 pr

Cs Wt 8.80 lb

Sold in case pack only.

CREWWARE™
TOOLS YOU CAN TRUST



BESTAN® OVEN MITTS

- Non-stick Bestan® coating
- Excellent value
- Protects to 400°F
- One size fits all
- Color: Tan
- Cs Pk 72 pr x 1 pr

Item #	Mfg. #	Description	Cs Wt
379520	811TG13	13" long	25.00 lb
379522	811TG17	17" long	32.00 lb

Sold in case pack or pairs.



CREWWARE™
TOOLS YOU CAN TRUST

BESTGUARD® OVEN MITTS

- The ultimate in heat protection – fire-retardant
- Protects to 450°F
- WebGuard™ for extra comfort and protection
- Wipes clean with a damp cloth
- One size fits all
- Cs Pk 72 x 1 pr

Item #	Mfg. #	Description	Cs Wt
398018	800FG13	13" long, Tan	35.00 lb
379512	800FG15	15" long, Tan	38.00 lb
398021	800FG15-BK	15" long, Black	38.00 lb
379518	800FG17	17" long, Tan	48.00 lb
398028	800FG17-BK	17" long, Black	48.00 lb

Sold in case pack or pairs.

TERRY OVEN MITTS

- Heavy-duty institutional grade terry cloth
- Can handle temperatures up to 500°F for short periods of time
- Machine washable
- Color: Natural



Item #	Mfg. #	Description	Cs Pk	Cs Wt
398034	824TM	24" long	36 x 1 pr	42.00 lb
431477	817TM	17" long	48 x 1 pr	40.00 lb

Sold in case pack or pairs.

PROFESSIONAL APRONS



- Poly/cotton blend fabric
- Colorfast – includes matching color, non-tangle ties
- 3-compartment front pockets

Bib Aprons

- 28" x 25"
- Cs Pk 3 x 1 dz
- Cs Wt 14.00 lb

Item #	Mfg. #	Color
379487	602BAFH-BKDZ	Black
379488	602BAFH-BGDZ	Burgundy
379490	602BAFH-NVDZ	Navy Blue
379496	602BAFH-RDDZ	Red
379499	602BAFH-HGDZ	Hunter Green
431512	602BAFH-RBDZ	Royal Blue

Sold in case pack or dozens.

#602BAFH-NV



Waist Aprons

- 23" x 12"
- Cs Pk 3 x 1 dz
- Cs Wt 9.00 lb

Item #	Mfg. #	Color
379477	605WAFH-BKDZ	Black
379481	605WAFH-BGDZ	Burgundy
379482	605WAFH-NVDZ	Navy Blue
379483	605WAFH-RDDZ	Red
379485	605WAFH-HGDZ	Hunter Green

Sold in case pack or dozens.



FULL LENGTH BIB APRONS

- 8" x 8" side pocket
- Poly/cotton blend fabric
- Colorfast with matching non-tangle, colored ties
- 28" x 34"
- Cs Pk 3 x 1 dz
- Cs Wt 14.00 lb

Item #	Mfg. #	Description
398010	601BAC-BGDZ	Burgundy
398011	601BAC-BKDZ	Black
398012	601BAC-GNDZ	Kelly Green
398013	601BAC-NVDZ	Navy Blue
398014	601BAC-RDDZ	Red
431513	601BAC-RBDZ	Royal Blue

Sold in case pack or dozens.



Black Burgundy Red



Kelly Green Navy Blue Hunter Green Royal Blue



BISTRO APRON

- Made from poly/cotton blend fabric
- Extra long self ties
- 28" x 34"
- 2 middle pockets
- Color: Black

Item #431482

Mfg. #607BA2-BKDZ
Cs Pk 1 x 1 dz
Cs Wt 12.00 lb

Sold in case pack only.



4-WAY APRON

- Blended poly/cotton, permanent press
- 34" x 17"
- Color: White

Item #379507

Mfg. #603FWDZ
Cs Pk 5 x 1 dz
Cs Wt 28.00 lb

Sold in case pack or dozens.



BIB APRON

- Poly/cotton blend fabric
- Pencil pocket
- 34" x 34"
- Color: White

Item #379509

Mfg. #600BAWDZ
Cs Pk 5 x 1 dz
Cs Wt 27.00 lb

Sold in case pack or dozens.



DELUXE BIB APRON

- Poly/cotton blend fabric
- Durable 1/2" nylon braid waist ties
- Pencil pocket • 34" x 34"
- Color: White

Item #398043

Mfg. #600BAW-DDZ
Cs Pk 5 x 1 dz
Cs Wt 27.00 lb

Sold in case pack or dozens.

DOUBLE BREASTED CHEF COATS

- Poly/cotton blend
- Breast pocket
- Thermometer pocket on sleeve
- Clear pearl buttons
- Color: White
- Cs Pk 12 x 1 ea
- Cs Wt 18.00 lb



Item #	Mfg. #	Description
379451	J100-M	Medium
379570	J100-L	Large
379572	J100-XL	Extra-Large

Sold in case pack or eaches.



COOK SHIRTS

- Lightweight poly/cotton blend fabric
- Breast pocket and snap closure
- Color: White
- Cs Pk 12 x 1 ea
- Cs Wt 8.05 lb

Item #	Mfg. #	Description
379596	CS006WH-M	Medium
379598	CS006WH-L	Large
486902	CS006WH-XL	Extra-Large

Sold in case pack or eaches.

BAGGY STYLE CHEF PANTS

- Poly/cotton blend
- Elastic waistband
- Two side pockets
- Two hip patch pockets
- Cs Pk 1 x 1 ea
- Cs Wt 2.00 lb



Hounds Tooth

Item #	Mfg. #	Size
486779	PO20HT-M	Medium
486778	PO20HT-L	Large



Black

Item #	Mfg. #	Description
432200	PO20BK-M	Medium
431483	PO20BK-L	Large
431484	PO20BK-XL	X-Large



CHEF COATS

- Double-breasted, 10-button style
- Bar-tacked at stress points
- Machine washable
- 65/35 poly/cotton
- Plastic buttons
- Color: White
- Cs Pk 6 x 1 ea



Item #	Mfg. #	Description	Cs Wt
430136	CLCOATSM	Small	7.00 lb
430137	CLCOATMM	Medium	7.00 lb
430138	CLCOATLG	Large	7.00 lb
430139	CLCOAT1X	X-Large	8.00 lb
430140	CLCOAT2X	XX-Large	8.00 lb

Sold in case pack or eaches.

COOKS SHIRT

- Short sleeves
- Snap-front closing
- 1 upper pocket
- Machine washable
- Plastic buttons
- Color: White
- Cs Pk 6 x 1 ea



Item #	Mfg. #	Description	Cs Wt
430147	CLSHIRTSM	Small	4.00 lb
430149	CLSHIRTMM	Medium	5.00 lb
430150	CLSHIRTLG	Large	5.00 lb
430151	CLSHIRT1X	X-Large	5.00 lb

Sold in case pack or eaches.

BIB APRONS

- Durable, easy-care 65/35 poly/cotton
- Resists wrinkles and shrinkage
- Machine washable
- Pencil/thermometer pocket
- One size fits all, 34" w x 32" l
- Color: White

Item #423354

Mfg. #CLBIAWH

Cs Pk 1 x 1 dz

Cs Wt 5.00 lb

Sold in case pack only.



- 50/50 poly/cotton fabric
- Adjustable "O"-ring neck strap
- Reinforced bias trim, rounded corners
- 2 pockets
- Size: 34" w x 32" l
- Color: White

Item #423355

Mfg. #CL2PBIAWH

Cs Pk 1 x 1 dz

Cs Wt 5.50 lb

Sold in case pack only.

VINYL BIB APRONS

- Vinyl, adjustable neck
- Tubular-nylon ties easily adjust
- Wipes clean with damp cloth
- Size: 26" w x 28" l
- Color: Brown

Item #423365

Mfg. #CLVA

Cs Pk 1 x 1 dz

Cs Wt 6.50 lb

Sold in case pack only.



- Over-sized, long, lightweight vinyl
- Ideal for messy conditions
- Bib front style protects clothing from neck to lower legs
- Size: 34" w x 47" l
- Color: Clear

Item #423366

Mfg. #CLOSVA

Cs Pk 1 x 1 dz

Cs Wt 8.37 lb

Sold in case pack only.



DURASERVE® WAIST APRON

- 4 pocket waist apron (3 pockets and pen pocket)
- 50/50 poly/cotton
- Colorfast
- Machine washable
- 25" x 11"
- Color: Black

Item #423367

Mfg. #CL3PWACBK

Cs Pk 1 x 12 ea

Cs Wt 3.50 lb

Sold in case pack only.

Individually packaged

for Cash & Carry.



DURASERVE® BIB APRONS

- 3 pocket bib apron made of fade resistant duraSERVE® fabric
- Pen pocket • Adjustable neck
- Size: 26" w x 23" l
- Cs Pk 1 x 1 dz
- Cs Wt 5.50 lb

Item #	Mfg. #	Description
423357	CL3PBIABKFP	Black
423356	CL3PBIABGFP	Burgundy
423359	CL3PBIAHGFP	Hunter Green
423360	CL3PBIANVFP	Navy
423361	CL3PBIARDFP	Red



KITCHEN

TEXTILE TIPS

A well-dressed employee sends a message to your customers that you care about their entire dining experience. Maintain a stock of back-up aprons, jackets, shirts, etc. If a food handling mishap occurs your employees will always look fresh and clean. Aprons made of a poly-cotton blend are designed for easy care with less shrinkage, wrinkling and fading. Train employees to properly wash their hands, and never to use their aprons or wiping cloths to dry their hands or face! Protective flame retardant mitts and pot holders can be used for more than just pulling hot foods out of the oven. Use while deep frying, candy making, moving foods from freezer to oven and handling dry ice – wherever you need protection from extreme temperatures!

CHEF HATS

- Machine washable
- Adjustable
- One size fits all
- Color: White



13" open weave
Item #430133
 Mfg. #CLCH3
 Cs Pk 12 x 1 ea
 Cs Wt 2.00 lb
Sold in case pack or eaches.

13" closed weave
Item #430135
 Mfg. #CLCH3D
 Cs Pk 12 x 1 ea
 Cs Wt 2.00 lb
Sold in case pack or eaches.

BASEBALL STYLE KITCHEN CAP

- Machine washable
- Adjustable
- One size fits all
- Color: Houndstooth Check

Item #430134
 Mfg. #CLHTBBC
 Cs Pk 12 x 1 ea
 Cs Wt 5.00 lb
Sold in case pack or eaches.



BAR MOP TOWEL

- Heavy ribbed, terry
- 100% cotton
- 24 oz, 16" x 19"
- Conveniently packaged



Item #428350
 Mfg. #CLBMR
 Cs Pk 12 x 1 dz
 Cs Wt 24.00 lb
Sold in case pack or dozens.



HERRINGBONE TOWELS

- Striped heavyweight 100% cotton
- Smooth, non-linting properties make it ideal for polishing
- Very absorbent



15" x 26" long
Item #379447
 Mfg. #703HB
 Cs Pk 12 x 1 dz
 Cs Wt 20.00 lb
Sold in case pack or dozens.

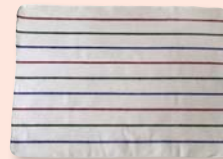

20" x 28" long
Item #398016
 Mfg. #703HB28
 Cs Pk 12 x 1 dz
 Cs Wt 28.00 lb
Sold in case pack or dozens.

MULTI-STRIPE TOWEL

- 100% cotton terry cloth
- Assorted designer stripes
- 15" x 26"



Item #379446
 Mfg. #705MSK
 Cs Pk 12 x 1 dz
 Cs Wt 23.00 lb
Sold in case pack or dozens.

KITCHEN

CHEF HAT

- Poly/cotton blend
- 13" tall
- Color: White

Item #379450
 Mfg. #H400WH
 Cs Pk 48 x 1 ea
 Cs Wt 10.00 lb
Sold in case pack or eaches.



BAR MOP TOWELS

- Made from 100% high grade absorbent cotton
- 16" x 19"



Narrow Ribbed,
 24 oz/dz
Item #398015
 Mfg. #700BRT24
 Cs Pk 12 x 1 dz
 Cs Wt 20.00 lb

Narrow Ribbed,
 28 oz/dz
Item #379560
 Mfg. #700BRT28
 Cs Pk 12 x 1 dz
 Cs Wt 23.00 lb

Full Terry, 30 oz/dz
Item #379445
 Mfg. #701BTT30
 Cs Pk 12 x 1 dz
 Cs Wt 25.00 lb



Sold in case pack or dozens.



FLOUR SACK TOWEL

- 100% cotton flour sack material
- 22" x 37"

Item #379449
 Mfg. #704FSTW
 Cs Pk 12 x 1 dz
 Cs Wt 22.00 lb
Sold in case pack or dozens.



WAFFLE-WEAVE DISH CLOTH

- Assorted designer colors
- 100% cotton
- 13" x 15"

Item #379448

Mfg. #706DC
Cs Pk 12 x 1 dz
Cs Wt 15.00 lb

Sold in case pack or dozens.



CHEESECLOTH

- High grade
- 100% lintless cotton

Item #431602

Mfg. #G10-R
Grade 10, 4 sq yds/pkg.
Cs Pk 1 x 50 ea
Cs Wt 20.00 lb

Sold in case pack only.



#G10-R



#G10



Item #379551

Mfg. #G10
Grade 10, 36" x 80 yds
Cs Pk 10 x 1 bx
Cs Wt 40.00 lb

Sold in case pack or boxes.

Item #398037

Mfg. #G40-R
Grade 40, 4 sq yds/pkg.
Cs Pk 10 x 1 ea
Cs Wt 50.00 lb

Sold in case pack or eaches.

CHEESECLOTH

- Fine mesh for straining, wrapping or covering
- 20/12 80 yards

Item #436551

Mfg. #CH201280-10P
Cs Pk 1/10 ct
Cs Wt 35.00 lb

Sold in case pack only.

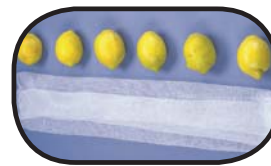

VINYL BIB APRON

- Heavyweight naugahyde leather-look vinyl on cotton knit backing
- Waterproof and fire-retardant
- 25" x 28"
- Color: Brown

Item #379505

Mfg. #604VBA-BR
Cs Pk 36 x 1 ea
Cs Wt 26.00 lb

Sold in case pack or eaches.



KITCHEN

NITRILE DISHWASHING GLOVES

- Super tough, flexible & extremely heat-resistant nitrile rubber
- Unlined, 19" long, elbow length
- USDA accepted
- Color: Green, 25 mil thickness
- Stocked in L - large, M - medium
- Cs Pk 12 x 1 pr • Cs Wt 8.04 lb

Item # Mfg. #

398040 19NU-L

486034 19NU-M

Sold in case pack or pairs.



VINYL DISHWASHING APRON

- Institutional (commercial) quality vinyl
- Includes heavy duty braided ties
- 36" x 43"
- Color: Clear

Item #379503

Mfg. #614DVADZ
Cs Pk 4 x 1 dz
Cs Wt 39.00 lb

Sold in case pack or dozens. Stocked in clear only.

PVC POT & SINK GLOVES

- Inside has a cotton interlock lining for additional protection
- Possesses a "rough grip" construction for improved handling
- One size fits all • Protects to 185°F

14" long

Item #497872

Mfg. #884

Cs Pk 48 x 1 pr

Cs Wt 39.00 lb

18" long (elbow length)

Item #379548

Mfg. #887

Cs Pk 36 x 1 pr

Cs Wt 35.00 lb

Sold in case pack or pairs.



Shown with optional extenders.



#255534-151
Stocked in soft gray only.



#165418-151



#95638-151
Stocked in soft gray only.

CAMBRO
TRUSTED FOR GENERATIONS™



#365418-151

CAMRACKS® WAREWASHING & STORAGE SYSTEM

- Unique close walled design and protective splash guard ensure your glassware and dishes are cleaned completely
- Create a self-contained, portable storage system by stacking filled Camracks® on a dolly
- Easy grip handles for comfortable, safe handling and lifting
- Color: Soft Gray (151)



#16C258-151



#10HC414-151
Shown with optional extenders.

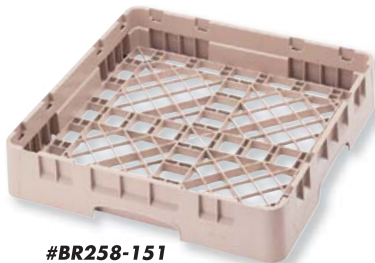

#BR258-151
Stocked in soft gray only.

Item #	Mfg. #	Overall Dimensions	Comp. Size	Cs Pk	Cs Wt
Glass Rack - 9 Compartments					
458177	9S638-151	19¾" x 19¾" x 8⅞"	5⅞" square x 6⅞"h	3 x 1 ea	27.14 lb
Glass Rack - 16 Compartments					
458178	16S418-151	19¾" x 19¾" x 5⅞"	4⅞" square x 4½"h	5 x 1 ea	29.00 lb
432222	16S534-151	19¾" x 19¾" x 7¼"	4⅞" square x 6⅞"h	4 x 1 ea	30.15 lb
458174	16S738-151	19¾" x 19¾" x 8⅞"	4⅞" square x 7¾"h	3 x 1 ea	27.80 lb
458145	16S800-151	19¾" x 19¾" x 10½"	4⅞" square x 8½"h	2 x 1 ea	21.62 lb
Glass Rack - 25 Compartments					
458674	25S418-151	19¾" x 19¾" x 5⅞"	3½" square x 4½"h	5 x 1 ea	30.40 lb
458151	25S534-151	19¾" x 19¾" x 7¼"	3½" square x 6⅞"h	4 x 1 ea	28.90 lb
432227	25S738-151	19¾" x 19¾" x 8⅞"	3½" square x 7¾"h	3 x 1 ea	27.34 lb
Glass Rack - 36 Compartments					
458152	36S418-151	19¾" x 19¾" x 5⅞"	2⅞" square x 4½"h	5 x 1 ea	32.09 lb
458147	36S534-151	19¾" x 19¾" x 7¼"	2⅞" square x 6⅞"h	4 x 1 ea	33.74 lb
Full Size Cup Rack - 16 Compartments					
• Unique tilt feature drains water from cup and mug bases					
389256	16C258-151	19¾" x 19¾" x 4"	4⅞" square x 2⅞"h	6 x 1 ea	28.79 lb
Half Size Cup Rack - 10 Compartments					
• Unique tilt feature drains water from cup and mug bases					
389255	10HC258-151	19¾" x 9⅞" x 4"	4⅞" x 3½" x 2⅞"h	6 x 1 ea	16.46 lb
Full Size Base Rack					
389252	BR258-151	19¾" x 19¾" x 4"	18" square x 2⅞"h	6 x 1 ea	21.73 lb
Full Size Flatware Rack					
389253	FR258-151	19¾" x 19¾" x 4"	18" square x 2⅞"h	6 x 1 ea	24.51 lb
Full Size Dish Rack					
• Designed for easy loading and stable positioning					
389254	PR59314-151	19¾" x 19¾" x 4"	18" square x 3¼"h	6 x 1 ea	24.73 lb

Sold in case pack or eaches.



#FR258-151



#PR59314-151



TRAEX®
A Libbey FOODSERVICE Company

RACK-MASTER® FULL-SIZE RACK SYSTEM

- Open profile allows top-to-bottom and side-to-side washing action
- Snap-fit extenders • Racks stack with all domestic competitive racks
- Double wall construction • Handles on all four sides – can enter dishwasher from any side • Overall Dimensions: 19 $\frac{3}{4}$ " x 19 $\frac{3}{4}$ " x 4" • Color: Beige



Item #	Mfg. #	Compartment Size	Cs Pk	Cs Wt
Pot Rack – 1 Extender – Ideal For Cups, Bowls and Large or Irregularly Shaped Items				
429336	TR-1	18 $\frac{1}{8}$ " square x 3 $\frac{1}{4}$ "h	6 x 1 ea	18.99 lb
Flat Rack – 1 Extender – Mesh Surface Keeps Flatware in the Rack				
429337	TR-2	18 $\frac{1}{8}$ " square x 3 $\frac{1}{4}$ "h	6 x 1 ea	22.90 lb
Plate Rack – 1 Extender – Longer Pegs Support Large Plates and Trays				
429338	TR-3	18 $\frac{1}{8}$ " square x 3 $\frac{1}{4}$ "h	6 x 1 ea	27.00 lb
Cup Rack – 16 Compartments – With Tilt Bar for Drainage				
502152	TR-4	4 $\frac{7}{8}$ " square x 3 $\frac{1}{4}$ "h	6 x 1 ea	37.45 lb
Cup Rack – 20 Compartments – With Tilt Bar for Drainage				
429340	TR-5	3 $\frac{1}{32}$ " x 4 $\frac{7}{16}$ " x 3 $\frac{1}{4}$ "h	6 x 1 ea	25.12 lb
Rack-Master® Dolly – High-Density Polyethylene, 5" Casters, Beige				
380782	1697	21" x 21"	1 x 1 ea	13.60 lb

Sold in case pack or eaches.

TRAEX®
A Libbey FOODSERVICE Company

RACK-MASTER® GLASS RACKS

- Color: Beige
- Cs Pk 2 x 1 ea

Item #	Mfg. #	Overall Dimensions	Comp. Size	Cs Wt
Stemware Rack – 25 Compartments – 1 Extender				
457770	TR-6B	19 $\frac{3}{4}$ " x 19 $\frac{3}{4}$ " x 5 $\frac{1}{8}$ "	3 $\frac{1}{32}$ " square x 4 $\frac{1}{16}$ "h	12.50 lb
Stemware Rack – 25 Compartments – 2 TR-B Extenders				
431489	TR-6BB	19 $\frac{3}{4}$ " x 19 $\frac{3}{4}$ " x 7 $\frac{1}{8}$ "	3 $\frac{1}{32}$ " square x 6 $\frac{3}{8}$ "h	15.33 lb
Stemware Rack – 25 Compartments – 3 Extenders				
431493	TR-6BBB	19 $\frac{3}{4}$ " x 19 $\frac{3}{4}$ " x 8 $\frac{3}{4}$ "	3 $\frac{1}{32}$ " square x 7 $\frac{7}{8}$ "h	20.00 lb
Stemware Rack – 25 Compartments – 4 Extenders				
457771*	TR-6BBBB	19 $\frac{3}{4}$ " x 19 $\frac{3}{4}$ " x 10 $\frac{5}{16}$ "	3 $\frac{1}{32}$ " square x 9 $\frac{1}{16}$ "h	23.00 lb
Stemware Rack – 36 Compartments – 3 Extenders				
431494	TR-7CCC	19 $\frac{3}{4}$ " x 19 $\frac{3}{4}$ " x 8 $\frac{3}{4}$ "	2 $\frac{1}{16}$ " square x 7 $\frac{7}{8}$ "h	22.00 lb
Stemware Rack – 16 Compartments – 1 Extender				
457780	TR-8D	19 $\frac{3}{4}$ " x 19 $\frac{3}{4}$ " x 5 $\frac{1}{8}$ "	4 $\frac{7}{16}$ " square x 4 $\frac{1}{16}$ "h	11.50 lb
Stemware Rack – 16 Compartments – 2 TR-D Extenders				
451539	TR-8DD	19 $\frac{3}{4}$ " x 19 $\frac{3}{4}$ " x 7 $\frac{1}{8}$ "	4 $\frac{7}{16}$ " square x 7 $\frac{7}{8}$ "h	15.33 lb
Stemware Rack – 16 Compartments – 3 Extenders				
431495	TR-8DDD	19 $\frac{3}{4}$ " x 19 $\frac{3}{4}$ " x 8 $\frac{3}{4}$ "	4 $\frac{7}{16}$ " square x 7 $\frac{7}{8}$ "h	18.00 lb
Stemware Rack – 16 Compartments – 4 Extenders				
459237	TR-8DDDD	19 $\frac{3}{4}$ " x 19 $\frac{3}{4}$ " x 10 $\frac{5}{16}$ "	4 $\frac{7}{16}$ " square x 9 $\frac{1}{16}$ "h	21.00 lb
Stemware Rack – 49 Compartments – 1 Extender				
457781	TR-9E	19 $\frac{3}{4}$ " x 19 $\frac{3}{4}$ " x 5 $\frac{1}{8}$ "	2 $\frac{1}{2}$ " square x 4 $\frac{1}{16}$ "h	12.05 lb
Glass Rack – 20 Compartments – 2 Extenders				
431492	TR-11GG	19 $\frac{3}{4}$ " x 19 $\frac{3}{4}$ " x 7 $\frac{1}{8}$ "	3 $\frac{1}{16}$ " Hexagon x 6 $\frac{3}{8}$ "h	16.50 lb
Glass Rack – 9 Compartments – 2 Extenders				
457783	TR-10FF	19 $\frac{3}{4}$ " x 19 $\frac{3}{4}$ " x 7 $\frac{1}{8}$ "	6" square x 6 $\frac{3}{8}$ "h	16.00 lb
Glass Rack – 30 Compartments – 2 Extenders				
460086	TR-12HH	19 $\frac{3}{4}$ " x 19 $\frac{3}{4}$ " x 7 $\frac{1}{8}$ "	3 $\frac{3}{16}$ " Hexagon x 6 $\frac{3}{8}$ "h	17.20 lb

Sold in case pack or eaches.

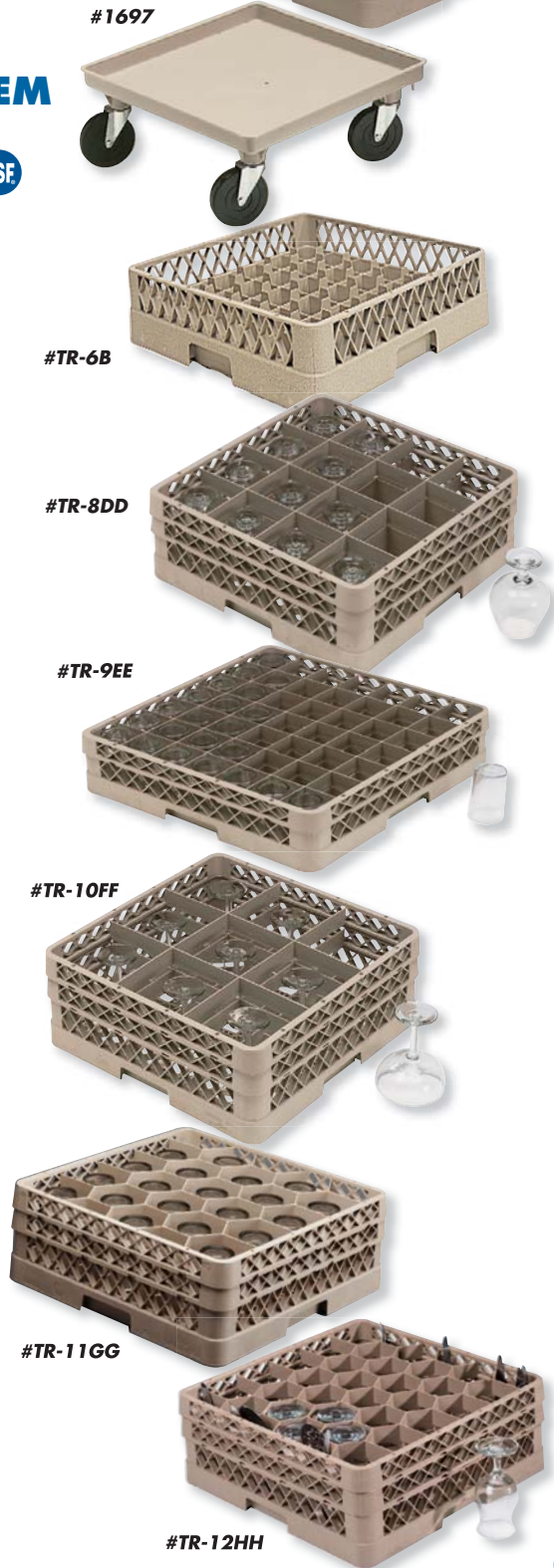

KITCHEN



#TR-D



#TR-G



#TR-B



#TR-A



RACK-MASTER® GLASS & CUP EXTENDER RACKS



- Overall Dimensions: 19¾" x 19¾" x 1⅛"
- Color: Beige
- Cs Pk 12 x 1 ea

Item #	Mfg. #	Comp. Size	Extender	Cs Wt
460083	TR-A	18⅛" square x 1⅛"	Open	10.80 lb
460084	TR-B	31⅞" square x 1⅛"	25 Compartments	21.00 lb
457786	TR-D	4⅞" square x 1⅛"	16 Compartments	19.99 lb
460098	TR-G	31⅞" Hexagon x 1⅛"	20 Compartments	22.60 lb

Sold in case pack or eaches.



RACK MAX® COMBO RACK

- Industry exclusive, the first manufactured combination rack for flatware, china or pitchers
- Comp. Size: 18⅛" square x 3¼"h
- Overall Dimensions: 19" x 19" x 4"
- Color: Beige



Item #460100

Mfg. #TR-15
Cs Pk 6 x 1 ea
Cs Wt 21.39 lb

Sold in case pack or eaches.



RUBBER SCRAP BLOCK

- 6½" diameter x 4" deep

Item #504961

Mfg. #RSB-6
Cs Pk 12 x 1 ea
Cs Wt 3.50 lb

Sold in case pack or eaches.



KATCHALL® SCRAP BLOCK



- Patented design virtually eliminates flatware loss at dish table
- Made of durable, resilient, long-lasting rubber
- Fits all standard dishtable openings (5½" to 7")
- Dishwasher safe, easy to clean
- No moving or exposed parts, no assembly

Item #395926

Mfg. #KA600
Cs Pk 1 x 1 ea
Cs Wt 5.00 lb



KATCHALL® TABLEWARE RETRIEVERS

- Keeps flatware from falling into trash
- Flatware cannot accidentally be pushed off magnetic bar by waste
- Made of rugged, durable plastic
- Dispose of waste normally, no added requirements, no assembly
- Dishwasher safe, easy to clean with pre-rinse or pressure hose
- Cs Pk 1 x 1 ea



#KA3200



#KA3244



#KA4400

Receptacles not included.

Item #	Mfg. #	Description	Cs Wt
395928	KA3200	Fits 32 gal Round	19.00 lb
397616	KA3244	Fits 32 & 44 gal Round	17.00 lb
395929	KA4400	Fits 44 gal Round	19.00 lb

FULL-SIZE RACKS

- Peg corner design provides secure stacking with Vollrath® racks and most competitors' racks
- Open design promotes better washing action, complete rinsing, and faster drying
- Handles are molded into each rack for easy lifting and transport
- Four-way tracking allows for fast dish machine loading in either direction
- Color: Light Green
- Made in USA

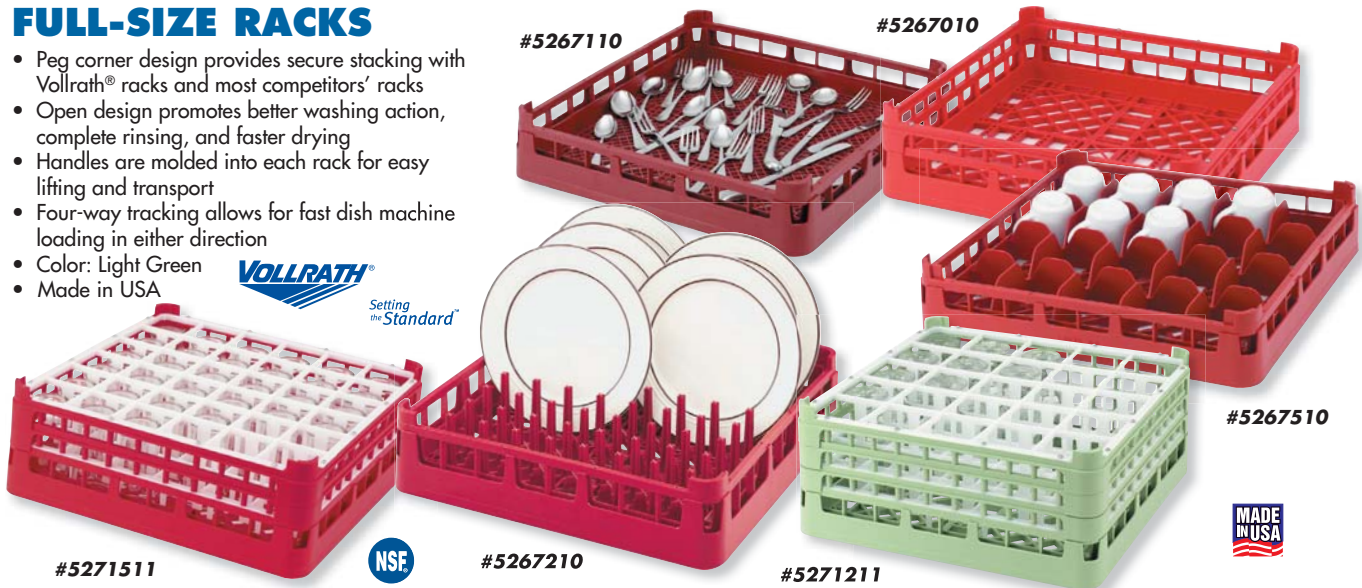

Item #	Mfg. #	Overall Dimensions	Compartment Size	Cs Pk	Cs Wt
Open Rack – Short					
• For unusual shaped or oversized dishes and utensils					
379898	5267010	19¾" x 19¾" x 4½"	18" square x 2⅜" h	6 x 1 ea	18.96 lb
Flatware Rack – Full Size					
• Tight lattice bottom grid allows free-flow of cleaning water while flatware stays firmly in place					
379902	5267110	19¾" x 19¾" x 4½"	18⅛" square x 2½" h	6 x 1 ea	24.30 lb
Plate and Tray Rack – Standard Height					
• Holds plates and trays upright for the ideal cleaning angle					
379905	5267210	19¾" x 19¾" x 3¼"	1⅞" x 18⅞" x 2¼" h	6 x 1 ea	21.84 lb
Plate and Tray Rack – Extended Height					
• Taller pegs and sidewalls accommodate larger plates, added plate lock keeps plates from touching					
379966	5269510	19¾" x 19¾" x 4⅞"	1⅞" x 18⅞" x 3¼" h	5 x 1 ea	25.20 lb
Cup Rack – 16 Compartments, Short					
• Will hold most standard-sized cups					
379908	5267410	19¾" x 19¾" x 4½"	4⅝" square x 2¼" h	6 x 1 ea	24.60 lb
Cup Rack – 16 Compartments, Medium					
• Extra high molded compartments prevent chipping and breaking					
379912	5267611	19¾" x 19¾" x 5⅞"	4⅝" square x 4⅞" h	4 x 1 ea	18.88 lb
Cup Rack – 20 Compartments, Short					
• Will hold most standard-sized cups					
379910	5267510	19¾" x 19¾" x 4½"	3⅞" x 4⅝" x 2⅜" h	6 x 1 ea	29.10 lb
Cup Rack – 20 Compartments, Medium					
• Extra high molded compartments prevent chipping and breaking					
379913	5267711	19¾" x 19¾" x 5½"	3⅞" x 4⅝" x 4⅞" h	4 x 1 ea	21.88 lb
Glass Rack – 25 Compartments, Extra Tall					
379967	5271211	19¾" x 19¾" x 8½"	3½" x 3½" x 4⅝" h	3 x 1 ea	20.16 lb
Glass Rack – 36 Compartments, Tall					
379968	5271511	19¾" x 19¾" x 7"	2⅞" square x 5⅝" h	3 x 1 ea	19.11 lb

Sold in case pack or eaches.



KITCHEN

8-COMPARTMENT FLATWARE BASKET W/HANDLES



- Presort, soak and wash your flatware
- Two baskets fit full-size open rack – nest for compact storage – handles for easy lifting
- 18½" x 13⅞" high
- Compartment size: 3⅞" square x 4¼" high
- Color: Light Green
- Made in USA

Item #379781
Mfg. #52641
Cs Pk 4 x 1 ea
Cs Wt 12.64 lb

Sold in case pack or eaches.

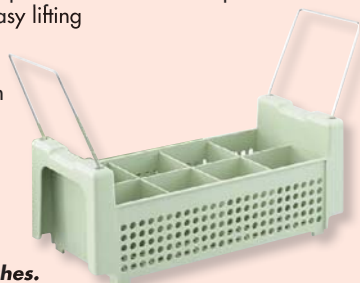

DISH RACK DOLLY

- Provides smooth, safe transport for all full-size racks
- Durable plastic is resistant to rust and corrosion
- 4" non-marking wheels
- Platform dimensions: 20" x 20"
- Weight capacity: 200 lb
- Made in USA
- Cs Pk 1 x 1 ea

Handle sold separately.



Item #	Mfg. #	Description	Cs Wt
412496	52290	Dolly	11.34 lb
370863*	52293	Handle	4.06 lb

* Special Order



GLASS FILLER

- Deck mounted, pedestal type, 9 $\frac{5}{8}$ " tall
- Volume regulator • Instant shut-off
- 1/2" NPT male shank, adjustable flange

Item #476158

Mfg. #B-1210

Cs Pk 1 x 1 ea

Cs Wt 2.76 lb



RELIABILITY BUILT IN™

AB1953
Compliant



REPAIR KIT FOR B-1210 Not Shown

- Includes: 1 adjustable outlet w/hex key, 1 valve assembly w/valve spring and 1 lever arm repair kit w/screw and nut

Item #538941

Mfg. #B-1256

Cs Pk 1 x 1 ea

Cs Wt 0.30 lb

REPAIR KIT FOR GLASS FILLER

- Includes: 2 "O" rings, 2 seat washers, 2 springs, 1 handle screw, 2 stem packings, 1 handle nut, 1 lever arm, 2 bonnet washers, 1 silicone grease tube and 1 blue lexan outlet tip

Item #476162

Mfg. #B-1255

Cs Pk 1 x 1 ea

Cs Wt 0.08 lb



SWIVEL BASE FAUCET

- Wall mounted mixing faucet
- Lever handle
- 8" centers
- 1/2" NPT eccentric flanged female inlets
- 12" swing nozzle w/stream regulator

Item #476160

Mfg. #B-0231

Cs Pk 1 x 1 ea

Cs Wt 5.66 lb



RELIABILITY BUILT IN™

AB1953
Compliant



DOUBLE JOINT NOZZLE

- Nozzle tip has male threads and stream regulator
- 18" length; 12" back, 6" front

Shown with 12" swing nozzle.

Item #476167

Mfg. #068X

Cs Pk 1 x 1 ea

Cs Wt 1.92 lb



RELIABILITY BUILT IN™

AB1953
Compliant



ADD-ON FAUCET FOR PRE-RINSE UNIT

- Adds swinging nozzle to pre-rinse units
- 6" nozzle
- Includes 3" nipple to install on existing base faucets

Item #481534

Mfg. #B-0155

Cs Pk 1 x 1 ea

Cs Wt 3.00 lb



RELIABILITY BUILT IN™

AB1953
Compliant



SWING NOZZLE

- Nozzle tip has male threads and stream regulator
- 3 $\frac{3}{4}$ " clearance
- 12" length

Item #476168

Mfg. #062X

Cs Pk 1 x 1 ea

Cs Wt 0.85 lb



RELIABILITY BUILT IN™

AB1953
Compliant



WORKBOARD FAUCET

- Splash back mounted
- Removable seats
- 10 $\frac{1}{2}$ " long x 2" wide chrome plated escutcheon
- 8" centers
- 1" long shanks
- 1/2" NPT thread
- 10" swing nozzle

Shown with 12" swing nozzle.

Item #476159

Mfg. #B-1127

Cs Pk 1 x 1 ea

Cs Wt 4.25 lb

AB1953
Compliant



RELIABILITY BUILT IN™



WALL MOUNT HAND SINK

- 20 gauge stainless steel • Marine edge
- Bowl is 5" deep, backsplash 9 $\frac{1}{2}$ "
- 4" gooseneck faucet
- Includes drain basket and wall mount clips

Item #483096

Mfg. #WSHS-1410-5-F

Cs Pk 1 x 1 ea

Cs Wt 15.00 lb





EASY INSTALL PRE-RINSE UNIT

- Single hole base faucet with "pop and lock" riser installation feature
- 6" wall bracket
- 18" flexible inlets with 1/2" couplings
- 1/2" NPT male inlets
- Spray valve
- Flexible stainless steel hose
- 45" high
- 14" overhang
- 19 3/8" clearance
- 24" riser

Item #476155
Mfg. #B-0113-B
Cs Pk 1 x 1 ea
Cs Wt 13.00 lb



WALL MOUNT PRE-RINSE UNIT

- 8" center wall mount faucet with "pop and lock" riser installation feature
- 6" wall bracket
- 1/2" NPT female eccentric flanged inlets
- Spray valve
- Flexible stainless steel hose
- 35 1/2" high
- 15" overhang
- 8 1/4" clearance
- 18" riser

Item #476156
Mfg. #B-0133-B
Cs Pk 1 x 1 ea
Cs Wt 12.25 lb

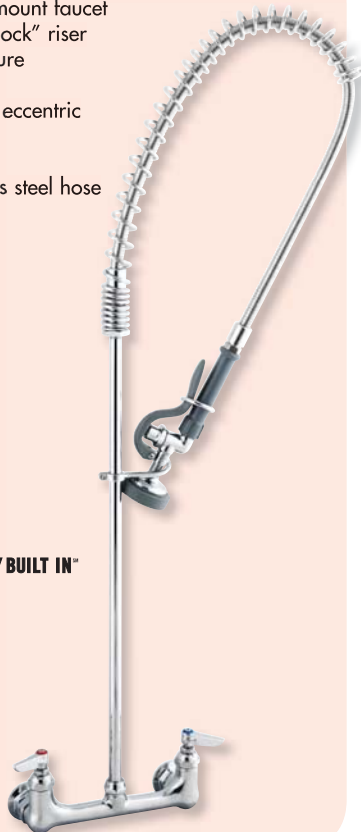

PRE-RINSE PARTS

Spray Valve

- Connects directly to T&S flexible stainless steel hose or handle assembly
- Designed for heavy use in industrial kitchens
- Shuts off when handle is released

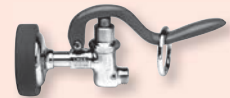

#B-0107

Low Pressure Model

- Fan jet with knife action spray
- Can be used in place of B-0107
- Saves energy
- Cs pk 1 x 1 ea

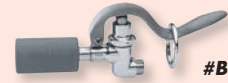

#B-0107-C

#001121-45



#007861-45



Item #	Mfg. #	Description	Cs Wt
476149	B-0107	Spray Valve	1.24 lb
476150	B-0107-C	Low Pressure Spray Valve	1.41 lb
476152	007861-45	Rubber Ring for B-0107	0.10 lb
476153	001121-45	Spray face for B-0107	0.10 lb

Spray Valve Repair Kit

- For B-0107 – spray valve
- Includes: (2) 000895-45 Spring, (2) 000974-45 Bonnet Washer, (2) 010476-45 Hose Washer, (2) 001100-45 Packing Stem, (2) 009306-20 Valve Stem, (2) 001040-45 Bonnet Binding Washer, (2) 012915-45 Seat Washer, (1) 007861-45 Spray Head Ring, (1) 000913-45 Spray Face Screw, (1) 001121-45 Spray Face



Item #476151
Mfg. #B-10K
Cs Pk 1 x 1 ea
Cs Wt 0.10 lb



WALL BRACKET FOR PRE-RINSES

- Fits 3/8" pre-rinse riser
- 6" wall bracket

Item #476157
Mfg. #B-0109-01
Cs Pk 1 x 1 ea
Cs Wt 0.83 lb



BRUSH ATTACHMENT

- High quality nylon bristles
- Fits B-0107 spray valve

Item #476161
Mfg. #BR10
Cs Pk 1 x 1 ea
Cs Wt 0.14 lb



PRE-RINSE HOSE WITH HANDLE

- Flexible stainless steel hose
- 44" overall length
- 3/4" female inlet and outlet
- Polyurethane inner hose

Item #476154
Mfg. #B-0044-H
Cs Pk 1 x 1 ea
Cs Wt 2.00 lb



KITCHEN

VERSA® DISH CADDY

- Holds round or square plates
- Secure, high-capacity storage protects valuable dinnerware
- Durable, polyethylene exterior will not rust, crack dent or chip
- Heavy-duty 3/4" plated steel rear axle supports up to 500 pounds
- Open access for easy loading and unloading
- Molded-in handles on both ends for easy transporting
- 5" front swivel casters with brake and 10" non-marking rear wheels ease maneuvering
- Easy to clean
- Vinyl cover included for sanitary storage
- Color: Black



Item #504135*
Mfg. #DCS1125-110
Cs Pk 1 x 1 ea
Cs Wt 89.00 lb
*** Special Order**



Shown in Speckled Gray

CAMBRO
TRUSTED FOR GENERATIONS™



ADJUSTABLE DISH CADDY

- Store dishes from 4 5/8" to 13" wide
- Six towers adjust easily as needed to set up 4 or 6 columns of dishes
- Columns hold 45-60 plates depending on style, footed or non-footed
- Store one size dish or a combination of different sizes in a single caddy
- 500-lb load capacity
- Front 5" swivel casters with brake and 10" rear wheels
- Molded-in handles on each end
- Vinyl cover included for sanitary storage
- Color: Black



Item #470604*
Mfg. #ADCS-110
Cs Pk 1 x 1 ea
Cs Wt 165.00 lb
*** Special Order**



CUTLERY BINS

- Made of FDA approved, high density polyethylene
- 4 compartments for flatware
- Stackable
- 21" x 12" x 4"



Item #	Mfg. #	Color	Cs Pk	Cs Wt
538145	1524B	Black	12 x 1 ea	20.75 lb
491308	1524G	Grey	12 x 1 ea	20.75 lb

Sold in case pack only.

CUTLERY BIN

- Reinforced ribs and wide rim – stackable
- Gastronorm 12 7/8" x 20 7/8" x 4 1/2"
- Color: Gray

TRAEX®
A LIBBY FOODSERVICE Company



Item #429343
Mfg. #1375-31
Cs Pk 12 x 1 ea
Cs Wt 25.12 lb
Sold in case pack or eaches.

PLASTIC SILV-A-TAINER

- Made of tough plastic that is easy to clean
- Holds 6 cylinders (sold separately)
- 15 1/8" x 10 3/4" x 11"
- Color: Gray

VOLLRATH®
Setting the Standard™



Item #368263
Mfg. #52644
Cs Pk 1 x 1 ea
Cs Wt 2.82 lb

FLATWARE CYLINDER



- Plastic
- Color: White

Item #476346
Mfg. #FLT-CYP
Cs Pk 36 x 1 ea
Cs Wt 7.50 lb
Sold in case pack or eaches.

update
international

PLASTIC CUTLERY CYLINDER

- Fits all Silv-A-Tainers
- 3 3/4" diameter x 5 5/8" h
- Color: White

VOLLRATH®

Setting the Standard™



Item #393060
Mfg. #52643
Cs Pk 12 x 1 ea
Cs Wt 3.36 lb

BUS BOXES

- Stackable, high-density plastic
- Approved for temperatures up to 180°F and as low as -30°F
- 15" x 20"
- Color: Gray

TRAEX®
A LIBBY FOODSERVICE Company



Item #	Mfg. #	Description	Cs Pk	Cs Wt
429342	1520-31	Budget, 5"d	24 x 1 ea	31.50 lb
429344	1521-31	Deluxe, 5"d	12 x 1 ea	25.52 lb
429345	1527-31	Standard, 7"d	12 x 1 ea	24.37 lb
Bus Box Cover - Fits 1520, 1521 & 1527				
486816	1522-31	Cover	12 x 1 ea	16.00 lb

Sold in case pack or eaches.

TOTE BOXES & COVERS

- FDA approved high density polyethylene
- Pebbled finish outside, stackable, reinforced handles



Tote Box

- 7" deep capacity
- 15¼" x 21¼"
- Cs Pk 1 x 1 dz
- Cs Wt 27.60 lb

Item #	Mfg. #	Color
380230	1537G	Gray
380228	1537B	Black
380231	1537W	White
380229	1537BR	Brown

Sold in case pack only.



Tote Box

- 5" deep capacity
- 15¼" x 21¼"
- Cs Pk 1 x 1 dz
- Cs Wt 22.10 lb

Item #	Mfg. #	Color
380226	1529G	Gray
380224	1529B	Black
380227	1529W	White

Sold in case pack only.



Color
Gray
Black
White



Covers

- High impact polypropylene
- Color coded for easy identification
- Fits #1529 and #1537 tote boxes

Item #	Mfg. #	Description	Cs Pk	Cs Wt
399872	1531B	Black	12 x 1 ea	13.20 lb
399871	1531G	Gray	12 x 1 ea	13.20 lb
390201 ▼	1531W	White	1 x 12 ea	13.20 lb

Sold in case pack or eaches. ▼ Sold in case pack only.



Undercounter Box – Gray

- 21" x 12" x 6¼"d
- **Item #417262**
- Mfg. #1527G
- Cs Pk 1 x 1 dz
- Cs Wt 29.00 lb

Sold in case pack only.



Divided Tote Box – Gray

- 22" x 15" x 7"d
 - **Item #388045**
 - Mfg. #1547G
 - Cs Pk 1 x 6 ea
 - Cs Wt 20.25 lb
- Sold in case pack only.**



LUGS

- Ideal for transporting and storing all types of products – warm or cold food processing, preparation, etc
- High density, polyethylene
- Built-in handles
- Gray
- 16"w x 25"l x 8"h

Item #502495
Mfg. #WHPL-8GY
Cs Pk 1 x 6 ea
Cs Wt 6.00 lb

Sold in case pack only.



STAINLESS STEEL UTILITY CARTS



- Heavy duty welded construction
- 3 stainless steel shelves
- 3½" swivel casters, one ABS handle
- 12" distance between shelves
- 15½"w x 27½"l x 32½"h
- 300 lb capacity

Item #370902
Mfg. #97120
Cs Pk 1 x 1 ea
Cs Wt 29.42 lb



UTILITY CART

- Easy to clean, seamless plastic construction
- Two shelves offer 400 lb capacity (200 lb/shelf)
- 40⅞" x 25½" x 33" OA
- 5" casters
- Color: Beige

Item #368422
Mfg. #5805BE
Cs Pk 1 x 1 ea
Cs Wt 42.60 lb



KITCHEN



#UC-35G



3 TIER UTILITY CARTS

- Ships knocked down
- 33¼" x 17" x 37½"h
- Cs Pk 1 x 1 ea
- Cs Wt 22.05 lb

Item #	Mfg. #	Description
504999	UC-35G	Gray
505000	UC-35K	Black



#UC-35K



UTILITY CARTS

- Structural foam knock-down plastic carts with strong, thick cross-section plastic shelves
- 4" casters, two handles
- 10½" between shelves
- 18½"w x 30½"l x 39"h OA
- 200 lb capacity
- Color: Gray



Item #	Mfg. #	Description	Cs Pk	Cs Wt
379897	97111	Enclosed end panels	1 x 1 ea	53.55 lb
376035	97112	Open on four sides	1 x 1 ea	47.50 lb

SERVICE CART

- Ships knocked down
- 400 lb load capacity
- Three polypropylene shelves
- Marine rails around each shelf
- 11¾" space between shelves
- Aluminum uprights for sturdiness
- Two ergonomic handles
- Four 5" swivel steel casters – rust resistant, quiet and non-marking
- 40" x 21¼" x 37½"h
- Color: Speckled Gray



Item #446608
 Mfg. #BC340KD-480
 Cs Pk 1 x 1 ea
 Cs Wt 38.11 lb



KITCHEN

SERVICE CART & BINS

- Ships knocked down, easy to assemble
- 3 polypropylene shelves
- Marine rails around each shelf
- 11¾" space between shelves
- Aluminum uprights ensure sturdiness
- Two ergonomic handles
- Four 4" swivel, powder coated steel casters
- 32¾" x 16¼" x 38"
- Cs Pk 1 x 1 ea



#BC331KDSH-110 #BC331KDTC-110

Item #	Mfg. #	Description	Cs Wt
Service Carts			
423444	BC331KD-110	300 lb cap, Black	24.01 lb
421575	BC331KD-480	300 lb cap, Speckled Gray	24.01 lb
Accessories			
423448	BC331KDTC-110	Trash Container, 8 gal, Black	4.96 lb
423451	BC331KDSH-110	Silverware Bin, 2.5 gal, Black	2.25 lb



#BC331KD-110

#BC331KD-480

HEAVY-DUTY UTILITY BUS CART



- Plastic 3-tier design features brushed aluminum uprights
- 40" x 20" x 38"
- 300 lb capacity
- Non-marking 4" casters
- Shipped knocked down
- Color: Gray



Item #481458
 Mfg. #BC-3520G
 Cs Pk 1 x 1 ea
 Cs Wt 38.50 lb

BUSSING/UTILITY CART & BINS

- High-density plastic with aluminum uprights
- 3 reinforced shelves
- 400 lb capacity
- 4" swivel casters
- 36¾" x 16¼" x 31¼" OA
- Color: Black



#5810-BK shown with optional refuse bin (#5812BK) and silverware bin (#5811BK).

Item #369941
 Mfg. #5810BK
 Cs Pk 1 x 1 ea
 Cs Wt 24.33 lb



- Small Trash Container**
- 8.8 gallon capacity
 - Color: Black

Item #377377
 Mfg. #5812BK
 Cs Pk 1 x 2 ea
 Cs Wt 8.00 lb

Sold in case pack only.

- Small Silverware Bin**
- 2.45 gallon capacity
 - Color: Black

Item #377376
 Mfg. #5811BK
 Cs Pk 1 x 2 ea
 Cs Wt 4.00 lb

Sold in case pack only.

"BROILER MASTER" BRUSH

- Specially treated wooden head with two-sided stainless steel bristles, a metal end scraper and a 30" handle
- 8½" x 5" x 1½" head w/1" bristle trim
- Use with equipment turned off

Item #397362

Mfg. #4029000

Cs Pk 6 x 1 ea

Cs Wt 15.00 lb

Sold in case pack or eaches.



CLASSIC BROILER BRUSH

- Stainless steel bristles and scraper
- Double crimped collar
- 30" handle
- 8" head

Item #537843

Mfg. #90042

Cs Pk 6 x 1 ea

Cs Wt 12.00 lb

Sold in case pack or eaches.



HEAVY DUTY GRILL BRUSH

- Long stainless steel bristles
- 4' handle
- 7¾" double-sided head

Item #537845

Mfg. #90043

Cs Pk 4 x 1 ea

Cs Wt 17.00 lb

Sold in case pack or eaches.



CLASSIC PIZZA OVEN BRUSH

- Stainless steel scraper blade
- Brass bristles
- Double crimped collar
- 40" handle • 10" head

Item #537839

Mfg. #90041

Cs Pk 6 x 1 ea

Cs Wt 13.00 lb

Sold in case pack or eaches.

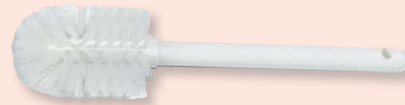

CARAFE BOTTLE BRUSH

- Plastic construction
- Small, soft polyester bristles provide delicate cleaning
- 12" long handle
- Color: White

Item #397466

Mfg. #4000002

Cs Pk 12 x 1 ea

Cs Wt 2.40 lb

Sold in case pack or eaches.



SPARTA® SPECTRUM® CUTTING BOARD BRUSHES

Assortment Pack

- Helps reduce the risk of cross contamination
- Color-coded to segregate brushes by task or work zone
- Assortment pack includes six brushes, color-coded for HACCP zone identification: Blue – seafood, Green – produce, Red – raw meat, Tan – cooked meat, White – dairy, and Yellow – poultry
- 6" long x 2½" wide w/polyester bristles

Item #380799

Mfg. #4134200

Cs Pk 1 x 1 set

Cs Wt 2.60 lb

Sold in case pack only.

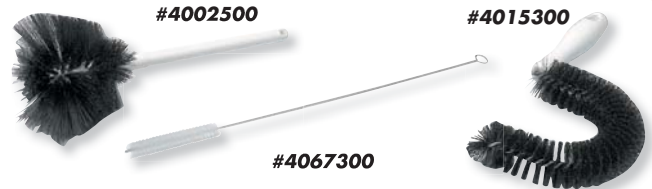

COFFEE BRUSHES

- Polyester bristles



Item #	Mfg. #	Description	Cs Pk	Cs Wt
Coffee Decanter Brush				
• Shaped like the inside of the most popular coffee decanters				
380844	4002500	16" long	6 x 1 ea	3.65 lb
Urn Gauge Brush				
• ¾" bristles for quick and easy cleanup of glass gauges				
380851	4067300	25" long	12 x 1 ea	0.95 lb
Coffee Maker Brush				
• Semi-circular wire wound brush, contours to inside of coffee pots				
380845	4015300	10" long	12 x 1 ea	3.00 lb

Sold in case pack or eaches.

HIGH TEMP FRYER BRUSH

- High temperature Teflon® bristles withstand temperatures up to 500°F
- 23" L-tipped w/7/8" bristles
- Teflon is a registered trademark of Dupont®
- Color: White

Item #380842

Mfg. #4011100

Cs Pk 12 x 1 ea

Cs Wt 5.35 lb

Sold in case pack or eaches.



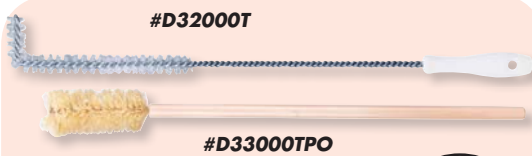

FRYER BRUSHES



• Cs Pk 12 x 1 ea

Item #	Mfg. #	Cs Wt
432213	D32000T	3.90 lb
432212	D33000TPO	5.50 lb

Sold in case pack or eaches.

SCOTCH-BRITE™ SCOUR PADS

Light Duty

- Soft, non-woven fibers gently clean the most delicate surfaces
- Color: White

Item #	Mfg. #	Description	Cs Pk	Cs Wt
373169	98	Mild Abrasive, 6" x 9"	3 x 20 ea	2.94 lb
386110	720	Dobie®, 4.375" x 2.69" x .56"	1 x 24 ea	1.60 lb
367784	9030	No-scratch, Thick, 3½" x 5"	1 x 40 ea	1.67 lb

Sold in case pack only.



Medium Duty

- General purpose, non-rusting, resilient, every day scour pads

Item #	Mfg. #	Description	Cs Pk	Cs Wt
367750	96	6" x 9", Green	3 x 20 ea	4.50 lb
434235	9488R	4" x 5¼", Blue	1 x 40 ea	1.49 lb
367758	9650	Thick, 3" x 4½", Green	2 x 40 ea	1.07 lb

Sold in case pack only.

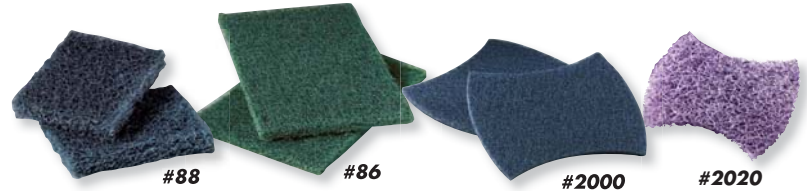

Heavy Duty

- Open construction for tough cleaning jobs

Item #	Mfg. #	Description	Cs Pk	Cs Wt
367752	88	Pot & Pan Handler, 3.5" x 5", Blue	4 x 10 ea	2.59 lb
367753	86	Scouring Pad, 6" x 9", Green	3 x 12 ea	2.65 lb
367764	2000	Power Pad, 5.5" x 3.9", Blue	1 x 20 ea	0.70 lb
396909	2000BP	Power Pad, 5.5" x 3.9", Blue	3 x 20 ea	2.43 lb
461320	2020	Scour Pad, 2.8" x 4.5", Purple	1 x 24 ct	1.09 lb
461970	2020CC	Scour Pad, 2.8" x 4.5", Purple	10 x 4 ct	1.50 lb

CASH AND CARRY
Sold in case pack only.



NYLON UTILITY BRUSHES

- Nylon bristle withstands the hottest temperatures
- Will not absorb odors or bacteria
- Cs Pk 12 x 1 ea
- Color: White

Item #	Mfg. #	Description	Cs Wt
380270	96501	8½" long	7.00 lb
380281	96511	20" long	11.00 lb

Sold in case pack or eaches.

MAXISCRUB™ BRUSH

- Angled head gets into corners • 1" trim
- Large handle protects knuckles
- Long lasting, highly durable polypro bristles
- Color: White

Item #515654
Mfg. #96312
Cs Pk 12 x 1 ea
Cs Wt 0.42 lb



Sold in case pack or eaches.



SCOTCH-BRITE™ SCRUB SPONGES

- Dual-action absorbing and cleaning with a wide range of scouring levels

Item #	Mfg. #	Description	Cs Pk	Cs Wt
367786	63	Light Duty, 3.69" x 6.13", White/Yellow	1 x 20 ea	2.28 lb
367769	74	Medium Duty, 3.5" x 6.25", Green/Yellow	1 x 20 ea	2.75 lb
367782	3000	Antibacterial Sponge, 2.8" x 4.5" x 0.6", Blue	1 x 20 ea	1.86 lb
369626	9489	Soft Scour!™ Scrub Sponge, 3.5" x 5", Blue	4 x 10 ea	4.28 lb

NIAGARA™ PRODUCTS (NOT SHOWN)

Item #	Mfg. #	Description	Cs Pk	Cs Wt
378910	74N	Scrubbing Sponge, Medium Duty, 3½" x 6"	1 x 20 ea	2.46 lb
378908	96N	Scouring Pad, Medium Duty, 6" x 9"	1 x 20 ea	1.08 lb
378909	86N	Scouring Pad, Heavy Duty, 6" x 9"	1 x 15 ea	1.00 lb
401798	88N	Extra Heavy Duty 3½" x 5", Blue	1 x 20 ea	1.08 lb
428099	9650N	Scrubbing Pad, Medium Duty, 3" x 4½", Green	2 x 40 ct	2.90 lb
402194	96NCC	Scouring Pad, Medium Duty, 6" x 9"	6 x 10 ct	3.70 lb

CASH AND CARRY
Sold in case pack only.

SCOTCH-BRITE™ EASY ERASING PAD

- Ideal for removing stains, marks, ink and more using only water
- 5½" x 2⅞" x 1¼"

Item #441709

Mfg. #4004CC
Cs Pk 3 x 4 ea
Cs Wt 0.63 lb

Sold in case pack only.



SCOTCH-BRITE™ SPONGE

- Antimicrobial, cellulose sponge resists odors, staining and crumbling
- 6" x 3⅜" x 1⅞"

Item #378915

Mfg. #A21
Cs Pk 24 x 2 ea
Cs Wt 4.18 lb

Sold in case pack only.



SCOURING PADS

- Treated with Ultra-Fresh™ antimicrobial agent



Item #	Mfg. #	Description	Cs Pk	Cs Wt
3½" x 5" – Green				
431943	MD9650/60	Medium Duty	1 x 60 ea	1.84 lb
6" x 9" – Green				
431919	HD69	Heavy Duty	6 x 10 ea	5.70 lb
431956	HD69/15	Heavy Duty, Pack of 15	1 x 15 ea	1.50 lb
432051	MD69	Medium Duty	6 x 10 ea	1.84 lb
431946	MD69/20	Medium Duty, Pack of 20	1 x 20 ea	1.32 lb

Sold in case pack only.

SPONGE & SCRUBBER

- Cellulose sponge absorbs water while the green abrasive pad helps cleaners work even better
- 3⅞" x 6¼"
- Medium duty

Item #431917

Mfg. #SS652
Cs Pk 8 x 5 ea
Cs Wt 3.35 lb

Sold in case pack only.



WALNUT® SCOURING PAD

- Contains organic crushed walnut shells
- Scratch resistant with aggressive cleaning action
- Safely cleans stainless steel, copper, coated cookware and any surface where scratching is a concern
- 6" x 9"

Item #431895

Mfg. #WP69/20
Cs Pk 1 x 20 ea
Cs Wt 1.14 lb

Sold in case pack only.

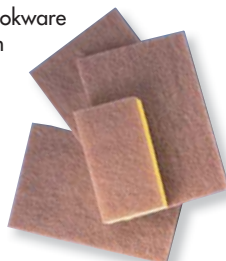

POT & PAN SCRUBBERS

- Heavy duty, blue
- 3½" x 5"
- Ultra-Fresh™ antimicrobial protection



Item #	Mfg. #	Cs Pk	Cs Wt
431957	PP80/20	1 x 20 ea	0.96 lb
431929	PP80	3 x 12 ea	2.00 lb
431928	PP88	4 x 10 ea	2.02 lb

Sold in case pack only.

#PP80



SOAP PADS

- Fine steel wool, soap impregnated pad, dissolves stubborn grease and lifts-off sticky food particles leaving behind a bright new shine
- 4" x 4", "hotel size"

Brillo®

Item #431958

Mfg. #SP1210BRILLO
Cs Pk 12 x 10 ea
Cs Wt 10.00 lb

Sold in case pack only.



Generic

Item #480369

Mfg. #SP1210
Cs Pk 12 x 10 ea
Cs Wt 10.00 lb

Sold in case pack only.



POT SCRUBBER

- Stainless steel

Item #501291

Mfg. #SSP-50
Cs Pk 1 x 1 dz
Cs Wt 1.38 lb

Sold in case pack only.



MAXISCOUR™ STAINLESS STEEL SCRUBBER

- High-grade stainless steel with four-sided strands
- Will not tear, splinter, rust or corrode

Item #425060

Mfg. #96142
Cs Pk 1 x 72 ea
Cs Wt 6.00 lb

Sold in case pack only.



400 SERIES STAINLESS STEEL SCRUBBERS



- Made from a single strand of stainless steel
- High quality – will not rust or splinter

Item #	Mfg. #	Description	Cs Pk	Cs Wt
432045	D204	Small, 1.25 oz	6 x 12 ea	6.55 lb
431941	D204/12	Small, 1.25 oz	1 x 12 ea	1.20 lb
432050	D104	Large, 1.75 oz	6 x 12 ea	8.96 lb
431942	D104/12	Large, 1.75 oz	1 x 12 ea	1.60 lb

Sold in case pack only.

3M



SCOTCH-BRITE™ STAINLESS STEEL SCRUBBERS & HOLDER

- High quality – will not rust or splinter

Item #	Mfg. #	Description	Cs Pk	Cs Wt
Scrubbers				
378913	83	Small, 1.25 oz	6 x 12 ea	7.99 lb
367789	84	Large, 1.75 oz	1 x 12 ea	1.60 lb
Scrubber with Floating Urethane Holder				
390020	87	4½" x 4½" x 2½"	1 x 18 ea	2.50 lb

Sold in case pack only.

REDCO® GRILL TENDER®



- Quickly and easily removes carbonized food from grill surface
- Splash guard and extra-long handle protects from burns



Item #	Mfg. #	Description	Cs Pk	Cs Wt
370922	1101	Scraper	1 x 1 ea	1.88 lb
378480	1102R	Replacement Blades	1 x 6 ea	0.68 lb

Sold in case pack only.

HOOD BAFFLE FILTER

- Welded S/S construction with drop handles
- 20" x 20" x 1½"d

Item #485831

Mfg. #HF-2020

Cs Pk 1 x 6 ea

Cs Wt 35.00 lb

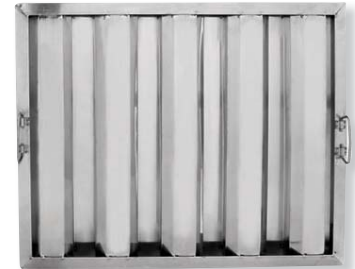

GRIDDLE SCREENS

- Light cleaning

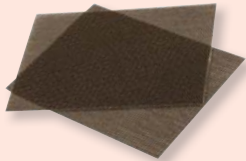

Item #	Mfg. #	Description	Cs Pk	Cs Wt
508281	G35	4" x 5½"	50 x 8 ea	8.00 lb
431940	GS10/20	4" x 5½"	10 x 20 ea	3.70 lb

Sold in case pack only.

GRIDDLE PADS & HOLDER

- Ideal for light cleaning or to polish grill surfaces



Item #	Mfg. #	Description	Cs Pk	Cs Wt
Pads 4" x 5½"				
431920	GP46	Pack of 6	6 x 10 ea	2.85 lb
431952	GP46/20	Pack of 20	1 x 20 ea	1.15 lb
Pad Holder, Heat Resistant up to 400°F				
488353	GPH10HR	Blue	10 x 1 ea	2.20 lb
432726	GPH10HR/2	Pack of 2	1 x 2 ct	0.38 lb

Sold in case pack only.

GRIDDLE CLEANING KIT

- Features the GPH10HR holder which is heat resistant up to 400°F. with gripping teeth to hold the griddle pad in place
- Handle, 40 screens and 10 pads



Item #431951

Mfg. #GCSHR

Cs Pk 1 x 1 kit

Cs Wt 1.45 lb



GRILBRIK®

- For use on hot grills without scratching or lifting
- Made for foodservice only
- 8" x 4" x 3½"

Item #436608

Mfg. #GB12DISCO

Cs Pk 1 x 12 ea

Cs Wt 7.00 lb

Sold in case pack only.



GRILL BRICK™ GRILL CLEANER

- Made of foamed glass stone, specially compounded to disintegrate during use to expose an unused surface
- 8" x 4" x 3½"

Item #378914

Mfg. #GB12

Cs Pk 1 x 12 ea

Cs Wt 7.00 lb

Sold in case pack only.



GRIDDLE STONE HOLDER

- Holder for Mfg. #3119 griddle stones

Item #397470

Mfg. #177

Cs Pk 12 x 1 ea

Cs Wt 16.66 lb

Sold in case pack or eaches.



EASY GRILL SCRAPER™

- Designed to help put more pressure on the blade, with less effort
- Heavy duty cast aluminum with stainless blade



"Exceeding your expectations"



Item #	Mfg. #	Description	Cs Pk	Cs Wt
423082	55825	Scraper	1 x 1 ea	3.00 lb
423275	55607-6	Replacement Blades	1 x 6 ea	1.00 lb

▼ Sold in case pack only.

SCOTCH-BRITE™ SCOTCHBRICK™ GRIDDLE SCRUBBER

- Heat resistant synthetic fiber scrubbing pad with built-in red handle
- For use at any operating temperature
- Heavy duty, 4" x 6" x 3"

Item #482277

Mfg. #9537CC

Cs Pk 3 x 4 ea

Cs Wt 3.30 lb

Sold in case pack only.



GRIDDLE CLEANING SYSTEMS

Scotch-Brite™ Griddle Cleaning System #200/46/461

- Designed for use on griddles that have been cooled down – replaces scrapers, grill stones and bricks
- Griddle pad holder protects hands from grease and burns
- Griddle polishing pad is used between holder and screen – adds final polish to grill
- Griddle screens are designed for heavy-duty cleaning of carbonized grease and food build-up

Item #	Mfg. #	Description	Cs Pk	Cs Wt
369645	461	3M™ Griddle Pad Holder, 2½" x 5¼" x 4", Blue Plastic Handle w/Metal Holder	1 x 10 ea	6.99 lb
367766	46	Scotch-Brite™ Griddle Polishing Pad, 4" x 5¼"	1 x 3 x 20 ea	2.83 lb
378911	46N	Niagara™ Griddle Polishing Pad, 4" x 5¼"	1 x 20 ea	0.68 lb
367776	200CC	Scotch-Brite™ Griddle Screen, 4" x 5½"	1 x 10 x 20 ea	3.60 lb
378912	200N	Niagara™ Griddle Screen, 4" x 5½"	1 x 10 x 20 ea	3.60 lb

Sold in case pack only.

Scotch-Brite™ Griddle Pad

- Removes heavily burned-on food and grease to provide a spotless, shiny griddle in minutes – even hot griddles
- Griddle pad has open web construction for the toughest jobs
- Heavy duty, 4½" x 5½"

Item #367759

Mfg. #82
Cs Pk 1 x 4 x 10 ea
Cs Wt 2.85 lb

Sold in case pack only.



Shown with holder sold separately

SCOTCH-BRITE™ SQUEEGEE

- Flexible, heat-resistant 7" rubber blade attached to a long handle to safely remove liquid residue from the griddle surface to the grease trap



Item #	Mfg. #	Description	Cs Pk	Cs Wt
378964	410	Squeegee	1 x 1 ea	0.96 lb
464559	411	Replacement Blade	12 x 1 ea	0.21 lb

Sold in case pack or eaches.



SCOTCH-BRITE™ QUICK CLEAN SMALL APPLIANCE CLEANER

- Loosens and lifts carbonized grease and food soil from the grids when applied to a hot waffle maker surface
- One quart bottle

Item #391135

Mfg. #702
Cs Pk 2 x 1 qt
Cs Wt 6.00 lb

Sold in case pack only.



Not Available via FedEx®.



SCOTCH-BRITE™ MULTI-PURPOSE PAD HOLDER

- Designed to hold a variety of Scotch-Brite™ hand pads, including the #46
- 17" long handle

Item #393216

Mfg. #405R
Cs Pk 1 x 1 ea
Cs Wt 0.64 lb



SCOTCH-BRITE™ QUICK CLEAN GRIDDLE SYSTEM

- Contains the tools necessary to safely and effectively clean your griddle – designed to be used on hot griddles (300-350°F)
- Starter kit includes 10 Scotch-Brite™ Quick Clean Griddle Liquid Packets (#700), Scotch-Brite™ Squeegee (#410), Scotch-Brite™ Multi-Purpose Pad Holder (#405R) and the Scotch-Brite™ Griddle Polishing Pad (#46)

Item #	Mfg. #	Description	Cs Pk	Cs Wt
378916	710	Quick Clean Kit	1 x 1 ea	5.00 lb
397035	700-40	Griddle Liquid, 3.2 oz Packet	1 x 40 ea	11.90 lb
378962	701	Griddle Liquid, 1 quart Bottle	4 x 1 qt	12.00 lb

Sold in case pack only.



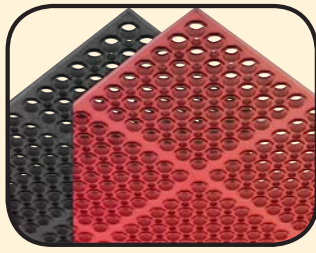

KITCHEN & BAR MATS

- Fight fatigue at check-outs, prep stations and other areas where employees stand
- Reduces the effects of floor hardness by as much as 50%
- Made of closed-cell vinyl for durable comfort
- Mop-clean for easy care • Cs Pk 1 x 1 ea

Item #	Mfg. #	Description	Cs Wt
397797	KM1100	Bar Mat, 3' x 5' x 1/2", Black	25.00 lb
397801	KM2100	Bar Mat, 3' x 5' x 3/4", Black	30.00 lb
397800	KM1200	Kitchen Mat, 3' x 5' x 1/2", Red	25.00 lb

SAN JAMAR
Smart • Safe • Sanitary

CATALINA OLEFIN CARPET MAT

- Protects floors from damaging dirt, moisture and wear
- Long-wearing 100% continuous filament olefin pile
- Solution dyed fibers will not fade or discolor in sunlight
- Traps 1.2 gal of water per square yard
- Size: 3' x 5', approximately 3/16" thick
- Color: Pebble Brown



CACTUS MAT MFG. CO.

Item #476178
Mfg. #1437M-B35
Cs Pk 1 x 1 ea
Cs Wt 12.00 lb



VIP-DELUXE MATS

- Anti-fatigue - eases strain of standing, improves worker productivity
- Anti-slip - aggressive surface design provides security underfoot
- Raised surface edges provide safe footing
- Large holes permit waste and liquid to pass below surface
- Raised underside knobs promote improved drainage
- Extra thick edges prevent tearing during handling
- 3/8" thick • 5 year guarantee • Cs Pk 1 x 1 ea



Item #	Mfg. #	Description	Cs Wt
476175	2520-C3	29" x 39", General Purpose, Black	19.00 lb
476174	2520-C1	58 1/2" x 39", General Purpose, Black	38.00 lb
476177	2520-R3S	29" x 39", Grease Resistant, Red	19.00 lb
476176	2520-R1S	58 1/2" x 39", Grease Resistant, Red	38.00 lb

VIP MATS

- Anti-slip, anti-fatigue kitchen and bar matting
- Made of 3/8" thick rubber to be lighter in weight and easier to handle
- Excellent drainage
- Cs Pk 1 x 1 ea

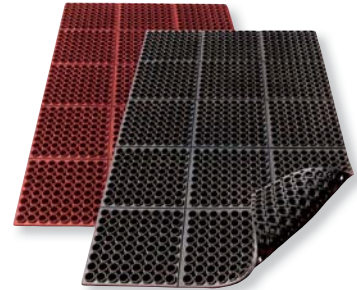

Item #	Mfg. #	Description	Cs Wt
VIP-Tuff-Dek - 3' x 5', no guarantee			
476171	3525-C1	General Purpose, Black	34.00 lb
476173	3525-R1	Grease Resistant, Red	34.00 lb
VIP-Floormate - 58 1/2" x 39", HD Economy, no guarantee			
507513	3520-R1	Grease & Oil Resistant, Red	40.00 lb

VIP-TOPDEK JR. MATS

- The lighter weight mat that combines economy and utility
- Made of 1/2" thick rubber with a beveled edge
- This anti-fatigue, anti-slip mat is easy to handle and durable
- Size: 3' x 5'
- Cs Pk 1 x 1 ea



CACTUS MAT MFG. CO.

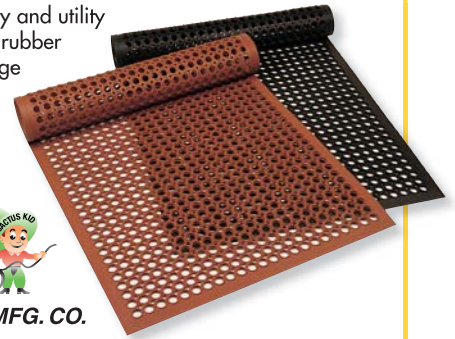

Item #	Mfg. #	Description	Cs Wt
476169	2530-C5	General Purpose, Black	20.00 lb
476170	2530-R5	Grease Resistant, Red	20.00 lb

VIP-RED/BLACK CLOUD MATS

- Lightweight and grease proof (red and black)
- Non-absorbent closed-cell foam rubber, 3/4" thick
- Antimicrobial additive to prevent mold, mildew and bacterial growth
- Tapered on all sides for safety with drainage holes for wet areas
- Anti-slip textured surface
- 5 year guarantee against breakdown from grease
- Size: 3' x 5' • Cs Pk 1 x 1 ea

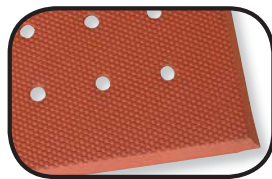

Item #	Mfg. #	Description	Cs Wt
476180	5000-R35	Red	12.50 lb
480101	2200-35	Black	12.50 lb

HONEYCOMB ANTI-FATIGUE MAT

- Honeycomb design adds strength and durability
- Open hole design promotes good drainage
- Anti-slip surface promotes safety
- Anti-fatigue for improved comfort
- Size: 3' x 4' x 3/16" thick, general purpose
- Color: Brown



CACTUS MAT MFG. CO.

Item #476179
Mfg. #2535-B34
Cs Pk 1 x 1 ea
Cs Wt 20.00 lb

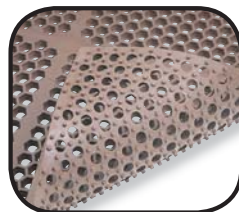

MAT WASH RACK & TRANSPORTER

- Speeds up the handling, cleaning and drying of kitchen, bar and industrial mats
- Quick and easy transportation
- Holds up to 10 VIP-DELUXE mats, or even more thinner mats (mats must have continuous hole pattern)
- Zinc plated, 16 ga. cold rolled 1" tubular steel
- Four 5" rubber swivel casters
- 500 lb capacity
- Shipped knocked down
- 42"l x 28"w x 40"h



CACTUS MAT MFG. CO.

Item #476181
Mfg. #6477-KD
Cs Pk 1 x 1 ea
Cs Wt 62.00 lb





White

Grey

Blue

ROUND HUSKEE™ CONTAINERS & LIDS

- Molded of engineered resins with seamless construction – stackable with lid on, nestable with lid off
- Lid features snap-tight fit – keeps lid and contents securely in place, even if overturned
- Containers and lids sold separately



Item #	Mfg. #	Description	Cs Pk	Cs Wt
Containers				
483668	1001GY	10 gallon, Grey	6 x 1 ea	19.14 lb
483672	1001WH	10 gallon, White	6 x 1 ea	19.14 lb
483673	2000GY	20 gallon, Grey	6 x 1 ea	38.76 lb
483674	2000WH	20 gallon, White	6 x 1 ea	38.76 lb
483675	3200GY	32 gallon, Grey	6 x 1 ea	57.60 lb
484998	3200-1	32 gallon, Blue	6 x 1 ea	57.60 lb
483676	3200WH	32 gallon, White	6 x 1 ea	57.60 lb
483677	4444GY	44 gallon, Grey	4 x 1 ea	50.48 lb
483678	4444WH	44 gallon, White	4 x 1 ea	50.48 lb
483679	5500GY	55 gallon, Grey	3 x 1 ea	52.44 lb
Lids				
483680	1002GY	Fits 10 gallon, Grey	6 x 1 ea	5.40 lb
483681	1002WH	Fits 10 gallon, White	6 x 1 ea	5.40 lb
483682	2001GY	Fits 20 gallon, Grey	6 x 1 ea	10.20 lb
483683	2001WH	Fits 20 gallon, White	6 x 1 ea	10.20 lb
483684	3201GY	Fits 32 gallon, Grey	6 x 1 ea	13.80 lb
483685	3201WH	Fits 32 gallon, White	6 x 1 ea	13.80 lb
483686	4445GY	Fits 44 gallon, Grey	4 x 1 ea	11.24 lb
483687	4445WH	Fits 44 gallon, White	4 x 1 ea	11.24 lb
484335	5501GY	Fits 55 gallon, Grey	3 x 1 ea	12.75 lb

Sold in case pack or eaches.

SMOKING RECEPTACLE

- Polyethylene construction can withstand outdoor elements without rust or corrosion
- Large, 4 gallon steel pail is easily accessed for emptying and cleaning
- Holds over 3,000 extinguished cigarette butts
- 41" h x 14" w • Color: Beige

Item #457696
Mfg. #887BE
Cs Pk 1 x 1 ea
Cs Wt 9.00 lb



FLOOR SAND URN

- One-piece structural plastic with chrome ashtray top
- Color: Black
- 20" h x 10" diameter

Item #372851
Mfg. #888BK
Cs Pk 1 x 1 ea
Cs Wt 7.31 lb



HUSKEE™ DOME TOP

- Wide rim and tight fitting door with rain deflector keeps debris and odors in and rain and pests out
- Fits 32, 44 and 55 gallon Huskee™ containers, grey

Item #484333
Mfg. #5550GY
Cs Pk 2 x 1 ea
Cs Wt 19.36 lb



Sold in case pack or eaches.

STRUCTO DOLLY

- Rugged black structural plastic
- Twist-on, twist-off without tools
- Fits on 20, 32, 44 and 55 gallon Huskee™ containers
- 5 non-marking full swivel 3" ball bearing casters

Item #483688
Mfg. #3255
Cs Pk 2 x 1 ea
Cs Wt 12.00 lb



Sold in case pack or eaches.



ROUN' TOP

- 24 gallon capacity, brown
- Factory Mutual Fire Resistant design contains and extinguishes fire

Item #373929
Mfg. #1425BN
Cs Pk 1 x 1 ea
Cs Wt 23.50 lb



DELUXE STEEL HAND TRUCK

- Handles cartons or drums up to 55 gallons
- Blue enamel finish is rust and corrosion resistant
- Large 10" x 2 3/4" solid wheels

Item #379928
Mfg. #43
Cs Pk 1 x 1 ea
Cs Wt 36.13 lb

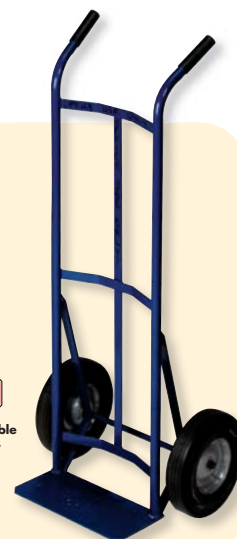

STEP STOOL

- Structural plastic, holds 300 lb
- Four retractable, non-marking casters, anti-skid bottom
- Color: Black

Item #369931
Mfg. #523BK
Cs Pk 1 x 1 ea
Cs Wt 8.30 lb





#25BE

#1702BE

#4114BK

#2818BN

#1358BE

Colors pictured may not represent available colors.



JUMBO SQUARE WASTEBASKET AND LID

- Durable rolled rim and reinforced base for rough commercial use
- Nest easy for storage
- Color: Beige
- Cs Pk 4 x 1 ea



Item #	Mfg. #	Description	Cs Wt
483695	25BE	25 Gallon Container	33.32 lb
483696	1702BE	Drop Shot Lid, fits 25	17.76 lb

Sold in case pack or eaches.

RECTANGULAR WASTEBASKETS

- Seamless construction makes for easy cleaning
- Cs Pk 12 x 1 ea

Item #	Mfg. #	Description	Cs Wt
483697	4114BE	4 1/4 quart, Beige	35.16 lb
483698	4114BK	4 1/4 quart, Black	35.16 lb
483699	2818BE	28 1/8 quart, Beige	27.00 lb
483700	2818BK	28 1/8 quart, Black	27.00 lb
483701	1358BE	13 3/8 quart, Beige	15.00 lb
483702	1358BK	13 3/8 quart, Black	15.00 lb

Sold in case pack or eaches.

JANITORIAL



#8321BE

#8322GY

#8322BN

#8321GY

WALL HUGGER™ RECEPTACLES

- Made of polyethylene with rolled top edge
- Smooth seamless design is easy-to-clean
- Protrudes less than 12" from the wall
- Made in USA



Item #	Mfg. #	Description	Cs Pk	Cs Wt
Rectangular - 23 gallon capacity				
503818	8322BN	Receptacle, Brown	1 x 1 ea	33.00 lb
498959	8322GY	Receptacle, Grey	1 x 1 ea	33.00 lb
Half Round - 21 gallon capacity				
483693	8321BE	Receptacle, Beige	2 x 1 ea	15.20 lb
483694	8321GY	Receptacle, Grey	2 x 1 ea	15.20 lb

Sold in case pack or eaches.

WALL HUGGER™ DROP SHOT LID

- Fits 23 gallon receptacle
- Helps to conceal waste while providing an inviting, enlarged opening for waste disposal



Item #503766
Mfg. #7325GY
Cs Pk 1 x 1 ea
Cs Wt 2.71 lb



PREMIUM NOZZLE & HOSE



Nozzle

- For hot water use
- 5/8" diameter

Item #379624
Mfg. #725369
Cs Pk 10 x 1 ea
Cs Wt 5.00 lb

Hose

- Temperature range: up to 200°F
- 50' long x 5/8" diameter

Item #379626
Mfg. #724311
Cs Pk 5 x 1 ea
Cs Wt 50.00 lb

Sold in case pack and eaches.

PUSH POWER SWEEPER

- 29" wide • 12.4 gallon debris container
- Sweeps wet & dry leaves
- Light weight with side rollers that make sweeping along walls an ease
- No electricity needed • Belt free system
- Stand up storage design for easy storage
- Comes with lubricant spray
- Lifetime warranty on brushes
- One year overall warranty

Item #531718*
Mfg. #PPS29
Cs Pk 1 x 1 ea
Cs Wt 23.10 lb
** Special Order*



UPRIGHT VACUUM

- 12" wide cleaning head covers a wider area and leaves no center dirt path
- Exclusive MicroSweep™ goes from carpet to bare floors with no adjustments
- Weighs only 8 pounds
- Cord guard prevents cord damage
- Clear, non-marring bumpers
- Fingertip-controlled on/off switch
- Ingenious top-fill design keeps power at maximum even while bag fills
- Powerful, high-speed, balanced, double helix brushes whirl at 6500 RPM
- RPM circuit breaker, shuts off motor when brush roller RPMs slow down
- **5 year warranty on belt**

Item #538780
Mfg. #U2000EB
Cs Pk 1 x 1 ea
Cs Wt 13.00 lb



TOOLS-ON-BOARD UPRIGHT VACUUM

- 14" cleaning path
- High efficiency filtration includes motor inlet filter and dual wall disposable bags
- Powerful 1000 watt dual motor
- Full set of attachments includes upholstery brush, dusting brush and crevice tool
- Telescopic wand and stretch hose extend more than 9 feet
- Two year commercial warranty

Upright Vacuum
Item #463317
Mfg. #UPRO14T
Cs Pk 1 x 1 ea
Cs Wt 26.81 lb



Replacement Bags
Item #464485
Mfg. #PK10PRO14DW
Cs Pk 1 x 10 ea
Cs Wt 3.00 lb



PREMIER UPRIGHT VACUUM

- Powerful 870W motor
- Heat overload protection system
- Large rear wheels make transportation easy
- Teflex outer bag
- Chrome motor hood
- Helping Hand®
- 16" cleaning path
- Aluminum roller brush
- Lifetime warranty on fan
- Magnet bar
- 50' power cord

Item #520385*
Mfg. #OR102
Cs Pk 1 x 1 ea
Cs Wt 21.85 lb
** Special Order*



XL PRO™ BACKPACK VACUUM

- Durable and lightweight
- Provides exceptional cleaning ability on a wide range of surfaces
- Shoulder strap support plus the added stability of an ergonomic waist belt that helps balance the unit on operator's hips
- 6 quart
- 5 year motor warranty

Item #538782*
Mfg. #XLPRO6A
Cs Pk 1 x 1 ea
Cs Wt 21.95 lb
** Special Order*



JANITORIAL

XL® PRO 5 VACUUM

- Weighs only 5 pounds but has the power of heavier canisters
- Quiet, high-vortex motor
- Comes with 11 handy attachments
- Disposable dust bag and air filter
- Shurlock® positive locking system ensures accessories stay in place

Item #423465
Mfg. #BB900DGR
Cs Pk 1 x 1 ea
Cs Wt 8.00 lb



VACUUM CLEANER BAGS & BELTS

Item #	Mfg. #	Description	Cs Pk	Cs Wt
423470	PK8000.25	25 Bags for U2000E, U2000EB	1 x 25 ea	3.10 lb
423474	PKBP10.10QT	10 Bags for XLPRO6A	1 x 10 ea	0.95 lb
423475	030.0604	3 Pack Vac Belts for Uprights	1 x 3 ea	0.25 lb

Sold in case pack only.

SWEEP-N-GO CORD-FREE ELECTRIC SWEEPER

- Rechargeable system with revolving agitator brush and geared belt drive for superior quick pickup cleaning on all surfaces
- Long life Nickel Magnesium battery with 90 minute run time
- Extra long life energy saving geared motor
- Titanium bushings for brush roller
- Laser balanced brush roller and wheels
- Non slip geared belt
- Virtually indestructible hi impact housing and hood
- See thru front housing to view any possible blockage
- Dust bin designed to seal dust from leaking into motor housing
- Weighs only 3.9 lb
- One year limited warranty

Item #538497
Mfg. #PR9100NM
Cs Pk 1 x 1 ea
Cs Wt 5.50 lb

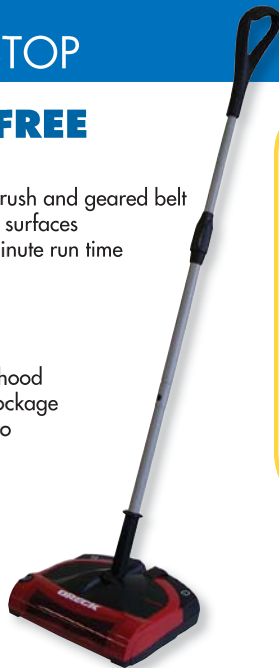

#PR2600



#PR3200

HOKY® SWEEPERS

- Wet/Dry sweepers with exclusive, patented Rotorblade® wipers
- Center pivot handle sections friction fit together but can be separated for easy storage
- Litter baffles trap debris in the dustpan
- Soft rubber wheels provide a sure grip and prevent marking
- High impact ABS body wipes clean with a damp cloth
- PR3200 with its larger head covers areas faster, picks up everything, even broken glass
- Color: Midnight Blue • Cs Pk 1 x 1 ea

Item #	Mfg. #	Cleaning Head Dimensions	Cs Wt
423468	PR2600	9½" w x 8" l x 3" h	2.80 lb
423469	PR3200	12½" w x 11" l x 3½" h	5.00 lb

HUSKEE™ POWERROTOR™ SWEEPERS

- Patented rubber singular agitators clean both hard floors and carpets
- Self-cleaning flexible blades beat the floor with high frequency, creating friction and momentum that cleanly transports dirt, food, lint and other debris into the dust compartments
- Sturdy ABS construction with rubber corner blades, non-marking wheels
- Noiseless operation, outlasts conventional sweepers 8 to 1
- Color: Graphite Black



Item #	Mfg. #	Description	Cs Pk	Cs Wt
394834	5325	9½" wide	10 x 1 ea	25.10 lb
399881	5327	12½" wide	5 x 1 ea	18.70 lb

Sold in case pack or eaches.

FLOOR SWEEPERS

- Whisk away dirt and debris from virtually any floor surface
- Two rubber eight-bladed rotorblades, collect both large and small debris
- No more bristles to wear out or clog with hair, thread or string
- Center pivot handle makes it possible to push in either direction
- Cs Pk 1 x 1 ea



Item #	Mfg. #	Cleaning Head Dimensions	Cs Wt
369637	4500	10" w x 8½" l x 3" h	3.58 lb
378920	6000	12½" w x 12" l x 4" h	5.70 lb

AIR MOVER/FLOOR DRYER

- Easily adjusts to 4 different positions; lets you dry hard floors, carpets, furniture, curtains & ceilings
- Heavy-duty polyethylene housing
- 9½" diameter blower fan
- ½ hp motor with 3 speed switch
- 25 foot long safety cord
- 1 year warranty on motor and housing



Item #432386
Mfg. #AM10.D
Cs Pk 1 x 1 ea
Cs Wt 33.00 lb



ORBITER FLOOR MACHINE

- Sands, refinishes, strips, scrubs, waxes, polishes, and cleans all floor surfaces
- Oscillating motion reaches every corner right out to the baseboard
- Includes a 35' cord
- Weighs 24 lb
- Cleans a 13" path
- 1 year commercial warranty on total unit, with a 5 year motor warranty

Item #531721*
Mfg. #550MC
Cs Pk 1 x 1 ea
Cs Wt 32.90 lb



* **Special Order**
Hard Surface Kit includes 12" Scrub Brush, Union Mix Brush, Polish Pad, Scrub Pad, Strip Pad and 2 lb Container of Timber Works.
Dry Carpet Cleaning Kit includes 12" Dry Shampoo Brush, Carpet Bonnet, 32 oz Soil Release Premist, 4 lb Pail Dry Shampoo.

Item	Mfg. #	Description	Cs Wt
#538783*	A Package	Hard Surface Kit	7.00 lb
#538784*	B Package	Dry Carpet Cleaning Kit	7.00 lb

* **Special Order**

SUPER DOOR STOP

- Save Money – Hold the door without bending over and reduce injury costs due to back strain or improperly secured doors
- Save Time – A built in magnet allows you to secure it to any metal surface and keep it close at hand
- Don't Slip – Patented design and unique material combine to secure doors on almost any surface, including carpet
- Color: Yellow

Item #531831
Mfg. #280173
Cs Pk 6 x 1 ea
Cs Wt 2.00 lb



J.W. ATOMIC LOOP™ MOP

- The perfect choice when upgrading from cut-end mops
- Cotton/ rayon/ synthetic blend
- Launderable • Medium, green
- 5" headband
- Uses any handle below

Item #431775
Mfg. #A02802.D02
Cs Pk 1 x 2 ea
Cs Wt 3.00 lb
Sold in case pack only.



J. W. Atomic Loop™

ROUGH RIDER™ WET MOPS

- Very absorbent cotton strands deliver high performance for maximum efficiency
- Medium white • 1.25" headband
- Uses any handle below

Item #431796
Mfg. #A03312.D02
Cs Pk 1 x 2 ea
Cs Wt 3.00 lb
Sold in case pack only.



RoughRider™

TEXRAY™ 4-PLY RAYON MOPS

- Great for liquid clean-up, disinfecting or applying finish
- 24 oz white • 1.25" headband
- Uses any handle below

Item #431790
Mfg. #A414124.D03
Cs Pk 1 x 3 ea
Cs Wt 5.50 lb
Sold in case pack only.

Item #380075
Mfg. #A414124
Cs Pk 1 x 12 ea
Cs Wt 19.00 lb
Sold in case pack only.



Texray



Go-Go™ Blend

GOGO™ CUT-END MOP

- Premium cotton/ rayon blend
- #24 blue • 1.25" headband
- Uses any handle below

Item #399650
Mfg. #A427124
Cs Pk 1 x 12 ea
Cs Wt 15.96 lb
Sold in case pack only.



Bulldog™



BULLDOG™ MOPS

- Looped end, economical mop for general purpose cleaning
- Uses any handle below

Item #	Mfg. #	Description	Cs Pk	Cs Wt
1.25" Headband				
380002	A05011	Small, Natural	1 x 12 ea	10.20 lb
380004	A05012	Medium, Natural	1 x 12 ea	13.80 lb
380006	A05013	Large, Natural	1 x 12 ea	19.44 lb
5" Headband				
431451	A04902.D02	Medium, Natural	1 x 2 ea	2.50 lb
431768	A05103.D02	Large, Blue	1 x 2 ea	4.00 lb

Sold in case pack only.

STINGER™ COTTON CUT-END WET MOPS

- Natural cotton fibers for general purpose mopping
- 1.25" headband, natural
- Uses any handle below

Item #	Mfg. #	Description	Cs Pk	Cs Wt
443837	A901112	#16	1 x 12 ea	13.42 lb
379998	A902116	#20	1 x 12 ea	11.76 lb
379999	A903120	#24	1 x 12 ea	16.92 lb
380000	A904128	#32	1 x 12 ea	23.04 lb
431779	A903120.D03	#24	1 x 3 ea	4.50 lb
431781	A904128.D03	#32	1 x 3 ea	6.00 lb
431776	A0401124.D03	24 oz	1 x 3 ea	5.50 lb
431777	A0401132.D03	32 oz	1 x 3 ea	7.00 lb

Sold in case pack only.



LEADER YACHT COTTON MOP

- 4-ply, cord tied cotton yarn is securely attached to a wood handle
- 24 oz white • 1.25" headband

Item #431797
Mfg. #A605024
Cs Pk 1 x 6 ea
Cs Wt 15.00 lb
Sold in case pack only.



JANITORIAL

MOP STICKS



Not Available via FedEx®.



- Break-A-Way Style**
- 7½" w head, for mops with narrow headbands
 - Cs Pk 12 x 1 ea

Item #	Mfg. #	Description	Cs Wt
538288	608	Fiberglass, 60" x ⅛"	18.36 lb

Sold in case pack or eaches.



- Night Stick-Stirrup Style**
- 7½" w head, for mops with narrow headbands
 - Cs Pk 12 x 1 ea

Item #	Mfg. #	Description	Cs Wt
538289	596	Fiberglass, 64" x ⅛"	18.12 lb

Sold in case pack or eaches.

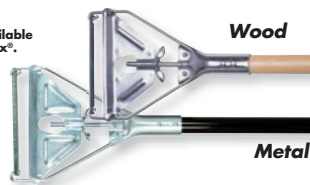

- Quick Change Style**
- 6½" w head, for mops with narrow headbands
 - Cs Pk 12 x 1 ea

Item #	Mfg. #	Description	Cs Wt
521218	A70902	Wood, 62" x 1½"	32.40 lb
538290	772	Steel, 63" x 1"	32.40 lb

Sold in case pack or eaches.



- Jaws Mop Stick**
- For mops with wide headbands
 - Cs Pk 12 x 1 ea

Item #	Mfg. #	Description	Cs Wt
538293	601	Fiberglass, 60" x 1½"	16.81 lb

Sold in case pack or eaches.

MOP STICKS: All may be used with above mop heads, with the exception of #431797

NO MARR PINNACLE™ MOPS



- Natural 4-ply cotton or rayon yarn with a Pinnacle screw on handle attachment



Item #	Mfg. #	Description	Cs Pk	Cs Wt
431783	A903320.D03	#24, Cotton	1 x 3 ea	4.50 lb
431795	A913320.D03	#24, Rayon	1 x 3 ea	4.50 lb
488476	A904324	#32, Cotton	1 x 12 ea	18.00 lb

Sold in case pack only.

PINNACLE™ WOOD MOP HANDLE

- Metal threaded connector is countersunk into wood handle for fast and efficient mop head changes
- For use with Pinnacle™ mops • 1 1/8" x 60"

Item #431449

Mfg. #A71302

Cs Pk 1 x 12 ea

Cs Wt 15.00 lb

Sold in case pack only.



Not Available via FedEx®.



#97232-NB3

#97113-3

#97413-3

COTTON LOOP-END MOPHEADS

- 4 ply cotton • Loop-end prevents raveling or tangled ends
- Fantail spreads mophead out for faster mopping
- Uses flat handle or mop stick
- 5" headband
- Cs Pk 1 x 3 ea



Item #	Mfg. #	Description	Cs Wt
399842	97232-NB-3	Antimicrobial, Orange, Medium	3.50 lb
399844	97113-3	Blend, White, Large	3.50 lb
472098	97412-3	Cotton, Medium	3.50 lb
399846	97413-3	Cotton, Large	3.50 lb

Sold in case pack only.

QUICK CHANGE® MOP STICKS

- Easy trigger release allows you to quickly discard soiled mop heads without touching
- For all mop heads with narrow or wide band



60", Fiberglass	60", Metal
Item #399835	Item #399834
Mfg. #96516	Mfg. #6516
Cs Pk 1 x 6 ea	Cs Pk 1 x 12 ea
Cs Wt 9.00 lb	Cs Wt 10.00 lb

Sold in case pack only.



#97724V-3

#97924-3

#97831-3

COTTON & RAYON MOPHEADS

- Cut-end mopheads • Good for general purpose mopping
- 4-ply yarn • 1 1/4" headband • Uses flat handle or mop stick
- Cs Pk 1 x 3 ea

Item #	Mfg. #	Description	Cs Wt
Cotton & Rayon Mop Heads			
399822	97716V-3	16 oz Cotton, Economy	3.75 lb
399841	97720V-3	20 oz Cotton, Economy	4.25 lb
399823	97724V-3	24 oz Cotton, Economy	4.50 lb
429491	97613V-3	24 oz Cotton	5.00 lb
399824	97732V-3	32 oz Cotton, Economy	6.50 lb
399825	97924-3	24 oz Rayon	5.00 lb

Flat Cotton & Rayon Mop Heads

412434	97822-3	#24 Cotton	4.50 lb
399831	97831-3	#24 Rayon	5.00 lb

Sold in case pack only.

MAXI-CLEAN™ LOOP END MOPHEADS

- MaxiClean™ high quality yarn provides excellent absorbency and durability
- Loop-end prevents fraying or tangling ends
- Fantail spreads mophead for faster mopping
- Uses flat handle or mop stick
- Large, 5" headband
- Cs Pk 1 x 3 ea
- Cs Wt 5.00 lb



#97147-3

Item #	Mfg. #	Description
399826	97147-3	Green Yarn
399827	97157-3	Blue Yarn

Sold in case pack only.



#97157-3

FLAT MOP HANDLE

- Firm-Grip™ metal handle won't crack, warp or splinter
- For use with all flat mopheads
- 1 1/8" x 60"

Item #480841
Mfg. #97518
Cs Pk 1 x 1 ea
Cs Wt 1.16 lb



Not Available via FedEx®.



LIGHT & THIRSTY® CLOTH MOP REFILL

- Greater capacity for spills; will not shred or lint
- Lightweight for ease of mopping
- Easy refill replacement; machine wash and dry

Item #423839
Mfg. #000226
Cs Pk 12 x 1 ea
Cs Wt 4.69 lb
Sold in case pack or eases.



Not Available via FedEx®.

Handle sold separately.



MAXISCRUB™ SPONGE MOP

- 9" metal frame
- FirmGrip™ steel handle
- Cellulose sponge leaves floor drier
- Scrubber strip removes stubborn dirt

Item #	Mfg. #	Description	Cs Pk	Cs Wt
514347	94201	Power Strip® Mop	6 x 1 ea	13.00 lb
380254	94205	Refill Mop Head	1 x 12 ea	2.55 lb

Sold in case pack or eases. Sold in case pack only.



Not Available via FedEx®.

BUCKET/WRINGER COMBO PACK

- 26 quart bucket with 3" casters & squeeze wringer for 12 to 32 oz mops
- Color: Yellow

Bucket/Wringer Combo

Item #487489
Mfg. #226-312YW
Cs Pk 1 x 1 ea
Cs Wt 17.46 lb

Bucket Only

Item #385596
Mfg. #226-3YW
Cs Pk 1 x 1 ea
Cs Wt 23.31 lb

#226-312YW



UNIBODY® MOPPING SYSTEM

- The one-piece design is the most efficient side-press wringing system available
- Standard w/drain grate, spigot, non-marking 3" ball bearing casters and 35 quart bucket and side-press wringer
- Color: Yellow

Item #384445
Mfg. #351YW
Cs Pk 1 x 1 ea
Cs Wt 11.50 lb



STRUCTOLENE® MOP BUCKET

- 44 quart super durable Structolene® mop bucket with pleated steel bail
- 3" non-marking grey casters
- Embossed graduations and universal "caution" logo
- Fits Continental® SW7 and SW12 wringers
- Derma-Tek® finish
- Color: Yellow

Item #437900
Mfg. #404-3YW
Cs Pk 1 x 1 ea
Cs Wt 15.00 lb



MOP WRINGERS

- Color: Yellow
- Cs Pk 1 x 1 ea

Side-Press
12 to 32 oz Mops
Item #488902
Mfg. SW12YW
Cs Wt 7.00 lb

Down-Press (Geared)
16 to 32 oz Mops
Item #410690
Mfg. SW7YW
Cs Wt 11.00 lb



#335-37YW

SPLASHGUARD™ COMBO PACK

- 35 quart bucket with 3" casters & downpress (geared) wringer for 16 to 24 oz mops
- Color: Yellow
- Cs Pk 1 x 1 ea

Bucket/Wringer Combo

Item #413555
Mfg. #335-37YW
Cs Wt 28.00 lb

Bucket Only

Item #390552
Mfg. #335-3YW
Cs Wt 13.54 lb



MAXICLEAN™ MOP BUCKET & WRINGER

- 36 quart yellow bucket
- Separates clean and dirty water
- Efficient side-press wringer performs like a downpress wringer

Item #429480
Mfg. #96978
Cs Pk 1 x 1 ea
Cs Wt 22.40 lb



MAXIROUGH™ MOP BUCKET & WRINGER

- 32 quart yellow bucket
- Sidepress wringer for use up to 32 oz mops
- Non-rusting casters

Item #460975
Mfg. #96975
Cs Pk 1 x 1 ea
Cs Wt 20.00 lb



BILINGUAL WET FLOOR SIGN

- Communicates warning message to help maintain safety

Item #460022
Mfg. #96991
Cs Pk 6 x 1 ea
Cs Wt 19.00 lb

Sold in case pack or eaches.





"WET FLOOR" CAUTION SIGN

- 26" high, yellow with English, Spanish, French and German imprint on both sides
- Easel style sign – all plastic with unique hinge to prevent over extension and pinching
- Folds flat for storage – hangs on most cleaning carts

Item #400785
Mfg. #119
Cs Pk 6 x 1 ea
Cs Wt 15.75 lb
Sold in case pack or eaches.



QUAD CONE CAUTION SIGN

- 35" high, nests for storage
- Universal warning symbols on all 4 sides
- Color: Yellow

Item #528279
Mfg. #222YW
Cs Pk 3 x 1 ea
Cs Wt 12.00 lb
Sold in case pack or eaches.



MAXIDUST™ COTTON CUT-END DUST MOP HEAD

- A great mop for dust control maintenance
- Heavy-duty, rust resistant snaps are fast and easy to use
- Yarn is made from traditional long, stapled, tightly twisted virgin natural cotton yarn • Easily laundered



Item #	Mfg. #	Description	Cs Pk	Cs Wt
380313	96024	24" x 5"	12 x 1 ea	12.00 lb
380319	96036	36" x 5"	12 x 1 ea	17.00 lb

Sold in case pack or eaches.



DUST MOP FRAMES

- 1/4" nickel plated steel rods
- Snap-on
- Janitorial grade

Item #	Mfg. #	Description	Cs Pk	Cs Wt
380326	96124	24" x 5"	12 x 1 ea	12.00 lb
380329	96136	36" x 5"	12 x 1 ea	17.00 lb

Sold in case pack or eaches.

SNAP-ON™ DUST MOP HANDLE

- 60", 5/16" diameter Firm-Grip™ ribbed metal handle
- Sliding collar locks handle into position for full 360° action

Item #380332
Mfg. #96161
Cs Pk 12 x 1 ea
Cs Wt 20.00 lb
Sold in case pack or eaches.



POLY WOOL DUSTERS

- Non-allergic polyester fiber attracts dust by electrostatic action
- Vivid multi colored
- Easily cleaned by washing and rinsing
- Extendable model for hard to reach areas
- Cs Pk 12 x 1 ea



Item #	Mfg. #	Description	Cs Wt
482657	280124	26"	5.00 lb
482658	280126	Extends 51" to 82"	12.00 lb

Sold in case pack or eaches.

LOBBY DUST PAN

- Black, high impact, plastic hopper with steel handle
- 12" wide collection bin for easy pick-up – bin locks to handle for carrying or hanging

Item #445567
Mfg. #912BK
Cs Pk 6 x 1 ea
Cs Wt 14.00 lb
Sold in case pack or eaches.



WIDE DUST PAN

- Heavy-duty 16" wide metal dust pan, ribbed for strength, powder coated for longer life
- Angled front edge • Handle hanger

Item #390237
Mfg. #716
Cs Pk 1 x 12 ea
Cs Wt 26.88 lb
Sold in case pack only.



DUST PAN

- 12" wide with hanger slot
- Black industrial plastic

Item #368515
Mfg. #712
Cs Pk 1 x 12 ea
Cs Wt 5.10 lb
Sold in case pack only.

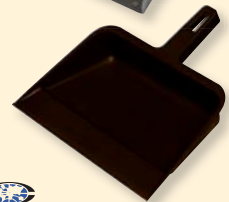

MAXICLEAN™ DUST PAN

- Thin front edge makes sweeping up particles easy
- 12" wide
- Plastic

Item #424877
Mfg. #96420
Cs Pk 12 x 1 ea
Cs Wt 8.79 lb
Sold in case pack or eaches.



LOBBY DUST PAN

- Durable rear wheels improve wear resistance
- Swivel pan w/T-bar locking feature
- High impact polypropylene
- 30" extruded aluminum handle

Item #421675
Mfg. #96208
Cs Pk 1 x 6 ea
Cs Wt 13.00 lb
Sold in case pack only.





CORN BROOMS

Deluxe Warehouse: Natural long lasting broomcorn, 14" sweeping surface with 1 1/8" varnished handle

Warehouse: Corn/Yucca blend, 12" sweeping surface with 1 1/8" diameter x 42" long black handle

Lobby: 100% natural broomcorn, 9" sweeping surface with 3/4" diameter x 30" long varnished handle

Item #	Mfg. #	Description	Cs Pk	Cs Wt
380243	6301-6	Deluxe Warehouse	1 x 6 ea	17.00 lb
380246	6120-6	Warehouse	1 x 6 ea	17.00 lb
427995	6200-6	Lobby	1 x 6 ea	7.00 lb

Sold in case pack only.

MAXICLEAN ANGLE BROOMS

- Flagged bristles sweep the finest particles
- Washable, sanitary fibers
- Firm-Grip™ metal ribbed handle
- Cs Pk 1 x 6 ea



Item #	Mfg. #	Description	Cs Pk	Cs Wt
380249	6400-6	Large Broom, 13" Sweeping Surface, 48" long Handle	1 x 6 ea	23.00 lb
427994	6208	Lobby Broom, 8 1/2" Sweeping Surface, 30" long Handle w/Swivel Hang Cap	1 x 6 ea	6.50 lb

Sold in case pack only.

MAXI-ANGLER® FLAGGED BROOM

- Flagged bristles sweep the finest particles
- Patented locking mechanism to secure handle
- 48" Firm-Grip™ metal ribbed handle
- 13" sweeping surface

Angle Broom	Replacement Head
Item #402102	Item #423520
Mfg. #91351	Mfg. #91282
Cs Pk 1 x 4 ea	Cs Pk 1 x 3 ea
Cs Wt 7.03 lb	Cs Wt 2.87 lb

Sold in case pack only.

MAXI-ANGLER® UNFLAGGED ANGLE BROOM

- Unflagged bristle prevents ends from matting together from grease
- Excellent for kitchen or rough surface floors
- 48" Firm-Grip™ metal ribbed handle
- 13" sweeping surface

Item #380252	Mfg. #91284
Cs Pk 1 x 4 ea	Cs Wt 7.03 lb

Sold in case pack only.



All Items This Page

STOP

Not Available via FedEx®.

#E502036

#E504028

#E503500

CLEAN SWEEP™ CORN BROOMS

- Corn fiber outer layer with stiff yucca fiber on the inside
- Warehouse or Janitor for industrial and janitorial sweeping
- Lobby broom is for spot cleaning

Item #	Mfg. #	Description	Cs Pk	Cs Wt
423878	E502036	Warehouse, 32#	1 x 6 ea	17.58 lb
431799	E504028	Janitor, 28#	1 x 6 ea	14.00 lb
431800	E502024	Housekeeper, 24#	1 x 6 ea	12.00 lb
431801	E503500	Lobby, 7#	1 x 12 ea	9.00 lb

Sold in case pack only.

LOBBY BROOM

- Stiff, flagged 4" polypropylene bristles
- 30" black metal handle

Item #431804	Mfg. #E503600
Cs Pk 1 x 6 ea	Cs Wt 7.00 lb

Sold in case pack only.

HUSKEE™ SWEEP

- Stiff, black flagged 6" polypropylene bristles
- 48" yellow metal handle w/grip brace
- Handle can be removed to use as a whisk broom

Item #431803	Mfg. #E515012
Cs Pk 1 x 6 ea	Cs Wt 12.00 lb

Sold in case pack only.

All Items This Page

STOP

Not Available via FedEx®.

ANGLED BROOMS

- Angled sweeps with flagged bristles
- 48" black metal handle with hanger hole

Item #	Mfg. #	Description	Cs Pk	Cs Wt
398332	E507008	9" Wide	1 x 12 ea	18.00 lb
431802	E507012	12" Wide	1 x 12 ea	20.00 lb

Sold in case pack only.

JANITORIAL



WALL TOOL HANGER

- Mop, broom and tool hanger made of high-impact plastic
- Patented rubber grips and tension adjustment
- Frees floor space – wet mops dry quicker when suspended
- Save time and end storage clutter
- 18" long • Color: Grey

Item #379925

Mfg. #516
Cs Pk 1 x 1 ea
Cs Wt 1.41 lb



#M109060 #M101060 #M105060

BRUSH & BROOM HANDLES

- Cs Pk 1 x 12 ea

Item #	Mfg. #	Description	Cs Wt
379808	M109060	Tapered Tip, Wood 1 1/8" x 60"	17.34 lb
379800	M101060	Threaded Tip, Wood – Standard threads 1 1/8" x 60"	12.94 lb
379803	M105060	Metal Threaded Tip, Wood 1 1/8" x 60"	19.11 lb

Sold in case pack only.



#F006124
#F007124

#F101124

PUSH BROOMS

- 24"w plastic block with 3" trim tampico or polypropylene bristles
- Uses threaded handle #379803 (sold separately)
- Cs Pk 12 x 1 ea

Item #	Mfg. #	Description	Cs Wt
379782	F006124	Fine, Tampico	28.32 lb
379790	F007124	Medium, polypropylene	28.21 lb
379793	F101124	Heavy duty, polypropylene	32.04 lb

Sold in case pack or eaches.

MULTI-LEVEL DECK BRUSH

- Blue polypropylene bristles (1 3/4" trim) in a 10" foam plastic block
- Uses threaded handle #379800 (sold separately)

Item #431805

Mfg. #1004000
Cs Pk 12 x 1 ea
Cs Wt 15.96 lb

Sold in case pack or eaches.



DECK BRUSH

- 10" wood block with polypropylene bristles (2" trim)
- Uses threaded #379800 or tapered #379808 handles (sold separately)

Item #399887

Mfg. #1001010
Cs Pk 12 x 1 ea
Cs Wt 11.90 lb

Sold in case pack or eaches.



BI-LEVEL BRUSH

- Scrubs baseboards and floors with one stroke, 11" long
- Washable polypro bristles prevent spread of germs
- Uses threaded #380504 handle (sold separately)



Item #380290

Mfg. #96619
Cs Pk 6 x 1 ea
Cs Wt 6.39 lb

Sold in case pack or eaches.



DECK SCRUB BRUSH

- 10" plastic block w/swivel joint
- Beige polypro bristles, 1" trim
- Uses threaded #380504 handle (sold separately)

Item #380259

Mfg. #96073
Cs Pk 12 x 1 ea
Cs Wt 10.00 lb

Sold in case pack or eaches.



PALMYRA DECK SCRUB BRUSH

- Stiff palmyra bristles • 10" block • 2" trim
- Uses threaded #380504 handle (sold separately)



Item #380257

Mfg. #96071
Cs Pk 12 x 1 ea
Cs Wt 16.00 lb

Sold in case pack or eaches.



JANITORIAL

MAXIPLUS™ HEAVY DUTY FLOOR SWEEP & HANDLE

- Extra firm red polypro bristles
- Patented E-Clip™ keeps handle from turning
- 60" long handle with Comfort-Grip™ and swivel hang cap



#96243



Item #	Mfg. #	Description	Cs Pk	Cs Wt
399849	96243	24" Broom Head	6 x 1 ea	16.00 lb
459538	97560	60" Metal Handle	12 x 1 ea	16.00 lb

Sold in case pack or eaches.



FIRM-GRIP™ PUSH BROOM HANDLE

- Extra thick ribbed steel with black vinyl coating and heavy gauge 1 1/8" diameter no-slip threaded steel tip
- 60" long with swivel hang cap

Item #380504

Mfg. #97160
Cs Pk 1 x 12 ea
Cs Wt 17.00 lb

Sold in case pack only.



3M™ DOODLEBUG™ SCRUB 'N STRIP PAD

- Designed for tough jobs like removing finish and wax buildup
- 4 7/8" x 10", brown

Item #369632

Mfg. #8541
Cs Pk 4 x 5 ea
Cs Wt 3.54 lb

Sold in case pack only.



SWIVEL PAD HOLDER W/UNIVERSAL LOCKING COLLAR

- Features "all direction" swivel action
- Universal locking collar uses threaded #379800 or #379803 handles (sold separately)
- Hooked base holds 4 1/2" x 10" cleaning pads

Item #482659

Mfg. #280137
Cs Pk 10 x 1 ea
Cs Wt 5.00 lb

Sold in case pack or eaches.



#8110 GY
#8114 GY



#8216 GY



"HUSKEE" BUCKETS

- Insulated hand grip with ample pour spout
- Resist acids, alkalines, chemicals and cleaning compounds
- Color: Grey

Item #	Mfg. #	Description	Cs Pk	Cs Wt
Molded Graduations Inside				
483703	8110GY	10 quart	12 x 1 ea	15.60 lb
483704	8114GY	14 quart	6 x 1 ea	11.40 lb
Divided Bucket				
484331	8216GY	16 quart	6 x 1 ea	14.28 lb

Sold in case pack or eaches.

#96818-S



#96823-S



FLOOR SQUEEGEES

- Unique moss rubber leaves floor dry to touch
- Acme threaded handle socket ensures secure handle fit
- Uses tapered handle #379808 (sold separately)

Item #	Mfg. #	Description	Cs Pk	Cs Wt
380292	96818-S	18" Moss	10 x 1 ea	5.50 lb
380295	96823-S	24" Curved	6 x 1 ea	11.02 lb

Sold in case pack or eaches.



STRAIGHT FLOOR SQUEEGEE

- Heavy metal frame and handle sockets – zinc plated for corrosion resistance
- Dual edge with long lasting high grade rubber blade
- Steel scraper for more thorough cleaning
- Uses tapered handle #379808 (sold separately)
- Cs Pk 2 x 1 ea



#2400

Item #	Mfg. #	Description	Cs Wt
398326	1800	18" Squeegee	4.00 lb
399889	2400	24" Squeegee	5.00 lb

Sold in case pack or eaches.

GROUT BRUSH

- Cleans grout from a standing position
- Swivel connector allows brush to glide along grout lines
- Uses tapered handle #379808 (sold separately)

Item #399851

Mfg. #96175
Cs Pk 6 x 1 ea
Cs Wt 3.00 lb

Sold in case pack or eaches.



KLEVER KUTTER™ BOX CUTTER

- Patent-pending design virtually eliminates costly cut injuries
- Eliminates handling troublesome & dangerous replacement blades
- Recessed blade prevents product damage
- Two-blade design provides long life; dishwasher safe



Item #465320

Mfg. #KK401
Cs Pk 1 x 3 ea
Cs Wt 0.04 lb

Sold in case pack only.



Smart + Safe + Sanitary

SPIRAL BOWL BRUSH

- Fully bristled head for superior scrubbing power
- White polypro bristles, 14" long

Item #464557

Mfg. #96301

Cs Pk 12 x 1 ea

Cs Wt 4.25 lb

Sold in case pack or eaches.



TWISTED WIRE BOWL BRUSH

- White polypro bristles, angled to reach under rim
- 17" long

Item #464558

Mfg. #96311

Cs Pk 12 x 1 ea

Cs Wt 4.35 lb

Sold in case pack or eaches.



TOILET BOWL BRUSH

- Non-staining, synthetic bristles resist common cleaning chemicals
- All plastic construction - acid resistant
- 15¼" long

Item #482656

Mfg. #280102

Cs Pk 24 x 1 ea

Cs Wt 41.00 lb

Sold in case pack or eaches.



DELUXE TOILET BOWL MOP

- Angled for easier reach
- Fuller head for greater absorbency
- Acid resistant fiber
- 12" long

Item #482655

Mfg. #280100

Cs Pk 12 x 1 ea

Cs Wt 1.80 lb

Sold in case pack or eaches.



WIRE BOWL BRUSH

- Angled head fits under the rim for thorough scrubbing
- Polyethylene fibers, wooden handle - natural
- 20" long

Item #379989

Mfg. #1507017

Cs Pk 1 x 12 ea

Cs Wt 4.01 lb

Sold in case pack only.



DELUXE PROFESSIONAL PLUNGER

- Bellow design moves more water with less effort - use for stubborn drains
- 21¼" O.A., 12" handle
- Black plastic construction
- Cleans up easily
- Splash-proof

Item #482661

Mfg. #280175

Cs Pk 12 x 1 ea

Cs Wt 10.00 lb

Sold in case pack or eaches.



INDUSTRIAL TOILET BOWL PLUNGER

- Designed for toilets and drains
- 17" heavy-duty plastic handle
- Large extended cup for best pressure application

Item #482660

Mfg. #280174

Cs Pk 24 x 1 ea

Cs Wt 23.00 lb

Sold in case pack or eaches.

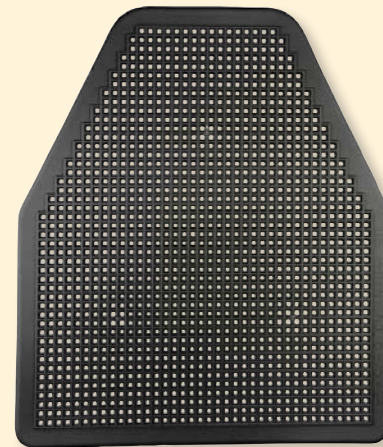

URINAL FLOOR MAT

- Saves money – protects floors from damaging uric acids that can stain floors
- Saves time – less urine on the floor reduces tracking of urine out of restroom and means less time cleaning the floor
- Long lasting – lasts up to 6 weeks depending on usage
- Fragrance free – no fragrance added to conflict with your odor control product
- Made of polypropylene
- 20½" x 17½"
- Color: Black

Item #499464

Mfg. #220200

Cs Pk 6 x 1 ea

Cs Wt 28.80 lb

Sold in case pack or eaches.



SANITARY NAPKIN RECEPTACLE

- Heavy gauge steel with flip top lid
- Door at base makes disposal quick and sanitary
- White enamel finish
- 11¼" x 8⅞" x 4⅞"

Receptacle
Item #400371
 Mfg. #250W-6
 Cs Pk 6 x 1 ea
 Cs Wt 21.96 lb



Disposable Paper Liners

- Wax coated Kraft paper, for #250
- 11¼" x 7½" x 3"

Item #379992
 Mfg. #250K
 Cs Pk 1/500 ea
 Cs Wt 8.00 lb
Sold in case pack only.



"DEOD-O-SCREEN" URINAL SCREEN

- With 30 day built-in deodorant
- Universal shape fits most urinals, 8" x 7½"
- Floral fragrance • Color: Blue

Item #500071
 Mfg. #164-1
 Cs Pk 1 x 1 dz
 Cs Wt 2.50 lb
Sold in case pack only.



URINAL KLEEN SCREEN™

- Dissolves uric salts, mineral deposits, and water scale
- Controls odors for 30 days
- Pine scent • Color: White

Item #489818
 Mfg. #165-2
 Cs Pk 1 x 12 ea
 Cs Wt 3.74 lb
Sold in case pack only.



TOILET SEAT COVERS

- Packed in 250 ct dispenser

Item #400560
 Mfg. #2100-4
 Cs Pk 4/250 ct
 Cs Wt 7.00 lb
Sold in case pack only.



CLEAR CHOICE™ URINAL DEODORIZER

- Fragrance is gradually released over 30 days
- VOC Compliant – no ozone depleting ingredients
- Design reduces splash back while optimizing fragrance release – cutting cleaning time
- Releases optimized bacteria that cleans the urinal and eliminates odors
- Shrinks in size as it releases beneficial bacteria and fragrance
- Made of proprietary polymer
- Herbal choice fragrance
- Color: Green • 7¾" w x 7¾" h

Item #531832
 Mfg. #220306
 Cs Pk 12 x 1 ea
 Cs Wt 2.00 lb
Sold in case pack or eaches.

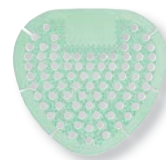

URINAL SCREENS W/BLOCK

- 30 day odor control
- Designed to prevent splash back
- 3 oz non-para detergent block
- 100% biodegradable
- Contains enzymes
- Cage keeps block above water level
- 6½" w x 7" l x 1½" h
- Cs Pk 6 x 1 dz • Cs Wt 23.00 lb



Item #	Mfg. #	Description
489482	220237	Cherry
489481	220238	Green Apple

Sold in case pack or dozens.

TOSS BLOCK

- Cleans, descales & deodorizes
- Biodegradable
- Long life non-para 3 oz block
- Contains enzymes

Item #482646
 Mfg. #220300
 Cs Pk 12 x 1 dz
 Cs Wt 32.00 lb
Sold in case pack or dozens.



DELUXE FLAT URINAL SCREENS

- 100% virgin vinyl
- Long lasting fragrance
- Fits most urinals
- Size: 8" w x 7" l
- Individually bagged with poly glove for sanitary removal

Bubblegum
Item #482642
 Mfg. #220170
 Cs Pk 1 x 1 dz
 Cs Wt 2.00 lb

Cherry
Item #482643
 Mfg. #220171
 Cs Pk 1 x 1 dz
 Cs Wt 2.00 lb



Bubblegum



Cherry

Sold in case pack only.

CLEARCHOICE™ AIR FRESHENER & DISPENSER

- Air freshener – twice as much fragrance as other air fresheners released over 30 days
- Easy-to-use – individually bagged
- VOC compliant – no ozone depleting ingredients
- Herbal Choice scent
- White dispenser



Item #	Mfg. #	Description	Cs Pk	Cs Wt
531834	220314	Dispenser	12 x 1 ea	24.00 lb
581833	220311	Air Freshener	1 x 6 ea	7.80 lb

Sold in case pack or eaches. ▼ Sold in case pack only.

KLEEN AIRE™ ROOM DEODORIZER CABINET

- Multi-function Kleen Aire cabinet with fan switch, L.E.D. light and sensor
- Uses D cell batteries (not included)
- 8¾" x 3¼" x 3"

Item #393202
Mfg. #NI101MF
Cs Pk 24 x 1 ea
Cs Wt 22.80 lb
Sold in case pack or eaches.



KLEEN AIRE™ NEUTRALIZER GEL

- Organic fragrance attacks and neutralizes odors anywhere they occur
- Garden apple fragrance

Item #379972
Mfg. #105
Cs Pk 1 x 1 dz
Cs Wt 12.00 lb
Sold in case pack only.



KLEEN TECH NAUTICAL FRAGRANCE

- With universal actuator
- Dual odor counteractants
- 7 oz aerosol can

Item #408968
Mfg. #1182
Cs Pk 1 x 12 ea
Cs Wt 8.64 lb
Sold in case pack only.



BULK SOAP DISPENSER

- 30 oz capacity, accommodates a wide variety of liquid and lotion soaps (except pumice)
- Large push bar for easy dispensing
- Meets ADA regulations
- 6½" h x 4½" w x 4½" d • Color: Black Pearl

Item #539382
Mfg. #S30TBK
Cs Pk 6 x 1 ea
Cs Wt 5.20 lb
Sold in case pack or eaches.



CLEARCHOICE™ PLASTIC SOAP DISPENSER

- Large 50 oz (1.48 L) capacity - see-thru tank
- Modern design is easily cleaned
- Compatible with a wide selection of liquid or lotion soaps (not for use with abrasive soaps)
- Dispenses approximately 1 cc of soap
- Push bar is ADA compliant
- 6½" w x 8¾" h x 4" d

Item #482651
Mfg. #230155
Cs Pk 12 x 1 ea
Cs Wt 21.00 lb
Sold in case pack or eaches.



OCEANS® SOAP DISPENSER

- 800 mL capacity, bulk or bag-in-box cartridges
- 10½" h x 4½" w x 4¾" d
- Color: Black Pearl

Item #458153
Mfg. #S890TBK
Cs Pk 6 x 1 ea
Cs Wt 10.50 lb
Sold in case pack or eaches.



OCEANS® JBT DISPENSER

- Universal, dispenses any brand 10½" jumbo bath tissue
- 14" h x 12½" w x 5½" d
- Color: Black Pearl

Item #414146
Mfg. #R2790TBK
Cs Pk 1 x 1 ea
Cs Wt 14.30 lb



CLASSIC TWIN JBT DISPENSER

- Sliding panel prevents access to spare roll until needed
- Transparent black full-swing replaceable cover
- Break-resistant plastic
- Holds two 9" jumbo rolls
- 12" h x 19" w x 5¼" d
- Color: Black Pearl

Item #380921
Mfg. #R4000TBK
Cs Pk 4 x 1 ea
Cs Wt 20.00 lb
Sold in case pack or eaches.





Single



Double

METAL TISSUE DISPENSERS

- Heavy-duty 18 gauge chrome metal construction
- Will accommodate many sizes of roll tissue
- Pilfer-proof locking device
- Tension spring prevents free unrolling of paper

Item #	Mfg. #	Description	Cs Pk	Cs Wt
482647	230100	Single, 2¾" x 6" x 4¾"	6 x 1 ea	4.30 lb
482648	230101	Double, 2¾" x 11" x 4¾"	6 x 1 ea	8.30 lb

Sold in case pack or eaches.

SAVVY® OCEANS® LEVER ROLL DISPENSER

- Auto transfer device allows complete usage of stub roll, Bio-Pruf® treated handle resists bacterial growth
- Holds 8" w x 8½" diameter roll and up to 4" diameter stub roll
- 15¾" h x 13" w x 9¾" d
- Break-resistant plastic
- Color: Black Pearl

Item #389734
Mfg. #T1290TBK
Cs Pk 1 x 1 ea
Cs Wt 8.70 lb



OCEANS® ULTRAFOLD™ PRESENT® TOWEL DISPENSER

- 14¾" h x 12½" w x 5½" d
- Dispenses C-fold or multi-fold towels
- Break-resistant plastic
- Holds 450 C-fold or 750 multi-fold towels
- Color: Black Pearl

Item #389735
Mfg. #T1790TBK
Cs Pk 5 x 1 ea
Cs Wt 22.00 lb

Sold in case pack or eaches.



UNIVERSAL LEVER ROLL TOWEL DISPENSER

- Bio-Pruf® treated handle
- Break-resistant plastic
- Stub roll compartment
- Holds 8" w x 8½" diameter roll and up to 4" diameter stub roll
- 16½" h x 12½" w x 9¼" d

Item #389733
Mfg. #T1100WH
Cs Pk 1 x 1 ea
Cs Wt 7.90 lb



MULTI & C-FOLD TOWEL CABINET



- Accommodates multi-fold or C-fold towels
- Tamper proof hinged, top locking, with see-thru gauge
- Heavy gauge chrome finish steel
- 15¾" x 11¼" x 4½"

Item #459532
Mfg. #991C
Cs Pk 6 x 1 ea
Cs Wt 38.52 lb

Sold in case pack or eaches.



METAL TOWEL CABINETS

- White enamel on steel
- Key locking for security



- Holds two packages of single-fold or junior towels
- 8" x 10½" x 6¾"

Item #482649
Mfg. #230108
Cs Pk 6 x 1 ea
Cs Wt 28.00 lb

Sold in case pack or eaches.



- Combination towel cabinet for C-fold or multi-fold towels
- 15¾" x 11¼" x 4½"

Item #482650
Mfg. #230109
Cs Pk 6 x 1 ea
Cs Wt 41.00 lb

Sold in case pack or eaches.



#160107



#160162

PLASTIC BOTTLE PUMPS

- Plastic jug pump delivers 1 oz per stroke
- 38/400 adaptor fits 1 gallon bottles
- Plunger locks down for shipping and storage
- 11" dip tube, color white
- Polypropylene with stainless steel spring
- Excellent for soaps, lotions, chemical concentrates

Item #	Mfg. #	Description	Cs Pk	Cs Wt
482640	160107	Pump w/ 38, 89, 110 & 120/400 adaptors	6 x 1 ea	2.20 lb

482639▼160162 Pump 1 x 1 dz 2.40 lb
▼Sold in case pack only. Sold in case pack or eaches.



3-PACK VALU-CHECK SPRAYERS

- Three 32 oz bottles & model 220 trigger sprayers
- Molded oz/mL graduation and dilution scales
- Bilingual (English/Spanish) imprint includes product check off ID and safety information

Item #482638
Mfg. #130136
Cs Pk 24 x 3 ea
Cs Wt 19.00 lb
Sold in case pack or eaches.



ASPEN SAFETY GLASSES

- Molded from 100% clear polycarbonate
- Wide vision wrap-around style with molded-in comfort nose bridge and vented sideshields
- Fits over most prescribed eyewear
- Meets ANSI Z89.1-2003 standards



Item #482666
Mfg. #320134
Cs Pk 12 x 1 ea
Cs Wt 1.50 lb
Sold in case pack or eaches.

PROSAFE™ SPRAYERS 3-PACK

- Adjust-O-Spray trigger sprayers attached to 24 oz plastic bottles are packed in a see-thru poly bag
- Screened with a product check-off grid and safety information
- Bilingual – English/Spanish

Item #499084
Mfg. #902-3RW
Cs Pk 32 x 3 ea
Cs Wt 21.00 lb
Sold in case pack or eaches.



ALL-PURPOSE SCOOP

- Polypropylene with protected handle
- For dry or liquid chemicals
- 3 quart, white
- 6" w x 6" d x 14½" h

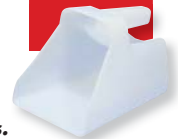

Item #482652
Mfg. #240103
Cs Pk 12 x 1 ea
Cs Wt 7.00 lb
Sold in case pack or eaches.

JANITORIAL



CONTEMPORARY SYMBOL SIGNS



- Complete information and directional signage system with international symbols
- Pressure sensitive adhesive backing for easy mounting
- 3" x 9" sign, white on black
- Cs Pk 1 x 1 ea • Cs Wt 0.20 lb

Item #	Mfg. #	Message
486754	4506	"Employees Only"
486755	4513	"No Smoking"
486756	4515	"Men"
486757	4516	"Women"
486758	4517	"Restrooms"
486759	4521	"Thank You For Not Smoking"
486760	4523	"No Pets/Shoes, Shirt Required"
486761	4530	"Employees Must Wash Hands Before Returning to Work"



BLOODBORNE PATHOGEN CLEAN-UP KIT

- Safe and sanitary clean-up of bodily fluids, blood and potentially infectious material
- Meets OSHA bloodborne pathogens final rule 29 CFR 1910.1030
- Contains no bleach to stain carpet, wood or tile flooring
- Kit contains:
 - 3 oz pack of solidification powder (absorbs 120 times its weight and instantly solidifies liquid), pair protective latex gloves, protective face shield, disposable isolation mask, pair shoe covers (non-skid), apron (fluid resistant), absorbent towel, two scoops and scrapers for easy cleanup, two antiseptic disinfecting towelettes, two disposable red biohazard bags w/twist ties,
 - 12 oz spray disinfectant, instruction and material safety data sheets

Item #482665
Mfg. #320100
Cs Pk 6 x 1 ea
Cs Wt 11.00 lb
Sold in case pack or eaches.





A-19



BR Reflector



BR 40



Single Pin

F-40

Bi Pin



LIGHT BULBS

• Commercial grade bulbs, lamps and fluorescents to meet the special needs of foodservice

Item #	Mfg. #	Description	Cs Pk	Cs Wt
Incandescent A-19 Long Life Bulbs – 2,000 hrs, Frosted, 120V				
380532	16683	60 watt, Med. Base, 60A19	1 x 24 ea	3.00 lb
380558	16685	75 watt, Med. Base, 75A19	1 x 24 ea	3.00 lb
380559	16687	100 watt, Med. Base, 100A19	1 x 24 ea	3.00 lb
Incandescent BR Reflector Lamp – 2,000 hrs, Flood, 120V				
388037	00156	65 watt, Med. Base, 65BR30	1 x 24 ea	7.00 lb
Infrared Heat Lamps BR-40 – 6,000 hrs, 120V				
380565	17526	250 watt, Clear, Med. Base, 250BR40/1	1 x 3 ea	1.00 lb
380566	17527	250 watt, Red Pyrex, Med. Base, 250BR40/10/WP	1 x 3 ea	1.00 lb
494216	03509	250 watt, Coated, Clear, Med. Base, 250BR40/1/CL/TC/HI-TEMP	1 x 12 ea	4.00 lb
Ener-Gee Save Fluorescent Bulbs – F-40 Style – Cool White				
380992	30534	34 watt, 48" long, Med. Bipin, 20,000 hrs, F40T12CW/ES	1 x 6 ea	5.00 lb
380579	30530	34 watt, 48" long, Med. Bipin, 20,000 hrs, F40T12CW/ES	1 x 30 ea	18.50 lb
380585	30545	60 watt, 96" long, Single Pin, 12,000 hrs, F96T12CW/ES	1 x 15 ea	22.00 lb
Mini Lynx Integrated Spiral Compact Fluorescent Bulb – 10,000 hrs, Med. Base				
483193	26158	20 watt, 5.70" long, 20MLS/827	1 x 10 ea	3.29 lb



Frosted Candle



20 W

Sold in case pack only.

COMMERCIAL KITCHEN LIGHTING

The right lighting is absolutely key for commercial kitchens, which must meet rigorous standards of cleanliness, as well as cooking appealing foods. Besides providing a clear view of the food being cooked, good lighting also helps prevent injuries, such as cuts and burns. Most commercial kitchen lighting relies on large fluorescent fixtures for general light, and track lighting for task areas. In many restaurant kitchens, these are utilitarian fixtures, but in some restaurants part of the experience is being able to see the chefs at work. If the kitchen is visible to the guests, kitchen light fixtures should be in keeping with the overall decor of the establishment.

JANITORIAL



BABY COMFORT OASIS DIAPER CHANGE STATION

- Non-porous polyethylene is easy to keep sanitary and will not absorb moisture or odors
- Smooth texture and softly rounded corners allow for easy cleaning and safety
- Conforms to ADA Article 4.4.1 (projects only 4" from the wall when closed)
- Molded-in dual liner dispenser accommodates approximately 50 plastic lined bed liners
- Concave bed and deep side walls provide a safe surface for changing
- Contoured bag hooks, one for purse and one for diaper bag
- Hinge system supports 250 lb static load
- Heavy-duty safety straps for child security
- Bilingual user friendly instructions • Includes installation parts
- Color: White

Item #455160

Mfg. #8252-H

Cs Pk 1 x 1 ea

Cs Wt 16.80 lb



CHAFING FUEL & CHAFER SET



Not Available via FedEx®.

BLAZE
Trusted by top chefs

CHAFING FUEL

- Both jelled and liquid formulations are guaranteed
- Provides optimum flame and heat spread
- Increased burn time and constant temperatures
- All fuels are sustainable and environmentally friendly
- ISO 9000 Certified, Kosher Approved



#BB100



#GB100



#LB300

#SB700

#GB100

#LB300



#CW300



#CW300
"stackable"

Item # Mfg. # Description

Jelled Ethanol Fuel

181673 BB100 2 hr Burn Time

520604 BB400 45 min Burn Time

Jelled Methanol Fuel

181666 GB100 2 hr Burn Time

181698 GB200 1 Gallon Refill

Liquid Diethylene Glycol Fuel

398476 CW300 Clear Wick, 5½ hr Burn Time, Stackable

181709 LB300 Liquid Blaze, 5½ hr Burn Time, Twist Top

533487 LB700 Liquid Blaze, 4 hr Burn Time, Twist Top

345744 SB700 Liquid Blaze, 4 hr Burn Time, Screw Cap

Cs Pk Cs Wt

1 x 72 ea 35.80 lb

1 x 144 ea 29.00 lb

1 x 72 ea 35.80 lb

4 x 1 gal 32.10 lb

1 x 24 ea 15.90 lb

1 x 24 ea 14.20 lb

1 x 24 ea 13.00 lb

1 x 24 ea 13.80 lb

Sold in case pack only.



#GB200



NET WT. 8 LBS. 14 OZ.

CHAFING FUEL



Not Available via FedEx®.

STERNO
GROUP

Item # Mfg. # Description

367959 ST05006 2 hr Stem Wick Chafing Fuel

367921 ST05010 4 hr Twist Cap Wick

367902 ST03009 6 hr Stem Wick

406939 ST05008 6 hr Stem Wick

458303 ST05009 6 hr Stem Wick

Sterno® Brand Hot Spot® SuperWick® Chafing Fuel

367905 ST05016 4 hr

487134 ST05017 4 hr, Resealable Lid

Sterno® Brand Gel Chafing Fuel

367942 ST04006G 45 min Gel

458302 ST04043 2 hr Gel

367901 ST04008G 2 hr Gel

367972 ST04028 1 Gallon Gel Refill

Handy Wick® Brand Chafing Fuel

409315 HW03002 2 hr Twist Cap Wick

409316 HW03004 4 hr Twist Cap Wick

409317 HW03006 6 hr Twist Cap Wick

Handy Fuel® Brand Gel Chafing Fuel

368007 HF03003 45 min Gel

367903 HF03008 2 hr Gel

378937 HF03007 1 Gallon Gel Refill

367910 HF03108 2 hr Gel, Pennsylvania Formula

Sold in case pack only.

Cs Pk Cs Wt

1 x 24 ea 6.80 lb

1 x 24 ea 12.60 lb

1 x 24 ea 16.10 lb

6 x 4 ea 15.50 lb

1 x 12 ea 7.40 lb

1 x 24 ea 18.10 lb

1 x 24 ea 18.90 lb

1 x 144 ea 28.00 lb

1 x 12 ea 8.30 lb

1 x 72 ea 39.30 lb

1 x 4 ea 31.40 lb

1 x 24 ea 7.20 lb

1 x 24 ea 12.80 lb

1 x 24 ea 18.00 lb

1 x 144 ea 32.80 lb

1 x 72 ea 39.10 lb

1 x 4 ea 31.00 lb

1 x 72 ea 39.10 lb

DISPOSABLE/CHEMICAL



#ST05016



#ST05017



#ST05006



#ST04028



#ST05010



#ST04008G



#ST03009



#HW03002



#HW03006



#HW03004



#HF03007



#HF03003



#HF03008



POP-UP CHAFER SET

- Includes: metal pan holder, reusable aluminum water pan, 2 half food pans, 1 plastic serving spoon and fork set and 2 cans of Sterno 2 hour gel chafing fuel
- Fold-down frame • Durable construction store, set up and serve over and over again
- Utilizes standard aluminum foil pans

Item #514407

Mfg. #STO7000

Cs Pk 1 x 4 ea

Cs Wt 16.50 lb

Sold in case pack only.

STERNO
GROUP

DURACELL® COPPER TOP BATTERIES

- Don't buy just any old battery – look to the copper top for a long-lasting, powerful dependable battery – look to Duracell®

Item #	Mfg. #	Description	Cs Pk	Cs Wt
444650	09261	"AA" Batteries, 2 Pk	4/14 ct	7.95 lb
444651	03561	"AA" Batteries, 4 Pk	4/14 ct	14.20 lb
444653	15261	"AAA" Batteries, 2 Pk	3/18 ct	4.10 lb
444655	04061	"AAA" Batteries, 4 Pk	3/18 ct	6.80 lb
444649	09161	"C" Batteries, 2 Pk	6/8 ct	17.40 lb
444648	09061	"D" Batteries, 2 Pk	8/6 ct	33.90 lb
444652	09361	9 Volt Batteries, 1 Pk	4/12 ct	12.91 lb

Sold in case pack only.



#03561



#09061

Procter&Gamble
Professional™

GUEST CHECKS

- GuestCheck™ guest checks
- Color: Green



#G3616

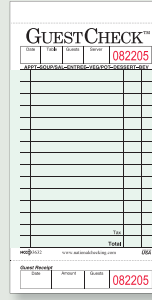

#G3632



#G6000



#G7000

Item #	Mfg. #	Description	Lines	Size	Checks/Bk	Cs Pk	Cs Wt
412446	G3616	1 Part Paper	16	3½" x 6¾"	100	50/100 ct	11.00 lb
412447	G3632	1 Part Carboard	15	3½" x 6¾"	50	50/50 ct	12.00 lb
412450	G6000	2 Part Duplicate Interleaving Carbon	17	3½" x 6¾"	50	50/50 ct	11.00 lb
412451	G7000	2 Part Carbonless	17	3½" x 6¾"	50	50/50 ct	12.00 lb

Sold in case pack only.



#1441SP



#7225-80SP



REGISTROLL® REGISTER ROLLS

Item #	Mfg. #	Size	Cs Pk	Cs Wt
1 Ply, White Bond				
412458	1441SP†	44mm x 165'	5/10 ct	16.00 lb
412456	1300SP†	3" x 165'	3/10 ct	15.00 lb
1 Ply, Thermal, White Bond				
442526	7225-80SP†	2.25" x 80'	2/24 ct	10.00 lb
385779	7225SP†	2.25" x 200'	4/10 ct	18.00 lb
374617	7313SP†	3.13" x 200'	3/10 ct	18.00 lb
Carbonless 2 Ply, White/Canary				
412460	2300SP†	3" x 100'	3/10 ct	16.00 lb

Sold in case pack only. † Rolls packaged in shrink wrapped trays.



#2300SP

DISPOSABLE/CHEMICAL

STEAM TABLE PAN

- Foil with full curl rim
- Full size, 232 fl oz
- 20¾" x 12¾" Top Out, 19¾" x 11¾" Top In, 17¾" x 9¾" Bottom, 2¾"d Vertical



Item #476129
Mfg. #4020-70-50
Cs Pk 50/1 ea
Cs Wt 14.00 lb
Sold in case pack or eaches.



#11205

#51805

#51808



HANDI-FOIL® FOOD SERVICE ROLL FOIL

- Cs Pk 1 x 1 ea

Item #	Mfg. #	Description	Cs Wt
476077	11205	Standard, 12" x 1000'	8.14 lb
476079	51805	Standard, 18" x 500'	6.14 lb
476080	51808	Heavy-Duty, 18" x 500'	9.10 lb

KENKUT® 3 DISPENSER FOR FILM OR FOIL

- Accommodates 12" to 18" rolls up to 3,000 feet
- Eliminates cross-contamination
- Integrated handles for easy transportation
- Nonslip feet or wall mountable
- For front-of-the-house, open kitchens or sushi bars
- Dishwasher safe
- 8½"w x 20"l x 7"l



Item #506616
Mfg. #KK3
Cs Pk 1 x 1 ea
Cs Wt 4.00 lb

HOT DOG TRAY

- 8"

Item #397196
Mfg. #HDT-8M
Cs Pk 6/500 ct
Cs Wt 14.00 lb

Sold in case pack only.



INTERFOLDED DRY WAXED "FOOD WRAP"

- Medium grade
- Used for basket liners, scale sheets, sandwich wraps, sub and hamburger wraps and portion control dividers
- Microwaveable

Item #	Mfg. #	Description	Cs Pk	Cs Wt
388936	FW-12	12" x 10¾"	6/500 ct	39.33 lb
388937	FW-15	15" x 10¾"	12/500 ct	51.04 lb

Sold in case pack only.



#EZ-12

#EZ-8

INTERFOLDED DRY WAXED "EZ WRAP"

- Light grade
- Used for basket liners, scale sheets, sandwich wrap, sub and hamburger wrap and portion control divider
- Microwaveable
- Cs Pk 12/500 ct

Item #	Mfg. #	Description	Cs Wt
388933	EZ-8N	8" x 10¾"	23.53 lb
388931	EZ-12N	12" x 10¾"	34.47 lb

Sold in case pack only.

BAKING PAN LINER

- Quick easy release
- Quilon treated
- Used primarily for breads, cookies and buns



16 1/8" x 24 3/8"
Item #388944
Mfg. #PL-25-1
Cs Pk 1/1000 ct
Cs Wt 24.00 lb
Sold in case pack only.

PAPER FILTERS

- Economical
- Delivers that same great tasting cup of coffee to your customers, every time



BUNN

Item #	Mfg. #	Description	Cs Pk	Cs Wt
For 12-cup Brewers				
343748	20122.0000	Regular Fast Flow 1M, 500/Bag, 2 Bags/Case, 50/Cluster	2/500 ct	5.00 lb
For 8-cup Brewers				
289574	20106.0000	A10 1M, 500/Bag, 2 Bags/Case, 50/Cluster	2/500 ct	4.00 lb
For 6-Gallon Urns				
289617	20125.0000	6 Gallon, 21" x 9", 252/Case, 36/Cluster	1/250 ct	9.50 lb
For Bunn® Iced Tea Brewers, Single/Dual Coffee Brewers, and 1½ Gallon Urns				
288807	20100.0000	Tea, SYS2 500 Pack, 12¾" x 5¼", 250/Bag, 2 Bags/Case, 50/Cluster	1/500 ct	6.00 lb

Sold in case pack only.

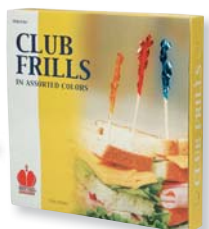

FRILL TOOTHPICKS

- Wooden picks

3" Regular Frills
Item #400532

Mfg. #1001-1
Cs Pk 10/1000 ct
Cs Wt 5.00 lb

Sold in case pack only.

4" Club Frills
Item #400533

Mfg. #1002-1
Cs Pk 10/1000 ct
Cs Wt 7.50 lb

Sold in case pack only.



#10036

#1004-1

#1005-1

TOOTHPICKS

Item #	Mfg. #	Description	Cs Pk	Cs Wt
400534	10036	2¼" Round Toothpicks	24/800 ct	6.00 lb
400535	1005-1	2¼" Ind. Cello (Mint) Wrapped	12/1000 ct	5.00 lb
407173	1004-1	Individual, Cello Wrapped Plain	12/1000 ct	5.00 lb

Sold in case pack only.

PARTY PICKS

- Parasol picks (assorted colors)

Item #400555

Mfg. #1013-6
Cs Pk 10/144 ct
Cs Wt 3.50 lb

Sold in case pack only.



SWORD PICKS

- Neon, assorted colors

Item #400544

Mfg. #2001-1
Cs Pk 10/1000 ct
Cs Wt 11.00 lb

Sold in case pack only.



#2001-1



COFFEE STIRRERS

- Wooden with round ends
- 7½" long

Item #402998

Mfg. #1087-1
Cs Pk 10/500 ct
Cs Wt 15.00 lb

Sold in case pack only.



PAPER PLATES

- Color: White

Green Label

- Uncoated • .010 pt

Item #	Mfg. #	Description	Cs Pk	Cs Wt
458277	PP9GREWH	9" diameter	10/100 ct	16.00 lb
458279	PP9GRAWH	9" diameter	12/100 ct	19.00 lb
458280	PP6GREWH	6" diameter	10/100 ct	8.00 lb

Bulk Pack

- Uncoated • .010 pt

Item #	Mfg. #	Description	Cs Pk	Cs Wt
458281	PP9BUKWH	9" diameter	1/1000 ct	16.00 lb
458283	PP6AJKWH	6" diameter	1/1000 ct	8.00 lb

Sold in case pack only.



DISPOSABLE/CHEMICAL

DOILIES

- Elegant and economical French Lace design

Item #	Mfg. #	Description	Cs Pk	Cs Wt
399417	D301015	5" diameter	10/1000 ct	20.00 lb
399418	D301016	6" diameter	10/1000 ct	26.00 lb
399419	D301018	8" diameter	10/500 ct	25.00 lb
399420	D3010110	10" diameter	10/500 ct	36.00 lb
399421	D3010112	12" diameter	10/500 ct	47.00 lb

Sold in case pack only.



PLACEMATS

- Upscale your operation without spending a fortune
- The assorted range of colors and styles are sure to match any decor
- Cs Pk 1 x 1000 ct



#PP37640



#PM32052

Item #	Mfg. #	Description	Cs Wt
Stocked Printed			
399510	PP37640	Gold Greek Key, 9½" x 13½", Straight Edge	10.00 lb
Embossed			
399507	PM30659	Anniversary, Straight Edge, 10" x 14", White	10.00 lb
399504	PM32051	Belfast, Straight Edge, 10" x 14", White	9.00 lb
399506	PM32052	Knurl, Scalloped Edge, 9¾" x 13¾", White	9.00 lb

Sold in case pack only.



#PM30659



VALUGARDS ECONOMY DISPOSABLE GLOVES

- Available in powdered or powder-free
- Wrist length • Rolled cuffs • Cs Pk 10/100 ct

Item #	Mfg. #	Description	Cs Wt
Vinyl - Clear			
488649	304340172	Medium, Powdered	13.65 lb
488650	304340173	Large, Powdered	17.12 lb
484341	304340182	Medium, Powder-Free	14.39 lb
484342	304340183	Large, Powder-Free	16.56 lb
Latex - Ivory			
488679	304750142	Medium, Powder-Free	14.66 lb
488680	304750143	Large, Powder-Free	15.72 lb

Sold in case pack only.

Handgards® INC.

DISPOSABLE/CHEMICAL

DISPOSABLE GLOVES

- All of our foodservice gloves are produced in factories that are ISO 9002 certified, registered with United States FDA and follow ASTM and GMP standards
- Our foodservice gloves are manufactured with USDA approved materials that comply with FDA 21 CFR 177.2600 for food handling

Latex Gloves

- Wrist length with beaded cuff

Item #	Mfg. #	Size	Cs Pk	Cs Wt
387556	NMLX102	Medium	10/100 ct	14.00 lb
387557	NMLX103	Large	10/100 ct	15.00 lb

Sold in case pack only.

Latex Gloves, Powder Free

- Wrist length with beaded cuff

Item #	Mfg. #	Size	Cs Pk	Cs Wt
387562	NMPF102	Medium	10/100 ct	15.00 lb
387563	NMPF103	Large	10/100 ct	16.00 lb

Sold in case pack only.



#NMPF



CAN LINERS

- High density, natural

Item #	Mfg. #	Description	Cs Pk	Cs Wt
406707	C242406N	24" x 24", 6 Micron, 7-10 Gallon	20/50 ct	9.70 lb
406706	C243306N	24" x 33", 6 Micron, 12-16 Gallon	20/50 ct	12.50 lb
406701	C243308N	24" x 33", 8 Micron, 12-16 Gallon	20/50 ct	16.90 lb
406703	C303710N	30" x 37", 10 Micron, 20-30 Gallon	20/25 ct	14.90 lb
406710	C334011N	33" x 40", 11 Micron, 33 Gallon	20/25 ct	19.50 lb
406708	C334016N	33" x 40", 16 Micron, 33 Gallon	10/25 ct	14.00 lb
407179	C366017N	36" x 60", 17 Micron, 55 Gallon	8/25 ct	19.60 lb
406704	C386014N	38" x 60", 14 Micron, 60 Gallon	8/25 ct	17.20 lb
406697	C386017N	38" x 60", 19 Micron, 60 Gallon	8/25 ct	20.70 lb
406702	C404812N	40" x 48", 12 Micron, 40-45 Gallon	10/25 ct	15.50 lb
406699	C404816N	40" x 48", 16 Micron, 40-45 Gallon	10/25 ct	20.40 lb
406705	C434816N	43" x 48", 16 Micron, Glutton	8/25 ct	17.60 lb

Sold in case pack only.



GROCERY BAGS

- Kraft • Cs Pk 1/500 ct



Item #	Mfg. #	Description	Cs Wt
459092	GB02NP5C	2# Natural	5.00 lb
459093	GB04NP5C	4# Natural	8.00 lb
459095	GB06NP5C	6# Natural	11.00 lb
459096	GB08NP5C	8# Natural	13.00 lb
459097	GB10NP5C	10# Natural	15.00 lb
459098	GB12NP5C	12# Natural	20.00 lb
459099	GB16NP5C	16# Natural	26.00 lb
459108	SQ40NP5C	20# Squat, Natural	25.00 lb
459109	SQ40NP5C25	25# Squat, Natural	27.00 lb
459091	GS57NP5C	57# Natural	54.00 lb
462402	WB02NP5C	2# Bleached	5.00 lb
459114	WB04NP5C	4# Bleached	8.00 lb
459117	WB06NP5C	6# Bleached	11.00 lb
459122	WB08NP5C	8# Bleached	13.00 lb
459123	WB10NP5C	10# Bleached	15.00 lb
459124	WB12NP5C	12# Bleached	20.00 lb
459125	WB16NP5C	16# Bleached	26.00 lb
460610	LP35NP5C	Pint, Liquor, Natural	7.00 lb
460613	LQ35NP5C	Quart, Liquor, Natural	10.00 lb

Sold in bale only.



T-SHIRT BAGS

- Plain or imprinted
- 11½" x 6½" x 21"
- Color: White



#11-10093

#11-10096/#11-10395

Item #	Mfg. #	Description	Cs Pk	Cs Wt
446488	11-10093	13 microns, Plain, No Imprint	1/1000 ct	11.75 lb
446487	11-10096	13 microns, Imprinted w/Thank You	1/1000 ct	11.75 lb
484261	11-10395	10 microns, Imprinted w/Thank You	1/975 ct	9.00 lb
485935	11-10496	17 microns, Imprinted w/Thank You	1/720 ct	11.75 lb

Sold in case pack only.

E-Z TOTE HANDLE SACK

- EZ tote handle sacks, 70# natural kraft



Shown with optional print. Special print request, price to be determined based on size and quantities.

Item #459090
Mfg. #HS70NP3C
Cs Pk 1/300 ct
Cs Wt 45.00 lb
Sold in bale only.

SHORTENING FILTERS

Automatic Filter Sheets

Item #	Mfg. #	Description	Model	Cs Pk	Cs Wt
431898	D1217S3	12½" x 17¾"	Frymaster	1/100 ct	2.50 lb
431903	D1324S5	13½" x 24"	Pitco/Frialator	1/100 ct	9.75 lb
431901	D1618S4	16¾" x 18¾"	Dean	1/100 ct	7.75 lb
431899	D1624S4	16¾" x 24¾"	Dean	1/100 ct	9.75 lb
431904	D1625S3	16½" x 25½"	Frymaster	1/100 ct	5.00 lb
502609	D1724S4	17½" x 24"	Pitco/Frialator	1/100 ct	14.50 lb
436573	D1728S5	17½" x 28"	Pitco/Frialator	1/100 ct	15.00 lb

Automatic Filter Envelopes

431900	D1422E3	14" x 22" w/1½" Hole	Henny Penny	1/100 ct	6.00 lb
443868	D1722E4	16¾" x 22½" w/¾" Hole	Collectromatic/Winston	1/100 ct	18.00 lb
436575	D1820E5	18½" x 20½" w/1½" Hole	Pitco/Frialator	1/100 ct	23.00 lb

Automatic Filter Disc

431910	D2178D4	21¾" diameter w/1½" Hole	Prince Castle	1/100 ct	9.25 lb
--------	---------	--------------------------	---------------	----------	---------

Manual Filter and Holder

385446	FC-10-3	10" Filter Cone	Manual	10/50 ct	9.00 lb
436193	FCH-10-1	10" Holder for Filter Cone	Manual	1/1 ct	2.00 lb

Sold in case pack only.



DISPOSABLE/CHEMICAL

CARBON-OFF!® DEGREASER

- Heavy duty carbon grease remover
- Works quick and easy saving time and labor
- Liquid is "Brush On - Wipe Off" for heavy build up
- Aerosol is "Spray On - Wipe Off" for light to medium build-up
- Safe on aluminum!

Item #	Mfg. #	Description	Cs Pk	Cs Wt
398269	10619	Aerosol	6/19 oz	10.00 lb
398270	10919	Aerosol	9/19 oz	15.00 lb
398271	11219DC	Aerosol	12/19 oz	20.00 lb
398272	10632	Liquid	6/1 qt	17.00 lb
398273	10101	Liquid	1/1 gal	10.00 lb
398274	10102	Liquid	2/1 gal	20.00 lb

Sold in case pack only.



FRYER PUCK™ BOIL OUT CLEANER

- Heavy duty, concentrated high alkaline detergent formulated to meet the toughest cleaning jobs
- Excellent cleaning capacity and high soil, fat and grease tolerance
- Low foaming 4 oz tablets
- Specially formulated for all fryers and pressure cookers

Item #400886

Mfg. #40130-4

Cs Pk 30/4 oz

Cs Wt 8.00 lb

Sold in case pack only.



#521390

#521389

#521388

SHEILA SHINE®

- Three steps in one: clean, polish and protect
- Removes greasy film, finger prints, streaking and water marks
- Prevents liquid penetration
- Helps preserve beauty of stainless steel, aluminum, chrome, brass, plastics, wood, furniture, formica and more

Item #	Mfg. #	Description	Cs Pk	Cs Wt
521390	10	10 oz aerosol	12/10 oz	11.00 lb
521389	32	1 quart can	12/1 qt	32.00 lb
521388	128	1 gallon can	4/1 gal	38.00 lb

Sold in case pack only.

FRYER BOIL OUT

- Removes carbon build-up in fryer vats
- Contains sodium hydroxide for effective cleaning
- Economical and easy to use
- Measuring scoop in each case
- Each case contains 2-8 lb containers which is enough to do approximately 10 boil outs for a 50 lb fryer
- Will not leave foul odors or fumes

Item #431894

Mfg. #FB08

Cs Pk 2/8 lb

Cs Pk 16.00 lb

Sold in case pack only.



PROFESSIONAL EASY-OFF® OVEN & GRILL CLEANER

- Advanced grease-cutting formulas cut through burned-on grease and grime
- Ready to use - no offensive odor
- Great for use on ovens, grills, broilers and barbeques
- 24 oz aerosol

Item #257053

Mfg. #04250

Cs Pk 6/24 oz

Cs Wt 11.80 lb

Sold in case pack only.



BRITE SHINE™ CLEANER & POLISH

- Quickly cleans, restores and prolongs luster of metal surfaces
- Use on stainless steel, aluminum, brass and copper
- Resists finger marks and smudges
- Food grade quality

Item #398276

Mfg. #141211

Cs Pk 12/11 oz

Cs Wt 12.00 lb

Sold in case pack only.



MR. MUSCLE® HEAVY DUTY CLEANERS

- Oven and grill cleaner's self-scouring foam goes to work immediately on warm or cold ovens
- Penetrates carbonized soils and baked-on grease
- Fryer boil-out penetrates, emulsifies and cleans away built-up carbonized grease



#91209

#91206

Item #	Mfg. #	Description	Cs Pk	Cs Wt
369162	91209	Fryer Boil-Out (Pouch)	36/2 oz	5.99 lb
369274	91206	Oven Cleaner (Aerosol)	6/19 oz	7.83 lb

Sold in case pack only.





PROFESSIONAL EASY-OFF® MAX™ OVEN CLEANER

- Cold-oven use, no harsh fumes and no lye – no CFCs
- Lemon scent
- 24 oz aerosol

Item #343537
Mfg. #74017
Cs Pk 6/24 oz
Cs Wt 11.80 lb
Sold in case pack only.



PROFESSIONAL LYSOL® DISINFECTANT SPRAY

- Kills 99.9% of germs on hard, nonporous surfaces within 30 seconds
- Formula is tuberculocidal, virucidal, fungicidal and bactericidal
- Prevents odors and growth of damaging mold and mildew
- Original scent, 19 oz aerosol

Item #349458
Mfg. #04650
Cs Pk 12/19 oz
Cs Wt 19.11 lb
Sold in case pack only.



PROFESSIONAL LYSOL® DISINFECTANT FOAM CLEANER

- Kills Staph, Salmonella, Pseudomonas, HIV-1 (AIDS virus) and other harmful germs on hard, nonporous surfaces
- Rich foam clings to surfaces
- Cleans, shines, disinfects and deodorizes
- Prevents growth of damaging mold and mildew
- 24 oz foaming aerosol

Item #349453
Mfg. #02775
Cs Pk 12/24 oz
Cs Wt 23.40 lb
Sold in case pack only.



SPIC AND SPAN® 3-IN-1 DISINFECTING ALL-PURPOSE SPRAY AND GLASS CLEANER

- Powerful 3-in-1 formula disinfects, cuts grease and cleans glass
- Helps save time by cleaning surfaces only once – why clean when you can clean and disinfect
- Hospital grade disinfectant
- 32 oz spray bottle

Item #373400
Mfg. #31240
Cs Pk 8/32 oz
Cs Wt 19.26 lb
Sold in case pack only.



ANTIBACTERIAL KITCHEN CLEANER

- For general use in kitchens
- Cleans, disinfects and kills odor-causing germs
- Citrus scent
- 32 oz trigger spray bottle, ready-to-use

Item #349449
Mfg. #74411
Cs Pk 12/32 oz
Cs Wt 30.33 lb
Sold in case pack only.



COMET® CREME DISINFECTANT CLEANSER

- Abrasive cleanser with chlorine bleach clings to clean vertical and hard-to-reach surfaces, like toilet bowls, wall tiles, chrome, stovetops and ranges
- Safe for most hard surfaces
- 32 oz squeeze bottle

Item #325020
Mfg. #02280
Cs Pk 9/32 oz
Cs Wt 20.48 lb
Sold in case pack only.



COMET® CLEANER WITH BLEACH

- Excellent for cleaning tough greasy build up and helps remove troublesome food stains in the kitchen
- Tackles the greasy dirt that builds up throughout a restaurant
- Bleaches mold and mildew stains
- 32 oz spray bottle

Item #342832
Mfg. #02287
Cs Pk 8/32 oz
Cs Wt 19.26 lb
Sold in case pack only.



WINDEX® GLASS CLEANER

- Effective on hard, non-porous surfaces
- Exclusive glass cleaning formula - Ammonia-D®
- Starts cleaning before you wipe
- No streaking or filming – leaves glass and other surfaces sparkling
- Loosens soil on contact

32 oz Spray Bottle
Item #369286
Mfg. #90139
Cs Pk 12/32 oz
Cs Wt 28.37 lb
Sold in case pack only.
1 gallon
Item #369279
Mfg. #90940
Cs Pk 4/1 gal
Cs Wt 35.92 lb
Sold in case pack only.



#90139



DISPOSABLE/CHEMICAL

PLEDGE® FURNITURE POLISH

- Lemon scent, aerosol
- Unique blend of rich natural waxes
- Cleans and brightens dull furniture without waxy build-up
- Anti-Dust™ formula repels dust
- Leaves surfaces dust free longer

Item #369403

Mfg. #94430

Cs Pk 6/18 oz

Cs Wt 17.51 lb

Sold in case pack only.



JOY® MANUAL POT & PAN DETERGENT

- Powerful formula cuts through grease quickly and easily
- Long-lasting suds can help to reduce sink changeover
- Concentrated, lemon scent
- 38 oz squeeze bottle

Item #435715

Mfg. #45114

Cs Pk 8/38 oz

Cs Wt 23.92 lb

Sold in case pack only.



Procter&Gamble Professional™

PROFESSIONAL LYSOL® TOILET BOWL CLEANER

- Kills Staph, Pseudomonas, E. Coli, HIV-1 (AIDS virus) and other harmful germs on hard, nonporous surfaces
- Thick formula cleans, disinfects and deodorizes
- Dissolves tough rust stains and mineral deposits, but will not harm plumbing or septic systems
- Wintergreen scent in a no-waste, 32 oz angle-neck bottle

Item #349465

Mfg. #74278

Cs Pk 12/32 oz

Cs Wt 30.10 lb

Sold in case pack only.



DAWN® MANUAL POT & PAN DETERGENT

- Activates on contact to quickly and easily clean the toughest grease
- So powerful that 1 gallon can make over 640 gallons of dishwashing solution

Procter&Gamble Professional™



#45112

#02613

Item #	Mfg. #	Description	Cs Pk	Cs Wt
435714	45112	Regular Scent, 38 oz	8/38 oz	23.92 lb
325052	02613	Regular Scent, 1 gal	3/1 gal	29.50 lb

Sold in case pack only.

DISPOSABLE/CHEMICAL



SPIC AND SPAN® FLOOR CLEANER WITH BLEACH

- Helps fight tough stains with the power of chlorine bleach
- Cuts through tough, greasy soil
- Portion pack, 2.2 oz

Item #339479

Mfg. #02010

Cs Pk 45/2.2 oz

Cs Wt 6.80 lb

Sold in case pack only.

Procter&Gamble Professional™

SKIDOO® INSECTICIDE

- Specially formulated for institutional, commercial and industrial flying insect control
- NSF rated for use in food handling establishments

Item #474061

Mfg. #4203286

Cs Pk 6/16 oz

Cs Wt 10.00 lb

Sold in case pack only.



TIDE® INSTITUTIONAL FORMULA FLOOR & ALL PURPOSE CLEANER

- For cleaning floors and so much more!
- Powerful cleaning of both greasy soils and dirt to make cleaning quick and easy
- Easy rinse powder formula is ideal for quarry tile
- Zero phosphate, 36 lb

Item #325159

Mfg. #02364

Cs Pk 1/36 lb

Cs Wt 38.00 lb

Sold in case pack only.



Procter&Gamble Professional™

Item #	Mfg. #	Page #
3M		
367766	46	283
367786	63	280
367769	74	280
367759	82	283
378913	83	282
367789	84	282
367753	86	280
390020	87	282
367752	88	280
367750	96	280
373169	98	280
378964	410	283
464559	411	283
369645	461	283
378962	701	283
391135	702	283
378916	710	283
386110	720	280
367764	2000	280
461320	2020	280
367782	3000	280
369637	4500	288
378920	6000	288
369632	8541	295
367784	9030	280
369626	9489	280
367758	9650	280
396909	2000BP	280
367776	200CC	283
378912	200N	283
461970	2020CC	280
441709	4004CC	281
393216	405R	283
378911	46N	283
397035	700-40	283
378910	74N	280
378909	86N	280
401798	88N	280
434235	9488R	280
482277	9537CC	282
428099	9650N	280
378908	96N	280
402194	96NCC	280
378915	A21	281
414170	FSPT-2	192
378914	GB12	282

AJM PACKAGING

459092	GB02NP5C	307
459093	GB04NP5C	307
459095	GB06NP5C	307
459096	GB08NP5C	307
459097	GB10NP5C	307
459098	GB12NP5C	307
459099	GB16NP5C	307
459091	GS57NP5C	307
459090	HS70NP3C	307
460610	LP35NP5C	307
460613	LQ35NP5C	307
458283	PP6AJKWH	305
458280	PP6GREWH	305
458281	PP9BUKWH	305
458279	PP9GRAWH	305
458277	PP9GREWH	305
459108	SQ40NP5C	307
459109	SQ40NP5C25	307
462402	WB02NP5C	307
459114	WB04NP5C	307
459117	WB06NP5C	307
459122	WB08NP5C	307
459123	WB10NP5C	307
459124	WB12NP5C	307
459125	WB16NP5C	307

Item #	Mfg. #	Page #
ALLIED METAL SPINNING		
482679	APC2	261
482684	BST10	256
482687	CBC3	249
482688	CCPSET10X2	251
482689	CCPSET10X3	251
482691	CCPSET8X2	251
482695	CG1	261
482698	CL2	256
482699	CP10X2	251
482700	CP12X2	251
482704	CP14X2	251
482706	CP6X2	251
482707	CP8X2	251
484789	CP9X2	251
482708	CPH10X3	251
482711	CPT10X1	257
482713	CPT12X1	257
482715	CPT12X2	257
482716	CPT14X1	257
482717	CPT14X2	257
482719	CPT16X1	257
482722	CPT7X1	257
482723	CPT8X1	257
482724	CPT9X1	257
482729	CRS3238	250
482733	DC8	258
482734	DDFPP1	260
482736	DDHPP1	260
482737	DDHPP2	260
482769	DNC3	249
482738	DP800	258
482742	FP209	252
482744	FP210	252
482745	FP211	252
482746	FP212	252
482748	FS9211	249
482749	FSS16	249
482750	IRP5	249
484776	KBL9	249
482752	MDC6SET	261
482753	MG100	216
482754	MP12	251
482755	MP24	251
482757	MWOK16	256
523240	P1225	258
523226	P1235	258
523227	P1252	258
523229	P1438	258
523228	P1618S	258
482763	PB10	249
482764	PBE3020	250
482765	PBE3030	250
482766	PBE3040	250
482767	PBE3060	250
482768	PBE3110	250
482772	PD10	257
482774	PD12	257
482776	PD14	257
482778	PD16	257
482779	PD17	257
482808	PD18	257
482809	PKO16	260
482810	PKR20	260
484774	PMT8	115
482811	POP1	259
482812	POP43	259
482813	PP100	217
482815	PS20	258
482816	PS24	258
482817	PS28	258
482818	PS6	258
482820	PS7	258
482821	PSR10	259
482822	PTR11	259
484786	PTSL893	250

Item #	Mfg. #	Page #
484787	PTSL903	250
499912	RTS694	259
482826	SD10	243
482827	SF1025	251
482828	SF875	251
482829	SF95	251
482830	SPF4262	235
482830	SPF4262	252
482832	SPH2295	235
482832	SPH2295	252
482834	SRD6	219
482835	SRD8	219
482837	SRP12X15	257
482839	SRP14X15	257
482847	SRP16X15	257
482849	T10	257
482850	T11	257
482851	T12	257
482852	T13	257
482853	T14	257
482854	T15	257
482855	T16	257
482856	T17	257
482857	T18	257
482858	T19	257
482859	T20	257
482861	T7	257
482862	T8	257
482863	T9	257
482864	TBC-10	234
482865	TBC-8	234
482866	TCP750	250
482867	TCP9	250
482868	TCP925	250
482869	TCP95R	250
484785	WG1624	250
485204	WK2000	256
485201	WK850	256
523237	WP1222	258
523230	WP1236	258
523231	WP1242	258
523232	WP1436	258
523233	WP1442	258
523234	WP1642	258
515653	WP1832	258
523235	WP1842	258
523236	WP2042	258
523238	WP236	258
523239	WP336	258
482884	WR1S	256
482886	WS14	256
482887	WS20	256

ANCHOR HOCKING

489881	03212	35
489884	07767	35
425571	68347	38
378990	68349	38
382816	73010	38
379146	73017	38
378993	77174	38
378994	77420	38
383500	77422	38
378999	77722	32
379000	77746	32
379001	77770	37
379188	77787	37
379002	77794	37
386405	77796	37
379005	80009	38
379007	80011	38
379008	80012	38
379009	80013	34
379011	80016	38
379012	80018	33
379013	80019	34

MANUFACTURER NUMERICAL INDEX

Item #	Mfg. #	Page #
379015	80021	33
394226	80142	40
426104	80436	37
458686	90004	32
458840	90005	32
458841	90006	32
458843	90007	32
458847	90008	32
458850	90009	32
458864	90010	32
482542	90038	36
489846	90044	39
518392	90071	34
480552	93010	36
480553	93011	36
480554	93012	36
480555	93013	36
387675	133450	36
448203	165270	37
506969	100-00-01	35
531438	100-00-02	35
506970	100-00-07	35
523406	100-00-09	35
523405	100-00-12	35
523408	100-00-15	35
516752	100-00-16	35
518198	100-00-35	35
506971	100-00-37	35
379026	1150U	35
379027	1152U	35
379028	1153U	36
379030	1155UR	41
379033	1170U	36
379034	1172U	36
379035	121UR	41, 154
379037	139UR	41, 154
379038	143U	41
379040	148U	41
379043	16U	41, 135
379045	176FU	38
379046	1830EU	41, 135
379047	18U	35
379050	2047U	39
379051	2051U	39
379052	2081M	34
379053	2085M	34
379054	2095UX	34
379055	2238U	39
389980	2283Q	36
379058	279U	40
530774	283-00-11	35
427944	2907M	33
379062	2908M	33
379063	2910M	33
379064	2912UX	34
379065	2915M	33
379066	2917UX	34
379067	2926M	32
379068	2928M	32
379069	2930M	32
379070	2931M	33
379071	2932M	33
379073	2936M	32
427500	2938M	32
379076	2942M	33
383413	308U	40
379082	3108U	39
379086	3113U	39
379089	3141U	39
379090	3143U	39
379093	3167U	39
379094	3168U	39
379095	3169U	39
379096	3170U	39
379097	3172U	39
379098	3175U	39
379100	3178FU	39

Item #	Mfg. #	Page #
379101	3181EU	39
531256	350-00-10	40
523399	350-00-46	40
379106	3532/6721U	40
379107	3532U	40
388133	3666EU	36
386087	3667EU	36
379111	3668U	36
379114	3933M	33
446503	3950M	33
379116	3951M	33
386901	5054U	39
379120	524UX	34
389447	5280/1612U	36
379121	5281/931U	36
379122	5281/932U	36
379123	5281U	36
379124	5282/928U	36
379126	5282U	36
379127	562U	41
379128	563FU	41
379129	56EU	41
379130	575GU	41
379132	6099U	41, 135
385609	69349T	40
382870	69372T	40
400256	69590R	40
379135	7176FU	38
379141	7221M	33
379143	72U	41
379153	7409U	37
379154	7410U	37
379155	7412U	37
395499	7511U	40
379159	7513U	40
379160	7514U	40
379174	7729U	32
379176	7730U	32
379179	7732U	32
379180	7733U	32
379183	7745U	32
379191	77788R	37
379192	77790R	37
379193	77792R	37
379195	799U	32
390644	80226X	34
387645	80278X	34
379200	828U	41
379201	842U	41
527923	90054A	37
425325	980R	41
396619	H023202	37
396628	H037491	34
414012	H054504	38
414010	H054539	38
417017	H054540	38

APW WYOTT

423114	56638	167
423106	AT-EXPRESS	168
423127	CCW	170
423099	CDO-17	176
423111	CW-2A	167
423126*	DR-2A	170
423125	DS-1A	170
526659	GCB-24H	173
526656	GCB-36H	173
428872	GCRB-24H	173
531728	GCRB-36H	173
509889	GGM-24H	173
531730	GGM-36H	173
531729	GGT-24H	173
438808	GGT-36H	173
523636	GHP-2H	173
531732	GHP-4H	173
423122*	HRS-31	170
423130	MPC-1A	170

Item #	Mfg. #	Page #
423119	PD-1A	165
423109	RCW-11	166
423108	RCW-7	166
423123*	SG-31	170
423110	W-3V	167
423112	W-43V	167

ARDEN BENHAR

436551	CH201280-10P	269
423355	CL2PBIAWH	267
423346	CL2PX25BETF	264
423347	CL2PX27BETF	264
423356	CL3PBIABGFP	267
423357	CL3PBIABKFP	267
423359	CL3PBIAHGFP	267
423360	CL3PBIANVFP	267
423361	CL3PBIARDFP	267
423367	CL3PWACBK	267
423354	CLBIAWH	267
428350	CLBMR	268
430133	CLCH3	268
430135	CLCH3D	268
430139	CLCOAT1X	266
430140	CLCOAT2X	266
430138	CLCOATLG	266
430137	CLCOATMM	266
430136	CLCOATSM	266
430134	CLHTBBC	268
458975	CLOMS26SL	264
423366	CLOVA	267
423350	CLPG1	263
430151	CLSHIRT1X	266
430150	CLSHIRTLG	266
430149	CLSHIRTM	266
430147	CLSHIRTS	266
423351	CLTPH8BK	263
423365	CLVA	267
432007	RPTW	249

BAR MAID

503915	A-200	155
538112	BMP-3100B	151
538115	BMP-3125G	151
538116	BMP-3125R	151
538117	BMP-5100B	151
538118	BMP-5125G	151
538120	BMP-5150R	151
503910	BRS-1720SL	155
503911	BRS-1722	155
508409	BRS-917	155
531739	CR-1240	151
531681	CR-1270	150
531740	CR-1600	151
538119	CR-1620AC	151
531685	CR-701	155
531741	CR-7400AC	151
531742	CR-753BLK	148
503902	DET-200	155
503905	DIS-201	155
503904	DIS-202	155
503903	DIS-302	155
503913	GWM-200	155
503912	GWM-300	155
503914	SS-100	155

BLAZE PRODUCTS

181673	BB100	112, 302
520604	BB400	112, 302
398476	CW300	112, 302
181666	GB100	112, 302
181698	GB200	112, 302
181709	LB300	112, 302
533487	LB700	112, 302
345744	SB700	112, 302

MANUFACTURER NUMERICAL INDEX

Item #	Mfg. #	Page #
BLOOMFIELD		
379737	7759	131
471810	7760	131
493435	8852	128
371137	8885	129
379733	8895	129
379721	8903	129
379731	8913	129
387556	NMLX102	306
387557	NMLX103	306
387562	NMPF102	306
387563	NMPF103	306

Item #	Mfg. #	Page #
BUNN		
497074	06310.0004	128
497068	12950.0212	127
497066	12950.0213	127
501860	13300.0002	127
497697	13300.0003	127
498609	20583.0003	128
497075	32125.0000	131
497078	32130.0000	131
516978	33000.0001	128
497070	33200.0000	128
497696	34100.0000	128
497126	39000.0002	128
497144	39637.0001	128
514011	04238.0000	128
497112	06078.0003	129
497122	06078.0024	129
497123	06088.0003	129
497125	06088.0012	129
497099	06100.0103	129
497110	06101.0103	129
288807	20100.0000	305
289574	20106.0000	305
343748	20122.0000	305
289617	20125.0000	305

Item #	Mfg. #	Page #
CACTUS MAT		
476178	1437M-B35	284
480101	2200-35	284
476174	2520-C1	284
476175	2520-C3	284
476176	2520-R1S	284
476177	2520-R3S	284
476169	2530-C5	284
476170	2530-R5	284
476179	2535-B34	284
507513	3520-R1	284
476171	3525-C1	284
476173	3525-R1	284
476180	5000-R35	284
476181	6477-KD	284

Item #	Mfg. #	Page #
CAMBRO		
379663	100BC1-131	145
380055	100BC1-157	145
380616	100BC1-158	145
379665	100MCCW-135	243
369818	1014FF-163	143
368286	1014FF-167	143
379746	10CWC-135	240
379763	10CWCH-135	240
379770	10CWCHN-135	240
431260	10CWD-135	240
389255	10HC258-151	270
379777	10HPCH-150	240
423334	10PPCH-190	241
431290	10PPSC-190	241
431261	10SC-148	240
368130	1200P-152	60
368124	1200P-153	60
368192	1200P2-152	60
369889	1200P2-153	60
386395	1200P2-156	60

Item #	Mfg. #	Page #
370372	1216FF-163	143
369960	1216FF-167	143
467365	1216FF-416	143
379787	12183CW-135	194
379805	12186CW-135	194
379818	12186P-148	194
379821	12189CW-135	194
379825	12189P-148	194
379829	1218CCW-135	194
379842	1218CP-148	194
431257	12CW-110	240
379847	12CW-135	240
379855	12HP-150	240
379863	12SFSCW-135	195
379871	12SFSP-148	195
379874	1400CT-110	143
379884	1400CT-138	143
369884	1418FF-163	143
367793	1418FF-167	143
431258	14CW-110	240
379889	14CW-135	240
379900	14HP-150	240
423322	14PP-190	241
458925	1596CW-186	144
379907	1600CT-110	143
380057	1600CT-138	143
367940	1600P-152	60
368013	1600P-153	60
380060	1600P2-152	60
368328	1600P2-153	60
370016	1600P2-156	60
389256	16C258-151	270
431259	16CW-110	240
380067	16CW-135	240
423323	16PP-190	241
458178	16S418-151	270
432222	16S534-151	270
458174	16S738-151	270
458145	16S800-151	270
380068	182615CW-135	194
380074	182615P-148	194
380076	18263CW-135	194
380078	18263P-148	194
380083	18266CW-135	194
380087	18266P-148	194
380090	18269CW-135	194
380097	18269P-148	194
380099	1826CCW-135	194
487289	1826CLRCW	194
380103	1826CP-148	194
380105	18SFSCW-135	195
380107	18SFSP-148	195
367950	2000P-152	60
369886	2000P-153	60
376213	2000P-156	60
373978	2000P2-152	60
369847	2000P2-153	60
384521	2000P2-156	60
380112	200BC1-131	145
380115	200BC1-158	145
380117	200MCCW-135	243
432143	20CFC-135	118
380120	20CWC-135	240
380123	20CWCH-135	240
380125	20CWCHN-135	240
431267	20CWD-135	240
382390	20CWLN-135	241
380129	20HPCH-150	240
382393	20HPLN-150	241
423335	20PPCH-190	241
431291	20PPSC-190	241
431266	20SC-148	240
431262	22CW-110	240
380133	22CW-135	240
380135	22HP-150	240
380136	22SFSCW-135	195
380137	22SFSP-148	195

Item #	Mfg. #	Page #
459598	23CLRCW-135	239
401468	23SLB250	194
431263	24CW-110	240
380138	24CW-135	240
380139	24HP-150	240
484632	24LPCW-110	240
423325	24PP-190	241
398914	250LCD-110	122
369836	250LCD-131	122
459601	25CLRCW-135	239
380140	25MCCW-135	243
458674	25S418-151	270
458151	25S534-151	270
432227	25S738-151	270
458967	26CF-110	118
431296	26CF-148	118
431265	26CW-110	240
380141	26CW-135	240
423326	26PP-190	241
398323	2700CT-110	143
380324	2700CT-138	143
380331	2SFSCW-135	195
380335	2SFSP-148	195
472120	2SFSPPSW3190	195
431125	300MPC-110	122
369885	300MPC-131	122
432146	30CFC-135	118
380339	30CWC-135	240
380342	30CWCH-135	240
431274	30CWCHN-135	240
431272	30CWD-135	240
382391	30CWLN-135	241
380357	30HPCH-150	240
382402	30HPLN-150	241
423337	30PPCH-190	241
393083	30SC-148	240
371389	3200P2-152	60
368024	3200P2-153	60
390412	3200P2-156	60
380368	32CW-135	240
431269	34CW-110	240
380373	34CW-135	240
380375	34HP-150	240
423327	34PP-190	241
442083	350LCD-131	122
459603	35CLRCW-135	239
431350	36CF-148	118
431270	36CW-110	240
380377	36CW-135	240
380381	36HP-150	240
423329	36PP-190	241
458152	36S418-151	270
458147	36S534-151	270
368231	400MCCW-135	243
380384	40CWCH-135	240
399056	40CWD-135	240
431293	40PPSC-190	241
380395	42CW-135	240
380398	44CW-135	240
380400	44HP-150	240
380404	46CW-135	240
380408	46HP-150	240
380422	4SFSCW-135	195
380425	4SFSP-148	195
472121	4SFSPPSW3190	195
460012	500LCD-110	122
380429	500LCD-131	122
367810	500P-152	60
368213	500P-153	60
388024	500P-156	60
368333	500P2-152	60
375778	500P2-153	60
398319	500P2-156	60
380577	50MCCW-135	243
516013	5FBRTT-110	123
380580	60CCW-135	240
432025	60CFC-135	118

MANUFACTURER NUMERICAL INDEX

Item #	Mfg. #	Page #	Item #	Mfg. #	Page #	Item #	Mfg. #	Page #
531459	01133	51	531624	47902	78	531507	C3966	50
531460	01141	51	531626	47913	78	531510	D0795	45
531461	01158	51	531627	47925	78	531513	D0796	44
531462	01166	51	531628	47929	78	531514	D2024	43
531463	01224	51	531630	47982	78	531515	D6140	45
531464	01273	51	531633	48024	44	531517	D9016	51
531465	04757	43	531635	48025	78	531518	D9070	51
531468	07131	50	531637	48087	78	531519	E1515	49
531470	07134	50	531639	48112	78	531520	E1516	49
531472	08781	51	531640	48201	78	531521	E1907	48
531475	09232	43	531641	48225	78	531522	E2788	45
531476	09994	51	531642	48722	47	531523	E2789	45
531478	10007	46	531643	48728	51	531525	E2790	45
531480	10027	51	531645	49357	49	531527	E5358	44
531482	10887	78	531646	49698	51	531528	E8516	46
531484	12558	78	531647	50061	80	531535	E8518	46
531699	12652	47	531649	50816	44	531536	E8519	46
531689	12926	44	531708	51254	50	531537	E8520	46
531486	14611	80	531650	51752	42	531538	E8792	49
531701	14798	44	531651	53224	49	531539	E8883	51
531702	15442	43	531652	53664	46	531541	E9155	51
531488	17197	46	531653	55219	78	531543	E9156	51
531502	17198	46	531710	55878	50	531545	E9157	51
531504	19343	50	531654	57069	46	531547	E9158	51
531506	20750	47	531655	57070	46	531551	E9159	51
531508	20864	44	531469	57282	46	531553	E9160	51
531509	20865	44	531471	57286	46	531555	E9336	45
531511	20866	44	531473	57974	80	531557	G0320	80
531512	20867	44	531477	57975	80	531558	G2100	51
531524	20868	44	531479	58001	45	531560	G2102	51
531526	20869	44	531481	58621	80	531562	G2277	79
531529	20871	44	531483	59943	80	531566	G3570	45
531530	20873	43	531711	62447	45	531568	G3573	45
531531	20874	43	531485	62449	45	531571	G3745	79
531532	20875	43	531489	62899	50	531573	G3751	79
531533	22506	80	531487	64733	80	531576	G3752	79
531540	22514	80	531693	71075	42	531578	G3754	79
531542	22522	80	531490	71076	43	531580	G4315	51
531544	22530	80	531491	71078	43	531582	G4373	79
531546	22662	80	531492	71079	43	531586	G4375	79
531548	22670	80	531698	71080	42	531588	G4392	79
531549	22712	80	531493	71081	43	531590	G4394	79
531550	22760	43	531494	71082	42	531591	G4395	79
531552	23876	43	531495	71083	42	531592	G4396	79
531554	24742	80	531496	71084	42	531593	G4398	79
531556	25251	80	531497	71086	42	531595	G4399	79
531559	25263	50	531498	71092	43	531597	G4765	79
531561	25269	80	531499	71093	43	531598	G4975	79
531563	25275	50	531500	79320	43	531458	O1005	47
531564	25285	80	531501	79698	48	531466	O5273	78
531565	25293	80	531503	79728	48	531467	O5425	47
531567	28891	80	531505	79747	48	531600	R0734	78
531569	29811	48	531657	101223	42	531601	R0735	78
531570	29879	47	531658	101226	42	531603	R0736	78
531572	36140	80	531669	101231	48	531605	R0737	78
531574	40326	47	531659	102086	42	531606	R0738	78
531575	40334	47	531680	165629	50	531608	R0739	78
531577	40383	47	531670	218416	48	531610	R0740	78
531704	43279	47	531660	332103	42	531612	R0741	78
531579	43280	47	531671	364624	48	531614	R0742	78
531581	43281	47	531661	366087	42	531616	R0743	78
531583	43282	47	531668	432100	42	531618	R0744	78
531587	43319	80	531682	442116	50	531620	R0745	78
531589	43716	49	531667	455078	42	531622	R0746	78
531599	44032	47	531672	481322	48	531623	R0747	78
531705	46697	46	531673	490249	48	531625	T3601	104
531602	46774	46	531679	521284	50	531631	T3602	104
531604	46888	44	531674	660962	48	531632	T3604	104
531607	46961	44	531675	664625	48	531634	T3606	104
531609	46973	44	531676	703225	48	531636	T3628	104
531611	46978	44	531665	887209	42	531638	T3629	104
531707	46981	45	531677	896402	48			
531613	47017	45	531666	899289	42			
531615	47019	45	531683	1012316	49			
531617	47026	45	531684	1012317	49			
531619	47346	44	531686	1012318	49			
531621	47900	78	531688	1012319	49			

CARLISLE

380830	40681	223
397501	020230	118
380662	029503	120
380663	029506	120

MANUFACTURER NUMERICAL INDEX

Item #	Mfg. #	Page #
379972	105	298
400785	119	292
379925	516	294
538289	596	289
538293	601	289
538288	608	289
368515	712	292
390237	716	292
538290	772	289
399889	2400	295
483688	3255	285
394834	5325	288
399881	5327	288
483668	1001GY	285
483672	1001WH	285
483680	1002GY	285
483681	1002WH	285
483701	1358BE	286
483702	1358BK	286
373929	1425BN	285
483696	1702BE	286
483673	2000GY	285
483674	2000WH	285
483682	2001GY	285
483683	2001WH	285
528279	222YW	292
385596	226-3YW	291
379992	250K	297
400371	250W-6	297
483695	25BE	286
483699	2818BE	286
483700	2818BK	286
484998	3200-1	285
483675	3200GY	285
483676	3200WH	285
483684	3201GY	285
483685	3201WH	285
413555	335-37YW	291
390552	335-3YW	291
384445	351YW	291
437900	404-3YW	291
483697	4114BE	286
483698	4114BK	286
483677	4444GY	285
483678	4444WH	285
483686	4445GY	285
483687	4445WH	285
369931	523BK	285
483679	5500GY	285
484335	5501GY	285
484333	5550GY	285
368422	5805BE	277
369941	5810BK	278
377376	5811BK	278
377377	5812BK	278
483703	8110GY	295
483704	8114GY	295
484331	8216GY	295
455160	8252-H	301
483693	8321BE	286
483694	8321GY	286
457696	887BE	285
372851	888BK	285
445567	912BK	292
459532	991C	299
431775	A02802.D02	289
431796	A03312.D02	289
431776	A0401124.D03	289
431777	A0401132.D03	289
431451	A04902.D02	289
380002	A05011	289
380004	A05012	289
380006	A05013	289
431768	A05103.D02	289
431790	A414124.D03	289
399650	A427124	289

Item #	Mfg. #	Page #
431797	A605024	289
521218	A70902	289
431449	A71302	290
379998	A902116	289
379999	A903120	289
431779	A903120.D03	289
431783	A903320.D03	290
380000	A904128	289
431781	A904128.D03	289
431795	A913320.D03	290
423878	E502036	293
431801	E503500	293
431804	E503600	293
431799	E504028	293
398332	E507008	293
431802	E507012	293
431803	E515012	293
379782	F006124	294
379790	F007124	294
379793	F101124	294
399887	I001010	294
431805	I004000	294
379989	J507017	296
379800	M101060	294
379803	M105060	294
379808	M109060	294
393202	NI101MF	298
410690	SW7YW	291

CONTINENTAL GLIT/DISCO

408968	1182	298
500071	164-1	297
489818	165-2	297
398326	1800	295
487489	226-312YW	291
503766	7325GY	286
503818	8322BN	286
498959	8322GY	286
499084	902-3RW	300
445567	912BK	292
380075	A414124	289
443837	A901112	289
488476	A904324	290
432050	D104	281
431942	D104/12	281
431898	D1217S3	307
431903	D1324S5	307
431900	D1422E3	307
431901	D1618S4	307
431899	D1624S4	307
431904	D1625S3	307
443868	D1722E4	307
502609	D1724S4	307
436573	D1728S5	307
436575	D1820E5	307
432045	D204	281
431941	D204/12	281
431910	D2178D4	307
432213	D32000T	280
432212	D33000TPO	280
431800	E502024	293
431894	FB08	308
385446	FC-10-3	307
436193	FCH-10-1	307
431912	FW12	194
431913	FW65	194
508281	G35	282
436608	GB12DISCO	282
431951	GCSHR	282
431920	GP46	282
431952	GP46/20	282
488353	GPH10HR	282
432726	GPH10HR/2	282
431940	GS10/20	282
431919	HD69	281
431956	HD69/15	281

Item #	Mfg. #	Page #
432051	MD69	281
431946	MD69/20	281
431943	MD9650/60	281
431929	PP80	281
431957	PP80/20	281
431928	PP88	281
480369	SP1210	281
431958	SP1210BRILLO	281
431917	SS652	281
488902	SW12YW	291
431895	WP69/20	281

COOPER/ATKINS CORP.

444704	1236-70-1	185
437204	1246-01-1	185
437208	1246-02-1	185
437209	1246-03-1	185
442979	1246-05-1	185
437210	24HP-01-1	186
437211	25HP-01-1	186
459686	26HP-01-1	186
479005	3210-08-1E	186
437214	322-01-1	186
437213	323-01-1	186
438376	3270-05-5	186
437215	330-0-1	187
437212	335-01-1	187
489271	462-0-8	187
437217	470-0-8	187
437218	480-0-8	187
494506	535-0-8	186
438377	9150-0-8	186
437224	93230-K	185
437289	DFF450W-0-8	186
437225	DPP400W-0-8	185
437226	DT300-0-8	185
437221	FT24-0-3	188
437223	TC6-0-8	188
445582	TFS4-0-8	188
437219	TM60-0-8	188

DAYMARK

481951	110084	192
482014	110105	192
481952	110116	192
453573	110418	193
458044	110422	193
453636	110428	193
453631	110493	193
453607	110501	193
453635	110767	193
453616	110806	193
453638	111181	192
453637	111183	192
459732	113419	193
481566	113720	193
482625	113786	193
482000	1100371	192
482001	1100372	192
482002	1100373	192
482003	1100374	192
482004	1100375	192
482032	1100376	192
482006	1100377	192
481993	1100591	192
481994	1100592	192
481995	1100593	192
481996	1100594	192
481997	1100595	192
481998	1100596	192
481999	1100597	192
482007	1100601	192
482008	1100602	192
482009	1100603	192
482010	1100604	192
482011	1100605	192

MANUFACTURER NUMERICAL INDEX

Item #	Mfg. #	Page #
482012	1100606	192
482013	1100607	192
481981	1103411	192
481983	1103412	192
481986	1103413	192
481988	1103414	192
481989	1103415	192
481991	1103416	192
481992	1103417	192
453578	1104091	193
453579	1104092	193
453580	1104093	193
453583	1104094	193
453584	1104095	193
453585	1104096	193
453586	1104097	193
457993	1122131	192
457996	1122132	192
457997	1122133	192
458000	1122134	192
458002	1122135	192
458005	1122136	192
458007	1122137	192

DEXTER RUSSELL

393331	1515	207
437897	85869	207
394293	12SXL	203
393314	28912MF-PCP	207
394305	3-Way	203
393302	40D-12PCP	205
393303	45-10PCP	205
397937	85849PCP	207
393372	85859PCP	207
394291	A12R	203
393403	CC1	204
393329	DDS-12	203
393371	L4504	207
393332	LS8698	207
437361	P17	206
437368	P177A-4PCP	206
447008	P177A-PCP	261
393364	P3A-PCP	261, 206
393357	P40003	208
393359	P40843	208
437634	P94005	208
397864	P94801	208
393352	P94802	208
393351	P94803	208
393365	P94804	208
393366	P94805	208
397869	P94807	208
397872	P94816	208
393349	P94823	208
393353	P94831	208
393356	P94843	208
397880	P94846	208
393354	P94850	208
397913	P94851	208
393360	P94852	208
393361	P94853	208
397914	P94854	208
393367	P94855	208
393369	P94856	208
447745	P94ZZA-4	208, 261
393319	PR180-20	206
393363	PS286-8	204
437886	PS286-8PCP	204
393370	PS8698PCP	207
397935	S104-3CARD	202
393402	S104PCP	202
437767	S104SC-PCP	202
393400	S107PCP	202
393385	S112-10PCP	203
393386	S118-14DH	203
394297	S121PCP	202

Item #	Mfg. #	Page #
393388	S127PCP	202
393374	S131-6PCP	203
393387	S132-10PCP	203
393393	S133-8PCP	203
393378	S136N-PCP	203
393375	S136PCP	203
394299	S137PCP	202
437636	S140-12PCP	203
393413	S140-12SC-PCP	203
393415	S142-9SC-PCP	202
393389	S145-10PCP	203
397921	S145-10SC-PCP	203
397924	S145-12PCP	203
393390	S145-8PCP	203
393383	S147-10SC-PCP	203
393407	S154HG-PCP	202
393337	S156SC-PCP	202
393416	S158SC-PCP	202
393397	S160-16	206, 260
393401	S160-18	206, 260
393405	S161	206, 260
393382	S162-8SC-PCP	203
429560	S163-7SC/9SC	203
393395	S163-9SC-PCP	203
397922	S170	208
423639	S170L-3	208
437899	S171PCP	204
437905	S172 1/2PCP	204
435463	S172PCP	204
393410	S173PCP	202
431475	S173SC-3-RYG	203
393411	S173SC-PCP	202
437683	S174PCP	204
437683	S174PCP	206, 260
437542	S175	204
393406	S176	206, 260
393348	S182-1/2PCP	204
458552	S185	203
393409	S186PCP	203
437813	S196PCP	204, 206, 249, 261
393315	S197PCP	206
393394	S205PCP	204
435457	S240PCP	207
393335	S242-1/2PCP	207
435458	S242PCP	207
435453	S244PCP	206, 207, 261
393317	S245R-PCP	207
393325	S24910B	206
397923	S2493 1/2PCP	207
393321	S2493-1/2SC	206
394301	S2496-1/2	206
435454	S2496PCP	206
393326	S2498	206
437849	S284-6 1/2PCP	204
437912	S285-3PCP	204
393350	S285-4PCP	204
396040	S286-4PCP	204
437891	S286-6	204
394302	S286-6PCP	204
435468	S286-6RC	204
437894	S286-8PCP	204
393313	S2896 1/2PCP	207
435462	S294PCP	204
393320	S3A	206
393320	S3A-PCP	261
393316	S42	206
393312	S496	206, 261
393308	S5198PCP	206
437898	S8694	207
393336	S8696PCP	207
393338	S8698PCP	207
393339	S8699PCP	207
425197	SG104B-PCP	205
397844	SG107PCP	205
437599	SG133-8PCP	205
423649	SG136B-PCP	205
423650	SG136FB-PCP	205

Item #	Mfg. #	Page #
437846	SG140-12GE-PCP	205
393340	SG140-12PCP	205
393342	SG140-12SC-PCP	205
432394	SG144-7B-PCP	205
423655	SG145-10B-PCP	205
393391	SG145-10PCP	205
393384	SG147-10SC-PCP	205
423657	SG156SCB-PCP	205
423632	SG158SCB-PCP	205
393396	SG162-8SC-PCP	205
423659	SG162-8SCB-PCP	205
394304	SG163-9SC-PCP	205
423633	SG163-9SCB-PCP	205
394303	SGCC7	204
423644	SS3	204
482592	V105PCP	202
449479	V136N-PCP	202
449487	V144-9GE-PCP	202
449484	V145-10PCP	202
482591	V156SC-PCP	202
481803	V158SC-PCP	202
449485	V162-8SC-PCP	202
449486	V163-9SC-PCP	202

DISCOVERY PRODUCTS

398273	10101	308
398274	10102	308
398269	10619	308
398272	10632	308
398270	10919	308
398276	141211	308
398271	11219DC	308
400886	40130-4	308

EDLUND

370006	203	246
370033	266	246
426531	11000	246
368686	11100	246
379156	12100	246
369994	39600	198
379453	4409HD	222
379455	4409HDL	222
379454	4412HD	222
379456	4412HDL	222
459648	4416HD	222
379452	50SS	247
379458	6416HD	222
379167	DR-2-OP	245
454589	E-160	244
486780	EDL-10RB	244
485825	G003M	246
485827	G004M	246
376991	G006SP	246
370315	G030SP	246
485828	K004M	246
485826	K005M	246
376992	K006SP	246
370308	K032SP	246
477056	KR-699	199
379184	S-11	246
379175	SR-2	245
378041	SR-25	245
379178	SR-5	245
379190	U-12	247

FOCUS FOODSERVICE LLC & FOCUS/REGALWARE

531744	FK183674CH	179
531746	FK183674GN	179
531743	FK184874CH	179
531745	FK184874GN	179
426454	58001R	127
426472	58055R	127
426473	58101R	127
426474	58155R	127

MANUFACTURER NUMERICAL INDEX

Item #	Mfg. #	Page #
426455.....	58230R.....	127
539079.....	908825PB.....	131
539081.....	908830PB.....	131
502146.....	FESW.....	217
397972.....	K1301A.....	127
397971.....	K1355A.....	127
423178.....	KPW9101.....	130
482557.....	KPW9111.....	130
482558.....	KPW9112.....	130
482559.....	KPW9113.....	130

G.E.T. ENTERPRISES

528071.....	00084-1-CL.....	61
528072.....	6609-1-6-CL.....	60
531357.....	6612-1-2-A.....	60
534411.....	6612-1-2-BL.....	60
528073.....	6612-1-2-CL.....	60
531371.....	6612-1-2-R.....	60
528074.....	6612-1-6-A.....	60
531378.....	6612-1-6-CL.....	60
531379.....	6612-1-6-R.....	60
531380.....	6616-1-2-A.....	60
531382.....	6616-1-2-BL.....	60
531383.....	6616-1-2-CL.....	60
531386.....	6616-1-2-R.....	60
528075.....	6616-1-6-A.....	60
528076.....	6616-1-6-CL.....	60
531390.....	6620-1-2-BL.....	60
531394.....	6620-1-2-CL.....	60
531397.....	6620-1-2-R.....	60
528078.....	6620-1-6-A.....	60
528079.....	6620-1-6-CL.....	60
528080.....	6620-1-6-R.....	60
531400.....	6624-1-2-R.....	60
528081.....	6624-1-6-R.....	60
531402.....	6632-1-2-CL.....	60
530444.....	6632-1-4-BL.....	60
528083.....	6632-1-4-CL.....	60
531403.....	6695-1-2-CL.....	60
534408.....	6695-1-6-A.....	60
534410.....	6695-1-6-BL.....	60
528085.....	6695-1-6-CL.....	60
531317.....	8812-1-CL.....	61
528086.....	8816-1-CL.....	61
531320.....	8820-1-CL.....	61
528871.....	9909-1-CL.....	60
528872.....	9912-1-CL.....	60
531259.....	9914-1-CL.....	60
528869.....	9916-1-CL.....	60
528870.....	9920-1-CL.....	60
528087.....	B-139-BK.....	91
528088.....	B-1611-BK.....	91
531316.....	B-788-BK.....	91
531318.....	B-788-W.....	91
531322.....	B-789-BK.....	91
531321.....	BC-007-T.....	92
531328.....	BC-007-W.....	92
529456.....	BW-1100-CL.....	63
528090.....	DD-50-CL.....	138
528092.....	DN-310-T.....	92
528093.....	DN-313-T.....	92
528094.....	DN-315-T.....	92
528096.....	DN-316-T.....	92
528097.....	DN-335-T.....	92
528098.....	DN-335-W.....	92
531332.....	DN-350-T.....	92
531346.....	DN-350-W.....	92
531353.....	DN-902-BA.....	91
534397.....	DP-505-T.....	92
534396.....	DP-505-W.....	92
534398.....	DP-506-T.....	92
528099.....	DP-506-W.....	92
528101.....	DP-507-T.....	92
528102.....	DP-507-W.....	92
528103.....	DP-509-T.....	92
534399.....	DP-509-W.....	92
528104.....	DP-510-T.....	92

Item #	Mfg. #	Page #
531348.....	DP-510-W.....	92
528105.....	ER-020-BR.....	91
528106.....	ER-020-CL.....	91
528107.....	ER-020-W.....	91
531301.....	ER-025-CL.....	91
531302.....	ER-040-CL.....	91
528108.....	ER-045-W.....	91
531305.....	ER-402-CL.....	91
528109.....	F-625-BR.....	91
529351.....	F-625-IV.....	91
531324.....	H-14-1-CL.....	61
528110.....	HC-100-N-1.....	145
531271.....	HI-2001-CL.....	91
531273.....	ML-10-W.....	92
531261.....	ML-113-W.....	91
531275.....	ML-122-W.....	92
531279.....	ML-60-W.....	92
531281.....	ML-61-BK.....	92
531285.....	ML-61-W.....	92
531287.....	ML-62-W.....	92
531289.....	ML-63-BK.....	92
531291.....	ML-63-W.....	92
531293.....	ML-77-W.....	92
531295.....	ML-82-W.....	92
531296.....	ML-84-BK.....	92
531298.....	ML-87-W.....	92
531300.....	ML-88-VN.....	92
531404.....	ML-94-VN.....	92
531266.....	NP-9-DI.....	91
531264.....	OB-938-R.....	140
534400.....	OP-610-T.....	92
534401.....	OP-610-W.....	92
528111.....	OP-612-T.....	92
528112.....	OP-612-W.....	92
528113.....	P-3064-1-CL.....	63
528114.....	RB-880-BK.....	140
528115.....	RB-892-BK.....	140
532955.....	RM-387-IV.....	90
531307.....	RM-387-W.....	90
531308.....	RM-388-BR.....	90
532956.....	RM-388-IV.....	90
528116.....	RM-388-MIX.....	90
531310.....	RM-400-BK.....	90
528117.....	RM-400-IV.....	90
531312.....	RM-401-BK.....	90
528118.....	RM-401-IV.....	90
531326.....	S-15-1-CL.....	61
531334.....	S-16-1-CL.....	61
531313.....	S-620-CB.....	90
528119.....	S-620-IV.....	90
528120.....	S-630-BK.....	90
528121.....	SC-66-BK.....	87
531314.....	SD-05-BK.....	91
528122.....	STRAPS.....	145
529935.....	SW-1401-1-CL.....	61
533140.....	SW-1402-1-CL.....	61
531337.....	SW-1404-1-CL.....	61
531339.....	SW-1406-1-CL.....	61
531340.....	SW-1408-1-CL.....	61
531343.....	SW-1409-1-CL.....	61
531345.....	SW-1419-1-CL.....	61
528874.....	SW-1423-1-CL.....	61
531347.....	SW-1426-1-CL.....	61
531309.....	SW-1427-1-CL.....	61
531315.....	SW-1431-1-CL.....	61
528123.....	TS-1200-BK.....	138
537135.....	TSW-103.....	144

GOLDMAX/POLY-KING

400534.....	10036.....	305
400532.....	1001-1.....	305
400533.....	1002-1.....	305
407173.....	1004-1.....	305
400535.....	1005-1.....	305
400555.....	1013-6.....	305
402998.....	1087-1.....	305
400544.....	2001-1.....	305

Item #	Mfg. #	Page #
425878.....	20431.....	262
400560.....	2100-4.....	297

HALL CHINA

475575.....	195-OAWHA.....	86
475577.....	362-OAWHA.....	90
475578.....	363-OAWHA.....	90
475584.....	371-OAWHA.....	90
476048.....	4530-OAWHA.....	90
476049.....	4531-OAWHA.....	90
476050.....	4532-OAWHA.....	90
476051.....	4533-OAWHA.....	90
476052.....	4534-OAWHA.....	88
476053.....	4535-OAWHA.....	88
476054.....	4536-OAWHA.....	88
476055.....	4537-OAWHA.....	88
476056.....	4538-OAWHA.....	88
476058.....	4539-OAWHA.....	86
476059.....	4541-OAWHA.....	87
476061.....	4542-OAWHA.....	88
476062.....	4544-OAWHA.....	88
476064.....	4551-OAWHA.....	88
475613.....	498-OAWHA.....	88
475617.....	527-OAWHA.....	88
475623.....	528-OAWHA.....	88
475574.....	82-OAWHA.....	85
476019.....	829-OAWHA.....	90
476021.....	834-1/2-OAWHA.....	90
476020.....	834-OAWHA.....	90
476022.....	835-OAWHA.....	90
476023.....	839-OAWHA.....	90
476034.....	844-OAWHA.....	90
476035.....	852-OAWHA.....	88
476036.....	853-OAWHA.....	88
476040.....	864-OAWHA.....	88

HAMILTON BEACH

381277.....	932.....	156
381281.....	990.....	161
477425.....	32182.....	166
485384.....	98908.....	158
477558.....	6126-HBB908.....	158
381295.....	78-06.....	227
381296.....	78-08.....	227
381297.....	78-10.....	227
381298.....	78-12.....	227
381299.....	78-16.....	227
381300.....	78-20.....	227
381301.....	78-24.....	227
381302.....	78-30.....	227
381303.....	78-40.....	227
429566.....	80-06.....	227
424398.....	80-08.....	227
424399.....	80-10.....	227
430219.....	80-12.....	227
424401.....	80-16.....	227
429567.....	80-20.....	227
429568.....	80-24.....	227
424402.....	80-30.....	227
424403.....	80-40.....	227
398201.....	CPM700.....	164
458207.....	HBB250.....	158
458212.....	HBB250S.....	158
458206.....	HBB908.....	158
485062.....	HBFB400.....	161
460645.....	HBH450.....	158
469723.....	HMD200.....	156
469724.....	HMD400.....	156

HANDGARD ECLIPSE

488649.....	304340172.....	306
488650.....	304340173.....	306
484341.....	304340182.....	306
484342.....	304340183.....	306
488679.....	304750142.....	306
488680.....	304750143.....	306

MANUFACTURER NUMERICAL INDEX

Item # Mfg. # Page #

HANDI-FOIL

476077.....	11205.....	304
476079.....	51805.....	304
476080.....	51808.....	304
476129.....	4020-70-50.....	304

HANDY WACKS

388931.....	EZ-12N.....	304
388933.....	EZ-8N.....	304
388936.....	FW-12.....	304
388937.....	FW-15.....	304
397196.....	HDT-8M.....	304
388944.....	PL-25-1.....	304

HAVELLS / SLI

388037.....	00156.....	301
494216.....	03509.....	301
380532.....	16683.....	301
380558.....	16685.....	301
380559.....	16687.....	301
380565.....	17526.....	301
380566.....	17527.....	301
483193.....	26158.....	301
380579.....	30530.....	301
380992.....	30534.....	301
380585.....	30545.....	301

JACCARD

483079.....	200316.....	216
483080.....	200348.....	216
483083.....	200441.....	215
483086.....	200817.....	216
483087.....	200819.....	215
483081.....	200315NS.....	216
483082.....	200345NS.....	216
483085.....	200414A.....	216
483084.....	200441C.....	215

JOHNSON DIVERSEY

369286.....	90139.....	309
369317.....	90221.....	155
369268.....	90223.....	155
369257.....	90224.....	155
369279.....	90940.....	309
369274.....	91206.....	308
369162.....	91209.....	308
369403.....	94430.....	310
474061.....	4203286.....	310

LIBBEY

399411.....	13.....	24
388101.....	14.....	24
372438.....	15.....	24
370542.....	18.....	24
369375.....	19.....	24
372485.....	44.....	21
369579.....	48.....	23
369271.....	53.....	21
369357.....	96.....	21
455745.....	123.....	19
370318.....	124.....	19
456252.....	125.....	19
388102.....	126.....	19
446314.....	127.....	19
388689.....	128.....	19
457012.....	132.....	19
388107.....	133.....	19
465016.....	135.....	20
369661.....	139.....	19
370505.....	151.....	19
370511.....	155.....	23
370618.....	158.....	19
456253.....	159.....	19
370596.....	161.....	19
370868.....	170.....	19
455753.....	172.....	19

Item # Mfg. # Page #

370161.....	176.....	24
451267.....	178.....	24
402449.....	179.....	24
452922.....	181.....	24
370210.....	183.....	24
370216.....	194.....	25
489927.....	217.....	15
458329.....	221.....	15
458330.....	222.....	15
444512.....	223.....	20
461169.....	224.....	15
388103.....	225.....	20
388109.....	226.....	20
370342.....	227.....	20
456251.....	232.....	20
488384.....	247.....	25
388104.....	259.....	20
395258.....	400.....	15
435120.....	401.....	15
442425.....	402.....	15
434201.....	403.....	15
370103.....	718.....	31
371313.....	719.....	31
369352.....	763.....	30
370193.....	789.....	31
370193.....	789.....	154
370324.....	795.....	31
370324.....	795.....	154
480549.....	1604.....	25
368644.....	1610.....	25
386504.....	1611.....	25
406181.....	1623.....	25
369676.....	1965.....	30
431878.....	2212.....	16
370260.....	2303.....	23
369513.....	2310.....	14
370124.....	2318.....	14
369578.....	2325.....	14
369526.....	2328.....	14
369233.....	2338.....	14
369256.....	2339.....	14
370123.....	2349.....	14
370138.....	2359.....	14
369536.....	2369.....	14
391456.....	2392.....	12
370881.....	2478.....	25
369524.....	2481.....	13
370518.....	2484.....	13
369270.....	2485.....	13
369582.....	2486.....	13
369446.....	2488.....	13
369441.....	2489.....	13
370867.....	2824.....	30
394369.....	3010.....	12
370219.....	3011.....	12
369641.....	3014.....	11
370455.....	3056.....	11
368794.....	3057.....	11
406636.....	3060.....	12
370539.....	3064.....	11
370312.....	3065.....	11
373776.....	3088.....	12
385990.....	3096.....	12
455342.....	3211.....	13
368805.....	3212.....	13
369293.....	3228.....	13
370446.....	3264.....	13
370578.....	3312.....	12
369438.....	3364.....	12
369442.....	3402.....	15
369601.....	3403.....	15
386111.....	3407.....	15
370162.....	3408.....	15
370253.....	3537.....	14
370499.....	3556.....	14
369420.....	3616.....	16
370184.....	3617.....	16

Item # Mfg. # Page #

370382.....	3623.....	16
433733.....	3701.....	23
369631.....	3702.....	5
369332.....	3704.....	5
369167.....	3705.....	5
369522.....	3708.....	5
370327.....	3709.....	5
452469.....	3711.....	5
452220.....	3712.....	5
369229.....	3715.....	7
370115.....	3716.....	7
369172.....	3717.....	7
369195.....	3721.....	7
370899.....	3725.....	5
438414.....	3727.....	5
452225.....	3728.....	5
453268.....	3730.....	5
417899.....	3733.....	6
453245.....	3736.....	6
450264.....	3737.....	6
454341.....	3746.....	5
453264.....	3747.....	5
372891.....	3750.....	7
452223.....	3756.....	5
368727.....	3757.....	4
452222.....	3764.....	4
452921.....	3765.....	4
368807.....	3766.....	4
455743.....	3769.....	4
369269.....	3771.....	6
369160.....	3773.....	6
368674.....	3777.....	6
370183.....	3779.....	6
450753.....	3788.....	6
370412.....	3790.....	6
370240.....	3792.....	6
370494.....	3793.....	6
369555.....	3794.....	6
369175.....	3795.....	6
369308.....	3796.....	7
369540.....	3810.....	26
370269.....	3812.....	26
370281.....	3815.....	26
370497.....	3820.....	13
369502.....	3823.....	13
370172.....	3824.....	13
370416.....	3825.....	13
370271.....	3826.....	13
370167.....	3827.....	13
370097.....	3828.....	13
370519.....	3911.....	12
370785.....	3914.....	12
369460.....	3915.....	12
369577.....	3957.....	12
370864.....	3964.....	12
453249.....	3965.....	12
370241.....	3966.....	12
370114.....	3969.....	12
370211.....	3996.....	12
447742.....	4803.....	25
369197.....	5001.....	27
369393.....	5010.....	27
370180.....	5011.....	26
369519.....	5012.....	26
370582.....	5016.....	27
369610.....	5018.....	27
369529.....	5019.....	27
369154.....	5020.....	27
370603.....	5021.....	27
382015.....	5027.....	27
370396.....	5030.....	23
370181.....	5031.....	23
369547.....	5037.....	30, 135
369408.....	5044.....	31
369557.....	5045.....	30, 135
369203.....	5065.....	30
369389.....	5092.....	27

MANUFACTURER NUMERICAL INDEX

Item #	Mfg. #	Page #	Item #	Mfg. #	Page #	Item #	Mfg. #	Page #
369675.....	5101.....	29	369328.....	8089.....	15	369174.....	15454.....	14
450757.....	5102.....	30	370374.....	8402.....	10	369285.....	15456.....	14
434202.....	5103.....	30	370365.....	8405.....	10	369231.....	15457.....	14
370248.....	5109.....	24	369252.....	8411.....	10	368699.....	15458.....	14
388105.....	5110.....	29	368634.....	8412.....	11	369467.....	15459.....	14
369417.....	5115.....	29	370165.....	8413.....	17	370391.....	15463.....	14
369365.....	5118.....	29	369173.....	8414.....	10	370169.....	15464.....	14
369334.....	5119.....	29	369205.....	8415.....	11	368665.....	15465.....	14
370458.....	5120.....	23	369657.....	8416.....	17	388112.....	15477.....	18
370337.....	5121.....	23	369451.....	8417.....	17	370358.....	15478.....	17
369443.....	5122.....	23	368718.....	8418.....	17	370369.....	15479.....	18
370343.....	5126.....	23	370204.....	8420.....	17	451027.....	15480.....	17
371204.....	5127.....	23	369430.....	8422.....	17	369341.....	15481.....	17
370107.....	5128.....	23	368660.....	8423.....	17	455744.....	15482.....	17
369574.....	5130.....	20	369223.....	8425.....	11	369169.....	15483.....	17
453590.....	5131.....	20	369655.....	8427.....	17	370601.....	15485.....	17
370284.....	5135.....	23	371316.....	8428.....	11	370395.....	15500.....	29
370311.....	5137.....	22	369201.....	8429.....	11	369517.....	15506.....	28
370178.....	5138.....	23	369264.....	8454.....	11	370095.....	15507.....	28
385622.....	5139.....	22	368704.....	8455.....	11	411731.....	15585.....	22
368642.....	5143.....	31	453258.....	8456.....	10	411733.....	15588.....	22
369163.....	5154.....	31	452221.....	8464.....	11	370270.....	15603.....	18
369380.....	5156.....	31	369370.....	8466.....	10	388100.....	15605.....	18
369404.....	5160.....	30	369215.....	8470.....	10	370223.....	15640.....	18
370177.....	5161.....	30	369395.....	8471.....	10	370427.....	15641.....	18
369180.....	5162.....	30	453592.....	8472.....	10	370179.....	15642.....	18
368651.....	5164.....	31	368724.....	8476.....	11	369560.....	15643.....	18
369486.....	5165.....	31	369326.....	8477.....	11	426122.....	15646.....	25
369619.....	5172.....	31	368711.....	8480.....	17	369608.....	15651.....	4
369456.....	5201.....	28	432444.....	8485.....	17	369535.....	15652.....	4
369217.....	5202.....	26	377479.....	8495.....	11	369435.....	15654.....	4
369228.....	5203.....	26	370237.....	8764.....	10	370189.....	15656.....	4
368808.....	5205.....	26	369556.....	8795.....	10	370875.....	15659.....	4
368692.....	5206.....	27	369421.....	8876.....	16	370360.....	15661.....	4
369497.....	5210.....	25	413030.....	8883.....	16	390501.....	15665.....	3
369570.....	5212.....	25	369672.....	8941.....	10	406640.....	15673.....	4
370291.....	5213.....	28	369498.....	8956.....	10	451129.....	15709.....	18
369653.....	5221.....	30, 135	371309.....	8978.....	10	451868.....	15710.....	18
369183.....	5258.....	30, 87	369468.....	8995.....	10	459085.....	15711.....	18
369378.....	5260.....	31	387219.....	15141.....	22	460266.....	15712.....	18
369447.....	5262.....	27	369184.....	15231.....	3	451127.....	15713.....	18
369189.....	5265.....	31	369288.....	15232.....	3	460569.....	15714.....	18
369161.....	5272.....	27	370160.....	15233.....	3	450509.....	15715.....	18
370249.....	5273.....	27	369156.....	15235.....	3	475965.....	15720.....	18
370250.....	5293.....	28	369171.....	15236.....	3	437931.....	15722.....	22
369181.....	5294.....	28	368721.....	15237.....	3	386805.....	23106.....	20
368655.....	5295.....	28	368799.....	15238.....	3	452023.....	23186.....	20
369359.....	5297.....	26	369198.....	15239.....	3	449713.....	23236.....	20
369343.....	5298.....	26	368708.....	15240.....	3	454343.....	23256.....	20
370538.....	5304.....	28	369243.....	15241.....	3	458820.....	23286.....	20
369669.....	5307.....	26	368715.....	15242.....	3	455335.....	23386.....	20
369218.....	5309.....	26	368694.....	15243.....	3	370399.....	23396.....	20
369550.....	5310.....	29	368798.....	15244.....	3	455405.....	23596.....	20
369278.....	5314.....	29	371321.....	15245.....	3	370352.....	32802.....	21
370173.....	5315.....	29	370267.....	15246.....	4	370569.....	37179.....	16
370154.....	5317.....	30	368714.....	15247.....	4	411567.....	37339.....	16
370587.....	5355.....	27	369240.....	15248.....	3	369646.....	37719.....	16
373236.....	5360.....	26	369505.....	15249.....	3	369603.....	37799.....	16
387220.....	5362.....	26	368697.....	15253.....	4	379625.....	70017.....	135
381932.....	5364.....	26	388106.....	15256.....	3	369414.....	70022.....	30, 135
369537.....	5460.....	30, 87	370188.....	15411.....	29	420879.....	70855.....	15
369650.....	6425.....	25	369323.....	15412.....	29	370137.....	75305.....	30
406634.....	7500.....	8	370532.....	15427.....	28	368680.....	97000.....	31, 154
406359.....	7502.....	8	389014.....	15429.....	4	369479.....	97001.....	31, 154
401940.....	7503.....	8	371342.....	15430.....	19	370148.....	97036.....	27
406633.....	7504.....	8	370086.....	15431.....	18	370120.....	97038.....	24
406362.....	7505.....	9	370425.....	15432.....	18	369305.....	97052.....	30, 135
406635.....	7507.....	16	370381.....	15433.....	19	369649.....	97084.....	27
402722.....	7508.....	8	369429.....	15434.....	19	369422.....	97085.....	27
402725.....	7509.....	8	369674.....	15435.....	19	371399.....	1722471.....	25
402726.....	7510.....	8	369190.....	15436.....	19	376565.....	1767591.....	20
410327.....	7511.....	16	369225.....	15437.....	19	375984.....	1785473.....	25
411639.....	7512.....	9	369432.....	15445.....	30, 90	429127.....	1787386.....	24
425775.....	7513.....	9	369260.....	15446.....	30, 90	417894.....	1788490.....	28
411651.....	7551.....	8	369470.....	15447.....	30, 90	417635.....	1788491.....	28
439103.....	7552.....	8	369553.....	15451.....	14	381990.....	9520003.....	31
410673.....	7700.....	16	369508.....	15453.....	14	370310.....	9520004.....	31

MANUFACTURER NUMERICAL INDEX

Item #	Mfg. #	Page #
370558	9570101	15
369549	9860594	20
377096	9862324	23
472348	08743/07	7
472332	08745/07	7
412614	1013HT	24
370564	1176HT	24
452022	1178HT	24
452226	1181HT	24
370457	1183HT	24
388110	1240HT	24
419542	1242HT	25
370475	1451HT	21
428901	1453HT	21
388111	1454HT	21
369220	14801HT	25
370174	14806HT	25
369678	1637HT	22
369193	1639HT	22
370228	1650SR	23
370135	1654SR	20
370225	1660SR	20
370145	1661SR	20
388099	1713HT	21
370390	171B	21
369209	1906HT	22
458817	1910HT	22
369476	1917HT	22
369364	29011HT	22
369347	29211HT	22
458822	29411HT	22
463668	29511HT	22
460213	29811HT	22
369262	3619JS	16
369635	3620JS	16
370316	3649LS	16
453254	3752HT	6
370232	5120A0007	23
370134	5121S0711	23
369350	5122S0709	23
369545	5126A0007	23
370205	5126S0711	23
371205	5127S0710	23
370191	5135S0617	23
370443	5213B	28
442295	53/11680	21
370438	539HT	21
452224	606HT	21
369489	610HT	21
447746	618HT	21
369425	633HT	21
451172	7510SR	9
411641	7555SR	9
413395	7700BS-BlueStem	16
370389	814CD	19
370366	817CD	19
415853	8513SR	9
370287	8515SR	9
370535	8541SR	9
370197	8555SR	9
370345	8556SR	9
370565	8564SR	9
370529	8565SR	9
370357	8572SR	9
370562	8573SR	9
370274	8588SR	9
369405	916CD	19
369221	9171CD	20
371312	917CD	19
440835	96/11680	21
374020	C145ZX	8
371352	C189ZX	7
376195	C211ZX	7
440803	C269ZX	8
433415	C82ZX	7
374968	PM514ZX	8
377051	PM515ZX	8

Item #	Mfg. #	Page #
374970	PM521ZX	8
MUNDIAL		
483539	5158	201
483521	5518	200
483515	3303-12	201
483522	3311-12	201
483507	4688M	201
483508	4689M	201
483533	5109-7GE	201
483536	5110-10	201
483535	5110-8	201
483531	5111-6	201
483532	5112-7	201
483534	5121-8E	201
483540	SCWH-9	200
483504	W0547-4	200
483495	W0547-4E	200
483505	W5601-3 1/4	200
483485	W5604-7GE	200
483490	W5607-6	200
483502	W5610-10	200
483478	W5610-10E	200
483493	W5610-12	200
483501	W5610-8	200
483476	W5610-8E	200
483479	W5613-8	200
483492	W5614-6	200
483471	W5614-8	200
483496	W5615-6 1/4	200
483480	W5617-10	200
483477	W5620-7E	200
483499	W5620-9E	200
483497	W5621-10	200
483494	W5622-6E	200
483475	W5625-10	200
483482	W5626-7 1/2	200
483503	W5627-10E	200
483484	W5627-12E	200
483474	W5627-12GE	200
483523	W5650-6	201
483516	W5654-12	201
483506	W5680-6 1/2	200
483520	W5681	201
483527	W5683	201
483524	W5685	201
483514	W5686	201
483518	W5687	201
483526	W5688-3 1/2	201
483529	W5688E-3 1/2	201
483519	W5689	201
483525	W5691-4	201
483509	W5692-3	201
483510	W5692-4	201
483517	W5694	201
483511	W5695	201
483528	W5697	201
483513	W656	201

NATIONAL CHECKING

412456	1300SP	303
412458	1441SP	303
412460	2300SP	303
442526	7225-80SP	303
385779	7225SP	303
374617	7313SP	303
467018	D1KIT	191
467008	DISP7R-1	191
466938	DP12R	191
466939	DSL23R	191
412446	G3616	303
412447	G3632	303
412450	G6000	303
412451	G7000	303
467006	LL7R-1	191
481152	LL7R-2	191

Item #	Mfg. #	Page #
466873	P101R	191
466874	P102R	191
466875	P103R	191
466876	P104R	191
466877	P105R	191
466878	P106R	191
466879	P107R	191
467016	P1KIT	191
466866	P7501R	191
466867	P7502R	191
466868	P7503R	191
466869	P7504R	191
466870	P7505R	191
466871	P7506R	191
466872	P7507R	191
466888	R101R	191
466889	R102R	191
466890	R103R	191
466891	R104R	191
466892	R105R	191
466893	R106R	191
466894	R107R	191
467017	R1KIT	191
481153	R2KIT	191
466925	RIPU24R	191
466911	RP12R	191
466924	RSL24R	191
466895	RUF2R	191

NEMCO FOOD EQUIPMENT

423095	6015	114
423095	6015	165
476270	6200	176
423091	6215	168
457673	6403	169
488912	6430	171
531736	6431	171
423276	6451	169
476268*	6457	170
523553	6600	177
457653	56029	247
423269	428-8	212
423265	436-1	213
423266	436-2	213
423270	466-1	211
423271	466-2	211
423050	55050AN	213
423064	55200AN	212
431514	55417	213
459651	55424-2	213
423066	55450-1	213
423068	55450-2	213
423069	55500-1	213
423070	55500-2	213
423071	55550-6	212
423072	55550-8	212
423073	55600-1	211
423074	55600-2	211
423275	55607-6	282
423075	55650	214
423076	55700	214
459657	55727-8	213
423082	55825	282
453582	56050-1	247
457670	56500-1	213
432435	56500-2	213
476272	56600-1	211
423083	6000A-2	165
423085	6055A	166
423086	6100A	166
423087	6101A	166
423088	6150-36	165
423089	6150-48	165
423096	6310-2	166
531734	6480-301	171
531733	6480-30S	171

MANUFACTURER NUMERICAL INDEX

Item #	Mfg. #	Page #
531735	6480-361	171
529094	6480-36S	171
476271*	6510-D7	170
476264*	8027-SBB	169
476263*	8027S-SLT	169
476266*	8036-SBB	169
477635*	8036S-SLT	169
430984	8150-RS	217

O'CEDAR COMMERCIAL

427994	6208	293
399834	6516	290
423520	91282	293
380252	91284	293
402102	91351	293
514347	94201	290
380254	94205	290
380313	96024	292
380319	96036	292
380257	96071	294
380259	96073	294
380326	96124	292
380329	96136	292
425060	96142	281
380332	96161	292
399851	96175	295
421675	96208	292
399849	96243	294
464557	96301	296
464558	96311	296
515654	96312	280
424877	96420	292
380270	96501	280
380281	96511	280
399835	96516	290
380290	96619	294
460975	96975	291
429480	96978	291
460022	96991	291
380504	97160	294
480841	97518	290
459538	97560	294
423839	000226	290
380246	6120-6	293
427995	6200-6	293
380243	6301-6	293
380249	6400-6	293
380292	96818-S	295
380295	96823-S	295
399844	97113-3	290
399826	97147-3	290
399827	97157-3	290
399842	97232-NB-3	290
472098	97412-3	290
399846	97413-3	290
429491	97613V-3	290
399822	97716V-3	290
399841	97720V-3	290
399823	97724V-3	290
399824	97732V-3	290
412434	97822-3	290
399831	97831-3	290
399825	97924-3	290

ONEIDA

370706	2201FDNF	94
380999	2201FSLF	94
381005	2201KPVF	94
381001	2201SBLF	94
381003	2201SITF	94
381000	2201STSF	94
386183	2272FDIF	95
402771	2272FSLF	95
402773	2272KPVF	95
402769	2272SBLF	95
383021	2272STSF	95
371472	2347FPLF	94

372903	2347FSLF	94
371471	2347KPVF	94
372904	2347SRBF	94
372908	2347STSF	94
369004	2544FRSF	95
370700	2544FSLF	95
368994	2544KPVF	95
369010	2544SBLF	95
369008	2544SPLF	95
381009	2544STBF	95
369002	2544STSF	95
369006	2552FRSF	95
372911	2552FSLF	95
369005	2552KPVF	95
372910	2552SBLF	95
369007	2552STSF	95
369003	2610FRSF	94
381011	2610FSLF	94
372506	2610KPVF	94
370687	2610SBLF	94
369009	2610STSF	94
389357	B070FPLF	99
389358	B070KPVF	99
389367	B070SBLF	99
389369	B070SPLF	99
389370	B070STSF	99
463755	B072FOYF	99
381375	B072FPLF	99
394605	B072FSLF	99
381379	B072KPVF	99
463747	B072SADF	99
458249	B072SBLF	99
381383	B072SITF	99
463749	B072SPLF	99
381382	B072STSF	99
420379	B080FPLF	96
420381	B080KPVF	96
420382*	B080SBLF	96
420386	B080STSF	96
415320	B120FDNF	96
415319	B120KPTF	96
424852	B167FDEF	97
424853	B167FDNF	97
424855	B167KPTF	97
423213	B167SRBF	97
424857	B167STSF	97
423209	B169FDEF	97
415356	B169FDIF	97
424858	B169KPTF	97
423210	B169SDEF	97
424865	B169SRBF	97
424866	B169STSF	97
427635	B196FPLF	97
427873	B196KPVF	97
432488	B196SBLF	97
427880	B196STSF	97
427881	B230FOYF	99
389396	B230FPLF	99
427882	B230SFLF	99
389397	B230KPVF	99
389398	B230SBLF	99
427883	B230SDEF	99
389399	B230SITF	99
389400	B230STSF	99
368974	B393FPLF	97
370684	B393KPVF	97
370686*	B393SBLF	96
368999	B393STSF	97
381384	B401FOYF	100
381385	B401FPLF	100
381386	B401FSLF	100
381387	B401KGWF	100
381388	B401SBLF	100
381393	B401SITF	100
381389	B401SPLF	100
483935	B401STBF	100
381392	B401STSF	100

381395	B421FOYF	100
381396	B421FPLF	100
381397	B421FSLF	100
381399	B421KGWF	100
381400	B421SBLF	100
381403	B421SITF	100
381401	B421SPLF	100
381402	B421STSF	100
389419	B561FDNF	98
389421	B561FSLF	98
389422	B561KPNF	98
389423	B561SBLF	98
389425	B561SPLF	98
389426	B561STSF	98
381354	B595FDNF	99
381355	B595FOYF	99
381356	B595FSLF	99
381357	B595KPVF	99
381358	B595KSBF	99
381359	B595SBLF	99
381360	B595SDEF	99
381362	B595SITF	99
381361	B595STSF	99
381365	B606FDNF	99
381366	B606FOYF	99
381367	B606FSLF	99
381368	B606KPVF	99
381370	B606SBLF	99
381371	B606SDEF	99
381373	B606SITF	99
381374	B606STBF	99
381372	B606STSF	99
389564	B614KSSF	108
389565	B615KSSF	108
390374	B616KSSF	108
389566	B617KSSF	108
389567	B618KSSF	108
389455	B760FDNF	98
431611	B760KPVF	98
389460	B760SBLF	98
389461	B760SDEF	98
389462	B760SITF	98
389463	B760STSF	98
417779	B763FDIF	100
389469	B763KPVF	100
389470	B763SBLF	100
427930	B763SITF	100
389471	B763STSF	100
389472	B767FDNF	100
389473	B767KPVF	100
389474	B767SBLF	100
389576	B767SDEF	100
427933	B767SITF	100
389475	B767STSF	100
389569	B770KSHH	108
389571	B770KSSG	108
389573	B770KSSK	108
419846	B770KSSN	108
389575	B770KSSJ	108
389616	B817FDNF	98
389482	B817FDNG	98
389617	B817FOYF	98
389483	B817FSLG	98
389625	B817KPVF	98
389619	B817KPVF	98
389624	B817KSHF	98
389620	B817SBLF	98
389621	B817SITF	98
389622	B817SPLF	98
389623	B817STSF	98
382919*	F100000116	66
405683	F100000134	66
394620	F1000000500	66
405689	F1000000528	66
405693	F1000000700	66
372921	F1000000705	66
405694*	F1000000740	66

MANUFACTURER NUMERICAL INDEX

Item #	Mfg. #	Page #	Item #	Mfg. #	Page #	Item #	Mfg. #	Page #
372927	F1000000765	66	495120*	F5010000760	67	388616	R4480000117	69
386795	F1000000790	66	495121*	F5010000765	67	388617	R4480000127	69
369021	F1040000117	64	495102*	F5020000120	67	388827	R4480000139	69
369642	F1040000125	64	495103*	F5020000127	67	388828	R4480000143	69
369027	F1040000139	64	495104*	F5020000131	67	388618	R4480000151	69
390053	F1040000145	64	495105*	F5020000148	67	388619	R4480000163	69
369035	F1040000149	64	495106*	F5020000155	67	388829	R4480000347	69
369627	F1040000163	64	495107*	F5020000167	67	388830	R4480000361	69
370734	F1040000361	64	495109*	F5020000343	67	393081	R4480000371	69
369466	F1040000500	64	495110*	F5020000358	67	392058	R4480000387	69
371432	F1040000510	64	495111*	F5020000368	67	388586	R4480000501	69
369459	F1040000520	64	495112*	F5020000391	67	423227	R4480000502	69
372525	F1040000560	64	495097*	F5020000500	67	388834	R4480000505	69
369030	F1040000700	64	495100*	F5020000504	67	423207	R4480000508	69
369629	F1040000710	64	495095*	F5020000506	67	388591	R4480000510	69
369484	F1040000720	64	495096*	F5020000510	67	388833	R4480000525	69
369477	F1040000740	64	495098*	F5020000524	67	423221	R4480000530	69
372837	F1040000760	64	495108*	F5020000563	67	423206	R4480000535	69
408989	F1040728117	65	495093*	F5020000705	67	388835	R4480000560	69
399709	F1040728139	65	495113*	F5020000715	67	457751	R4480000560C	69
397115*	F1040728500	65	495114*	F5020000736	67	388806	R4480000700	69
460516*	F1040728516	65	495115*	F5020000738	67	389141	R4480000711	69
398231	F1040728700	65	495101*	F5020000740	67	388622	R4480000720	69
386815	F1040728710	65	495116*	F5020000758	67	388832	R4480000731	69
386911	F1500000111	64	495119*	F5020000900	67	388807	R4480000733	69
369639	F1500000139	64	495117*	F5020000910	67	457749	R4480000733C	69
371427	F1500000145	64	495118*	F5020000911	67	388623	R4480000740	69
372937	F1500000151	64	369045	R4110000111	70	430205	R4480000740C	69
394631	F1500000156	64	369046	R4110000118	70	388601	R4480000790	69
370711	F1500000342	64	371439	R4110000125	70	388612	R4510000119	65
369604	F1500000359	64	369037	R4110000139	70	388613	R4510000127	65
370713	F1500000501	64	369082*	R4110000150	70	389664	R4510000139	65
378450	F1500000505	64	369040	R4110000359	70	394974	R4510000146	65
372924	F1500000520	64	369024	R4110000710	70	391042	R4510000152	65
378451	F1500000525	64	369656	R4130000111	70	388614	R4510000163	65
370738	F1500000560	64	369025	R4130000139	70	389342	R4510000501	65
369501	F1500000700	64	370928	R4130000145	70	409451	R4510000520	65
369647	F1500000710	64	369079	R4130000149	70	389341	R4510000521	65
372545	F1500000720	64	369085	R4130000500	70	391038	R4510000567	65
370730	F1500000731	64	369088	R4130000510	70	391040	R4510000700	65
420453	F1500000740	64	369059	R4130000560	70	391039	R4510000706	65
370719	F1500000741	64	369069	R4130000561	70	388611	R4510000712	65
369616	F1520000139	66	388585	R4130000562	70	394905	R4510000720	65
370721	F1520000151	66	369063	R4130000700	70	401814	R4510000740	65
369633	F1520000359	66	369053	R4130000711	70	389098	R4520000600	69
369612	F1520000510	66	369018	R4130000720	70	388598	R4520000603	69
426530	F1520000560	66, 85	369060	R4130000731	70	388624	R4530000111	68
370752*	F1560000126	66	369014	R4130000740	70	388625	R4530000117	68
370751*	F1560000144	66	369659	R4130000790	70	388626	R4530000124	68
369033	F1560000346	66	389097	R4170000560	68	388627	R4530000139	68
369023	F1560000360	66	369057	R4170000680	89	388628	R4530000144	68
370731	F1560000500	66	369043	R4178102560	85	439054	R4530000149	68
378411	F1560000520	66	378402	R4238026125	70	398927	R4530000163	68
369609	F1560000710	66	378403	R4238026139	70	388630	R4530000342	68
369617	F19920000560	64	369072	R4238026143	70	388631	R4530000360	68
389129	F2500000117	64	378404*	R4238026150	70	391493	R4530000368	68
389627	F2500000124	64	369042	R4238026359	70	388592	R4530000501	68
378410	F2500000711	64	370849	R4238026501	70	388594	R4530000521	68
370741	F2520000111	66	378405	R4238026510	70	388599	R4530000560	68
388091	F2520000119	66	369050	R4238026560	70	388632	R4530000700	68
369521	F2520000125	66	378407	R4238026710	70	388633	R4530000710	68
482941	F500000117S	65	388816	R4470000111	69	388634	R4530000711	68
480167	F500000149S	65	388810	R4470000119	69	388635	R4530000720	68
495129*	F5010000119	67	430190	R4470000119C	69	388636	R4530000731	68
495130*	F5010000131	67	388814	R4470000125	69	388638	R4530000733	68
495131*	F5010000143	67	430159	R4470000133	69	388639	R4530000740	68
495132*	F5010000149	67	388818	R4470000139	69	388602	R4530000756	68
495133*	F5010000163	67	388808	R4470000143	69	388604	R4530000790	68
495135*	F5010000358	67	398975	R4470000147	69	388642	R4540000111	68
495136*	F5010000368	67	388824	R4470000151	69	388652	R4540000119	68
495126*	F5010000500	67	430193	R4470000151C	69	388653	R4540000127	68
495124*	F5010000505	67	388811	R4470000347	69	388655	R4540000139	68
495125*	F5010000530	67	388809	R4470000359	69	388656	R4540000143	68
495123*	F5010000535	67	430195	R4470000359C	69	388657	R4540000151	68
495134*	F5010000705	67	388825	R4470000371	69	388659	R4540000343	68
495128*	F5010000740	67	388812	R4470000711	69	388661	R4540000359	68
495127*	F5010000758	67	388826	R4480000111	69	388662	R4540000373	68

MANUFACTURER NUMERICAL INDEX

Item #	Mfg. #	Page #
388663.....	R4540000711.....	68
413794.....	T015FDEF.....	95
409447.....	T015FDIF.....	95
383606.....	T015FOYF.....	95
371522.....	T015FSLF.....	95
409448.....	T015KDVF.....	95
434741.....	T015KSBG.....	95
371521.....	T015SADF.....	95
409446.....	T015SBLF.....	95
383609.....	T015SDEF.....	95
383607.....	T015SITF.....	95
409449.....	T015STBF.....	95
383614.....	T015STS.....	95
415321.....	T120STS.....	96
419331.....	T148FDEF.....	96
414118.....	T148FDIF.....	96
419332.....	T148FOYF.....	96
414117.....	T148FSLF.....	96
420853.....	T148KBBF.....	96
420852.....	T148KDVF.....	96
414119.....	T148KPSG.....	96
419333.....	T148SADF.....	96
414115.....	T148SDEF.....	96
414116.....	T148SITF.....	96
414112.....	T148STS.....	96
446312.....	T168FDEF.....	96
433225.....	T168FDIF.....	96
433226.....	T168KPTF.....	96
433223.....	T168STS.....	96
444419.....	T672FDEF.....	94
444418.....	T672FDIF.....	94
444420.....	T672KPTF.....	94
466722.....	T672SRBF.....	94
444416.....	T672STS.....	94

ORECK COMMERCIAL

423475.....	30.0604.....	287
531721*.....	550MC.....	288
538783*.....	A Package.....	288
432386.....	AM10.D.....	288
538784*.....	B Package.....	288
423465.....	BB900DGR.....	287
520385*.....	OR102.....	287
464485.....	PK10PR014DW.....	287
423470.....	PK8000.25.....	287
423474.....	PKBP10.10QT.....	287
531718*.....	PPS29.....	286
423468.....	PR2600.....	288
423469.....	PR3200.....	288
538497.....	PR9100NM.....	288
538780.....	U2000EB.....	287
463317.....	UPRO14T.....	287
538782*.....	XLPRO6A.....	287

PROCTOR & GAMBLE

339479.....	02010.....	309
325020.....	02280.....	309
342832.....	02287.....	309
325159.....	02364.....	310
325052.....	02613.....	310
444651.....	03561.....	303
444655.....	04061.....	303
444648.....	09061.....	303
444649.....	09161.....	303
444650.....	09261.....	303
444652.....	09361.....	303
444653.....	15261.....	303
373400.....	31240.....	310
435714.....	45112.....	310
435715.....	45114.....	310

R.H. FORSCHNER/ VICTORINOX

379750.....	40001.....	209
379755.....	40002.....	209

Item #	Mfg. #	Page #
379760.....	40003.....	209
379766.....	40007.....	209
379772.....	40013.....	209
379785.....	40020.....	209
379788.....	40021.....	209
379802.....	40022.....	209
379807.....	40023.....	209
379812.....	40027.....	209
379820.....	40040.....	209
379832.....	40084.....	209
379846.....	40199.....	209
379872.....	40501.....	210
379879.....	40511.....	210
379891.....	40520.....	210
379896.....	40521.....	210
379899.....	40547.....	210
379903.....	40548.....	210
379920.....	40549.....	210
379923.....	40584.....	210
379926.....	40586.....	210
379930.....	40600.....	210
379932.....	40602.....	210
379934.....	40640.....	210
379937.....	40645.....	210
400091.....	40646.....	210
402218.....	41998.....	199
400087.....	45896.....	199
379938.....	46050.....	209
379939.....	46550.....	209
431541.....	47525.....	210
431542.....	47552.....	210
431534.....	47603.....	210
431535.....	47620.....	210
431537.....	47621.....	210
379940.....	86003.....	199
379941.....	86004.....	199
431284.....	86502.....	199
379942.....	86503.....	199
379943.....	86504.....	199
431285.....	86505.....	199

RECKITT-BENCKISER

349453.....	02775.....	309
257053.....	04250.....	308
349458.....	04650.....	310
343537.....	74017.....	309
349465.....	74278.....	310
349449.....	74411.....	309

SAN JAMAR

380950.....	B4186L.....	149
380949.....	B4300.....	150
380947.....	B5532.....	150
380948.....	B5542.....	150
409266.....	B6180.....	149
380946.....	B6183L.....	149
431041.....	BD4005S.....	149
430758.....	BD4006S.....	149
431447.....	BD4014.....	149
395868.....	BR24.....	190
380940.....	C2410C.....	142
380941.....	C2410SM.....	142
380929.....	C3200P.....	142
380930.....	C3400P.....	142
380931.....	C3500P.....	142
380934.....	C3620.....	142
429451.....	C4400PF.....	142
397877.....	CB121812WH.....	197
397644.....	CB1218KC.....	197
397986.....	CB152012RD.....	197
397884.....	CB152012WH.....	197
397678.....	CB1520KC.....	197
397889.....	CB182412BL.....	197
397892.....	CB182412GN.....	197
397893.....	CB182412RD.....	197
397887.....	CB182412WH.....	197

Item #	Mfg. #	Page #
397894.....	CB182412YL.....	197
397684.....	CB1824KC.....	197
399224.....	CBM1622.....	197
380944.....	CK6524A.....	146
380945.....	CK6536A.....	146
380926.....	H3001BKC.....	141
380928.....	H3001CLBK.....	141
454684.....	H5001SCL.....	141
416148.....	IC2200SM.....	142
395928.....	KA3200.....	272
397616.....	KA3244.....	272
395929.....	KA4400.....	272
395926.....	KA600.....	272
465320.....	KK401.....	295
514190.....	KLP200.....	150
395922.....	KLRST.....	197
397797.....	KM1100.....	284
397800.....	KM1200.....	284
397801.....	KM2100.....	284
395915.....	KP196GN.....	189
395911.....	KP196RD.....	189
537133.....	KP256GN.....	189
397895.....	KP256RD.....	189
430527.....	KP500.....	189
395912.....	KP97GN.....	189
395910.....	KP97RD.....	189
445406.....	KT0112K.....	264
380937.....	L1014.....	142
380935.....	L3402.....	142
445402.....	MK0901.....	193
432342.....	MK0906.....	193
389741.....	P7300.....	254
389743.....	P7500.....	254
380942.....	P9800.....	254
380943.....	P9810.....	254
452576.....	PL0103.....	148
445403.....	PL0402.....	148
414146.....	R2790TBK.....	298
380921.....	R4000TBK.....	298
516304.....	RCU128V2.....	190
515534.....	RCU64V2.....	190
395917.....	RP15.....	249
419687.....	S30TBK.....	298
458153.....	S890TBK.....	298
395880.....	SI2000.....	189
430371.....	SI5000.....	153
430369.....	SI5500.....	153, 189
395927.....	SI6000.....	153, 189
537492.....	SI6100.....	153, 189
453718.....	SI7000.....	189
449099.....	SI9000.....	189
460601.....	SI9500.....	189
484681.....	SW1218.....	190
389733.....	T1100WH.....	299
389734.....	T1290TBK.....	299
389735.....	T1790TBK.....	299
414870.....	TST9343.....	183, 190
395905.....	UL5403.....	148
395900.....	UL5405.....	148

SERVING SOLUTIONS

392735.....	NPL61000003.....	143
392742.....	NPL61000004.....	143
392746.....	NPL61000008.....	143
392749.....	NPL61000042.....	143
392745.....	NPL61000078.....	143
392743.....	NPL61000095.....	143
396692.....	NPL61500001.....	143
396693.....	NPL61500016.....	143
396695.....	NPL61800010.....	143
396694.....	NPL61800014.....	143

SHEILA SHINE

521390.....	10.....	309
521389.....	32.....	309
521388.....	128.....	309

MANUFACTURER NUMERICAL INDEX

Item #	Mfg. #	Page #
SMITH LEE		
399420	D3010110	306
399421	D3010112	306
399417	D301015	306
399418	D301016	306
399419	D301018	306
399507	PM30659	306
399504	PM32051	306
399506	PM32052	306
399510	PP37640	306

Item #	Mfg. #	Page #
SPECTRUM		
446488	11-10093	307
446487	11-10096	307
484261	11-10395	307
485935	11-10496	307
406707	C242406N	307
406706	C243306NP	307
406701	C243308N	307
406703	C303710N	307
406710	C334011N	307
406708	C334016N	307
407179	C366017N	307
406704	C386014N	307
406697	C386017N	307
406702	C404812N	307
406699	C404816N	307
406705	C434816N	307

Item #	Mfg. #	Page #
STERNO GROUP		
368015	220	126
367900	221	126
382017	601	125
487260	603	125
459619	808	126
444486	812	126
367918	834	126
406597	837	126
367909	840	126
367936	897	126
466955	1200AM	126
378930	231RD	126
505244	234FR-6	126
505242	234RD-6	126
385237	234V	126
377374	234V-1-AM	126
387227	234V-1-BL	126
378924	234V-1-GR	126
371379	234V-1-RD	126
378936	234V-4	126
452272	3505AF	126
370575	494-CL	126
367907	505TL	125
370483	508FW	125
381826	510FW	125
374173	516FW	125
439791	516FW2	125
372372	530A	125
385502	530A8	125
383778	530F	125
382021	610WH	125
382022	612RD	125
382023	612WH	125
382024	615WH	125
396011	820M	126
368007	HF03003	112, 302
378937	HF03007	112, 302
367903	HF03008	112, 302
367910	HF03108	112, 302
409315	HW03002	112, 302
409316	HW03004	112, 302
409317	HW03006	112, 302
367902	ST03009	112, 302
367942	ST04006G	112, 302
367901	ST04008G	112, 302
367972	ST04028	112, 302

Item #	Mfg. #	Page #
458302	ST04043	112, 302
367959	ST05006	112, 302
406939	ST05008	112, 302
458303	ST05009	112, 302
367921	ST05010	112, 302
367905	ST05016	112, 302
487134	ST05017	112, 302
444707	ST06000	113
510062	ST06003	113
510060	ST06004	113
530754	ST06005	113
514407	ST07000	111, 302

Item #	Mfg. #	Page #
SYRACUSE BY LIBBEY		
508093	903032001	77
508094	903032003	77
508095	903032008	77
508096	903032010	77
508097	903033001	77
508098	903033003	77
508099	903033008	77
508100	903033010	77
508101	903034001	77
508102	903034003	77
508103	903034008	77
508104	903034010	77
508105	903035001	77
508106	903035003	77
508107	903035008	77
508108	903035010	77
508138	905356825	77
508139	905356832	77
508142	905356835	77
508144	905356836	77
508145	905356840	77
508147	905356848	77
508148	905356894	77
508124	911194002	76
508125	911194005	76
508127	911194006	76
508129	911194007	76
508131	911194015	76
508132	911194017	76
508133	911194018	76
508134	911194024	76
508137	911194028	76
508149	950002504	77
508150	950002505	77
508151	950002523	77
508152	950002589	77
508109	950027733	87
508110	950027739	87
508111	950027742	87
508112	950027747	87
508113	950038005	76
508114	950038007	76
508115	950038059	76
508116	950038127	76
508117	950038155	76
508118	950038261	76
508119	950038285	76
508120	950038310	76
508121	950038333	76
508122	950038387	76
508126	950038431	76
508083	950041080	75
508088	950041111	75
508089	950041436	75
508090	950041519	75
508091	950041521	75
508092	950041526	75

Item #	Mfg. #	Page #
T&S BRASS		
476153	001121-45	275
476152	007861-45	275
476168	062X	274

Item #	Mfg. #	Page #
476167	068X	274
476154	B-0044-H	275
476149	B-0107	275
476150	B-0107-C	275
476157	B-0109-01	275
476155	B-0113-B	275
476156	B-0133-B	275
481534	B-0155	274
476160	B-0231	274
476151	B-10K	275
476159	B-1127	274
476158	B-1210	274
476162	B-1255	274
538941	B-1256	274
476161	BR10	275
487149	HG-4C-48SK	173
487148	HG-4D-48SK	173

Item #	Mfg. #	Page #
TABLECRAFT		
423830	5	243
380463	15	247
380352	21	144
397418	23	144
380467	24	144
476688	40	234
476691	41	234
380455	44	216
537754	45	216
389081	65	145
389082	66	145
413301	67	145
380474	76	152
380475	77	152
380447	82	219
380448	84	219
380449	87	218
380476	95	152
380450	96	218
380451	98	218
380452	99	218
380468	101	150
399875	171	145
399874	172	145
423845	174	136
397470	177	282
397378	205	119
380214	206	119
380215	208	119
380216	210	119
380217	212	119
397944	221	141
423843	236	141
489258	242	261
380488	295	151
380464	310	220
380465	312	220
380443	349	219
397391	376	152
380487	395	150
380188	406	133
380466	407	247
380189	414	133
380438	433	242
380439	434	242
380440	435	242
380219	442	130
380220	444	130
380221	447	130
409024	474	130
429962	477	130
380477	512	152
380303	514	137
380479	517	152
484284	518	146
380495	575	154
380178	600	133

MANUFACTURER NUMERICAL INDEX

Item #	Mfg. #	Page #	Item #	Mfg. #	Page #	Item #	Mfg. #	Page #
380480.....	605.....	153	395328.....	1079FG.....	140	380485.....	501K.....	152
380481.....	612.....	153	389134.....	1079R.....	140	380473.....	526T.....	152
380482.....	624.....	153	380152.....	1084BK.....	140	380180.....	55S-1.....	136
380483.....	658.....	153	380154.....	1084FG.....	140	397373.....	56C.....	87
380208.....	662.....	254	380155.....	1084R.....	140	380181.....	57S-1.....	136
380469.....	666.....	149	436509.....	1086BK.....	140	380173.....	591C.....	134
414588.....	667.....	149	432211.....	1086FG.....	140	380174.....	593R.....	134
438828.....	671.....	151	391563.....	1086R.....	140	380175.....	597C.....	134
380420.....	708.....	219	380200.....	108C-1.....	253	484630.....	59BK.....	146
380424.....	713.....	219	380201.....	108K-1.....	253	380179.....	600R.....	133
380430.....	721.....	242	380202.....	108M-1.....	253	405645.....	600ST.....	133
397426.....	722.....	242	380156.....	1117W.....	139	393180.....	65A.....	145
380434.....	724.....	242	448611.....	11253C.....	253	380210.....	662K.....	254
394997.....	821.....	117	380203.....	112C-1.....	253	431453.....	664K.....	254
397429.....	916.....	133	380204.....	112K-1.....	253	402830.....	66A.....	145
380223.....	953.....	132	380205.....	112M-1.....	253	480133.....	714CH.....	141
380222.....	955.....	132	394246.....	11663C.....	253	454345.....	724A.....	242
476692.....	985.....	234	380157.....	1172W.....	139	454344.....	724C.....	242
476693.....	986.....	234	380158.....	1174W.....	139	496978.....	748A.....	255
476694.....	987.....	234	380159.....	1175W.....	139	421450.....	79K.....	138
476695.....	988.....	234	380160.....	1176W.....	139	380182.....	800-1.....	136
380453.....	1023.....	219	407396.....	1188W.....	139	380170.....	83S&P.....	135
397383.....	1053.....	132	465333.....	1189W.....	139	443167.....	90P.....	136
380470.....	1225.....	151	394249.....	12463C.....	253	436322.....	90S.....	136
425193.....	1226.....	151	380206.....	124C-1.....	253	380161.....	917B.....	139
476697.....	1240.....	229	393437.....	1274N.....	139	429450.....	953F.....	132
380185.....	1270.....	133	380164.....	132S&P-2.....	135	380162.....	975B.....	139
380190.....	1370.....	133	380191.....	1370R.....	133	397392.....	B14-49.....	144
414732.....	1472.....	139	431961.....	144GRT.....	63	380186.....	B3650.....	130
380454.....	1610.....	218	380165.....	150S&P-2.....	135	482802.....	BK17209.....	139
454346.....	1710.....	218	538145.....	1524B.....	276	482799.....	BK17409.....	139
530570.....	1800.....	151	491308.....	1524G.....	276	482798.....	BK17410.....	139
438836.....	1805.....	151	417262.....	1527G.....	277	482803.....	BK17508.....	139
476690.....	2455.....	217	380224.....	1529B.....	277	482801.....	BK2679.....	134
475898.....	2472.....	139	380226.....	1529G.....	277	482800.....	BK267912.....	134
433559.....	2474.....	139	380227.....	1529W.....	277	380187.....	BT3650.....	130
420325.....	2476.....	139	399872.....	1531B.....	277	423796.....	C154-12.....	135
399868.....	2675.....	219	399871.....	1531G.....	277	423795.....	C155-12.....	135
380444.....	3004.....	220	390201.....	1531W.....	277	423846.....	C260-4.....	136
423239.....	3005.....	216	380228.....	1537B.....	277	423838.....	C263B-1.....	154
380445.....	3016.....	216	380229.....	1537BR.....	277	423793.....	C406-4.....	133
380446.....	3033.....	220	380230.....	1537G.....	277	423847.....	C57S-4.....	136
399870.....	3306.....	219	380231.....	1537W.....	277	423848.....	C600-4.....	133
476689.....	4040.....	234	388045.....	1547G.....	277	423798.....	C83-12.....	135
458158.....	4060.....	141	380166.....	154S&P-2.....	135	476680.....	CB1218WA.....	197
413157.....	4174.....	139	470259.....	154T.....	135	476682.....	CB1520WA.....	197
397380.....	4175.....	139	380167.....	155S&P-2.....	135	476684.....	CB1824WA.....	197
483097.....	4256.....	151	380168.....	156S&P-2.....	135	389713.....	DBF77.....	195
380457.....	4424.....	217	480535.....	163MPBK.....	135	431473.....	E5600-9.....	199
380471.....	5189.....	153	480537.....	163MPW.....	135	423855.....	E5601.....	215
459646.....	5198.....	153	380172.....	163S&P-2.....	135	439272.....	E5602.....	215
380472.....	5388.....	153	397415.....	166F.....	243	423856.....	E5603.....	215
476685.....	44060.....	235	399065.....	200TC.....	253	423858.....	E5604.....	215
476686.....	44080.....	235	399064.....	2108C-1.....	253	423859.....	E5606.....	215
394214.....	66238.....	254	402228.....	2112C-1.....	253	423860.....	E5607.....	215
397419.....	662110.....	254	399066.....	2124C-1.....	253	423853.....	E5613.....	215
397421.....	662160.....	254	523651.....	2246A.....	151	438957.....	E5614.....	215
391425.....	100TC.....	253	530565.....	2248A.....	151	423861.....	E5616.....	215
399371.....	1071R.....	140	530568.....	2249A.....	151	423854.....	E5627.....	215
461877.....	1073BK.....	139	380183.....	260-1.....	136	423863.....	E5698.....	198
380148.....	1074BK.....	140	386000.....	260R.....	134	469398.....	E5699.....	198
380147.....	1074BR.....	140	380184.....	260SL-1.....	136	380460.....	H158.....	243
380149.....	1074FG.....	140	380491.....	263B-1.....	154	380461.....	H159.....	243
393111.....	1074G.....	140	380492.....	265R-1.....	154	420846.....	H916N.....	133
380150.....	1074R.....	140	457414.....	2912W.....	198	423242.....	H918N.....	133
380151.....	1074Y.....	140	457426.....	2918W.....	198	380405.....	K26.....	253
421388.....	1075R.....	140	380489.....	295R.....	151	506616.....	KK3.....	304
380143.....	1076BK.....	140	380490.....	295X.....	151	380198.....	KK33.....	253
389533.....	1076BL.....	140	380169.....	30S&P.....	135	432715.....	L32.....	255
380142.....	1076BR.....	140	415249.....	31763C.....	253	397451.....	L48.....	255
380144.....	1076FG.....	140	397997.....	3263C.....	253	423862.....	MH-308.....	198
380145.....	1076R.....	140	380207.....	32C.....	253	431474.....	MHOIL.....	198
380146.....	1076Y.....	140	380494.....	341B-1.....	154	380501.....	MW10.....	133
391264.....	1077BK.....	140	412567.....	356DPH.....	132	397445.....	P10.....	133
391125.....	1077FG.....	140	401029.....	35R.....	151	397447.....	P260.....	136
388493.....	1077R.....	140	441766.....	444T.....	130	380192.....	P410A.....	133
391350.....	1079BK.....	140	397060.....	500LC.....	116	380193.....	P410B.....	133

MANUFACTURER NUMERICAL INDEX

Item #	Mfg. #	Page #
380194	P410RE	133
398328	P57S	136
398327	P800	136
439368	PKR-1	199
391328	PM2110	134
380211	PM2112	134
380212	PM2118	134
380486	S209	152
380462	SG201	215

TAYLOR PRECISION INSTRUMENTS

531723	3506	184
532173	3507	185
531725	3512	184
531726	3516	183
531835	5828	188
459650	5831	188
438412	5924	185
398324	5926	184
467548	5932	184
379475	5982	184
486587	6021	185
452529	8767	185
532191	9817	185
379470	9840	183
446502	9998	184
396857	9999	183
379472	3621N	183
451171	5911N	184
379476	5925N	184
379463	5939N	184
379465	5980N	184
379474	5981N	184
379468	5989N	183
379466	6072N	183
379467	6092N	183
379469	6093N	183
398325	6096N	183
532167	8018N	183
469793	9517L	183
405744	9842FDA	183
444144	9848EFDA	183
469792	TE10R	244
460125	TE150	246
487047	TE22	244
487046	TE32C	244
460123	THD32D	245
460122	THD50	245
460121	TP16FF	245
460120	TP32	245
460126	TR250SS	246
460117	TS25KL	245
460115	TS32	245
460116	TS5	245
460118	TS50	245

TEKNOR APEX

379626	724311	286
379624	725369	286

TOLCO CORP

482638	130136	300
482640	160107	299
482639	160162	299
482642	220170	297
482643	220171	297
499464	220200	297
489482	220237	297
489481	220238	297
482646	220300	297
531832	220306	297
531833	220311	298
531834	220314	298
482647	230100	299

Item #	Mfg. #	Page #
482648	230101	299
482649	230108	299
482650	230109	299
482651	230155	298
482652	240103	300
482654	250132	247
482655	280100	296
482656	280102	296
482657	280124	292
482658	280126	292
482659	280137	295
531831	280173	288
482660	280174	296
482661	280175	296
482665	320100	300
482666	320134	300

TRAEX BY LIBBEY

410170	206	133
417380	260	136
380782	1697	271
380875	3670	255
380878	3672	255
380880	3681	255
380903	4135	146
486754	4506	300
486755	4513	300
486756	4515	300
486757	4516	300
486758	4517	300
486759	4521	300
486760	4523	300
486761	4530	300
482580	7022	190
482581	7024	190
482582	1345-05	220
429343	1375-31	276
429342	1520-31	276
429344	1521-31	276
486816	1522-31	276
429345	1527-31	276
380881	2803-18	254
380837	3815-12	141
380822	3825-12	141
419730	4742-06	149
425553	4743-06	149
382405	4748-05	255
382406	4748-18	255
380824	4842-01	255
380826	4843-01	255
436215	4843-06	255
492490	5224-13	253
380848	529-13	134
428563	6010-13	63
380849	602-12	135
429438	709-0605	221
429439	713-0605	221
429442	716-0605	221
380853	802-12	135
429445	809-0605	221
429446	813-0605	221
429447	816-0605	221
429336	TR-1	271
457783	TR-10FF	271
431492	TR-11GG	271
460086	TR-12HH	271
460100	TR-15	272
429337	TR-2	271
429338	TR-3	271
502152	TR-4	271
429340	TR-5	271
457770	TR-6B	271
431489	TR-6BB	271
431493	TR-6BBB	271
457771	TR-6BBBB	271
431494	TR-7CCC	271

Item #	Mfg. #	Page #
457780	TR-8D	271
451539	TR-8DD	271
431495	TR-8DDD	271
459237	TR-8DDDD	271
457781	TR-9E	271
460083	TR-A	272
460084	TR-B	272
457786	TR-D	272
460098	TR-G	272
513903	WR-1020	133

UPDATE INTERNATIONAL

476451	ABNP-100	235
476452	ABNP-50	235
476301	ABO-3X3	151
482269	ACO-16	219
476308	AD-12	227
476309	AD-16	227
476310	AD-20	227
476312	AIS-100	130
476313	AIS-190	130
477338	APB-1424FD	117
482271	APB-2112FD	117
477339	APB-2117	117
476314	APM-06	252
476315	APM-07	252
476316	APM-08	252
476317	APM-10	252
476318	APM-12	252
497116	APRK-3	131
482278	BC-3	86
481458	BC-3520G	278
482279	BC-5	86
482290	BO-7F	150
482458	BS-9	152
482291	BSP-11	152
482292	BST-4	152
482293	CB-1520	197
482294	CC-FH	111
482295	CD-5	149
476319	CD-8890	129
476320	CD-8890/OR	129
482296	CO-7G	247
484791	CR-1725	250
482297	CTS-26	152
476283	CUB-10C	235
476282	CUB-10S	235
476321	DOM/CP-11	107
476323	DOM/CP-12	107
476335	DOM/CP-15	107
476337	DOM/CP-18	107
481083	DP-10	227
481081	DP-16	227
476338	DP-SP	227
482343	DR-10	243
476195	DSS-12/BK	129
476340	DT-3545	132
476341	DT-6X6	132
482345	EGU-5	217
482349	EP-33	130
476342	ES-AL	217
484615	ESC-10	131
476343	FB-126PH	235
476345	FB-135PH	235
482353	FFT-1216BK	143
482354	FFT-1216RD	143
476346	FLT-CYP	276
476347	FPW-5	243
476349	FSV-6S	155
482356	GR-3T	149
482357	GR-449	215
482358	GT-1400BK	143
482359	GTFG-2700BK	143
476197	H422/20	130
476198	H422/32	130
476201	H422/64	130

MANUFACTURER NUMERICAL INDEX

Item #	Mfg. #	Page #	Item #	Mfg. #	Page #	Item #	Mfg. #	Page #
476350	HB-1/PH	115	476293	PT-WR14	257	476433	UP-13	153
476351	HB-10/PH	115	476294	PT-WR15	257	482442	UP-72	245
476356	HB-11/PH	115	476284	PT-WR16	257	476434	WC-AC	153
476357	HB-2/PH	115	476285	PT-WR17	257	476435	WCS-KD	111
476360	HB-5/PH	115	476286	PT-WR9	257	482460	WDS-36	220
476361	HB-7/PH	115	476408	PTN4/1-100	146	476436	WM/CP-31	107
485831	HF-2020	283	481089	PTR-15	259	476437	WM/CP-32	107
535459	IC-1800W	113	476410	PTS-9	259	476439	WM/CP-34	107
476362	IG-1624	250	482384	PW-12	223	476442	WM/CP-35	107
482361	IS-40	239	482385	PW-16	223	476443	WM/CP-36	107
482362	IS-70	239	481090	RD-5	260	476444	WM/CP-38	107
482363	ISC-40	239	495829	RE-101	107	482443	WP-32SC	63
482364	ISC-70	239	497115	RE-103	107	482444	WP-60PC	63
482365	ISHC-70	239	501030	RE-104	107	476445	WPF-13	220
482366	J1-1	152	495830	RE-105	107	476446	WPF-21	220
476363	J1-2	152	501129	RE-107	107	476447	WPS-6	261
476365	J1-3	152	495831	RE-108	107	484784	WSER-7	217
476366	J1-5	152	501130	RE-111	107	476448	WSP-14	223
484792	KR-1212	199	501131	RE-112	107	476449	WSP-18	223
476367	KW-48	223	476413	RPA-3518	249	482445	WTPF-10	218
482367	LOP-10	224	476414	RPW-3215	249	484780	WTSD-48	219
482368	LOP-20	224	476415	RPW-3218	249			
482369	LOP-30	224	482386	RSC-16	220			
482370	LOP-40	224	476204	SA-19X	130			
482371	LOP-60	224	483638	SBC-12	253			
476368	LSVL-25/BK/BT	131	482388	SBC-16W	253			
482372	MB-1300	241	482387	SBR-12	253			
482373	MB-150	241	482390	SBY-12	253			
482374	MB-300	241	476416	SC-25	137			
482377	MB-500	241	481408	SCC-19	111			
482379	MB-800	241	482392	SCP-12C	244			
484781	MC-30	152	482393	SCP-24C	244			
476371	MCH-18	146	476417	SH/CP-501	107			
476372	MEA-CUP	242	476418	SH/CP-502	107			
482380	MEA-SPDX	242	476419	SH/CP-503	107			
482381	MJHD-21N	156	476421	SH/CP-505	107			
476373	MPA-12	251	476423	SH/CP-507	107			
476374	MPA-24	251	476424	SH/CP-508	107			
476375	MPS-36	223	481091	SHD-12/SS	219			
476376	MPS-48	223	476426	SK-RPF	136			
484782	MPW-36	223	482397	SPH-1002	239			
484783	MPW-48	223	482398	SPH-1004	239			
476377	MT-AL	216	482399	SPH-1006	239			
476378	ND-7	141	482400	SPH-114	239			
482382	PBA-10	148	482401	SPH-164	239			
476385	PC-4	261	482402	SPH-166	239			
476386	PC-4WH	261	482459	SPH-254	239			
486744	PCD-13	254	482403	SPH-332	239			
481088	PCD-13/SS	254	482404	SPH-334	239			
476388	PCD-STD	254	482405	SPH-336	239			
482383	PCT-9BK	223	482406	SPH-502	239			
476389	PG-1018	239	482407	SPH-504	239			
476390	PG-510	239	482408	SPH-506	239			
476391	PG-810	239	476427	SPT-6	222			
476392	PGRIP(D)	259	476428	SSK-55	219			
476393	PGRIP(S)	259	501291	SSP-50	281			
483909	PIB-20	262	482143	ST-12HD/CS	223			
476394	PMRD-24	217	482144	ST-9HD/CS	223			
476395	PMSQ-18	217	482409	STP-100CHC	239			
476397	PR-6BC	217	482410	STP-16CHC	239			
476398	PR-6C	217	482411	STP-33CHC	239			
476400	PS-08	258	482413	STP-50CHC	239			
476295	PS-09	258	481092	STP-RC	239			
476401	PS-10	258	476429	STPF-14	219			
476296	PS-11	258	476205	SV-100	130			
476297	PS-12	258	482430	SV-70	130			
476402	PS-13	258	476431	TB-35	146			
476298	PS-14	258	482432	THCF-20D	188			
476299	PS-15	258	482433	THFR-17	187			
476300	PS-16	258	482436	THOV-20	187			
476403	PS-17	258	482437	THP-550	188			
476404	PS-18	258	482438	THRE-20	187			
476405	PSA-10	218	476432	TK-85	138			
476202	PSVL-25/BK/BT	131	482440	TOPP-12	223			
476290	PT-WR11	257	482441	TSC-37	144			
476291	PT-WR12	257	485038	UD1000N	130			
476292	PT-WR13	257	479100	UD1000P	130			

VERTEX

534553	ARG-1	84
534563	ARG-11	84
534583	ARG-12	84
534585	ARG-13	84
534580	ARG-16	84
534556	ARG-2	84
534582	ARG-21	84
534573	ARG-5	84
534574	ARG-6	84
534575	ARG-7	84
534577	ARG-8	84
534578	ARG-9	84
534605	AST-3-P	84
534568	CAT-10	84
534566	CAT-11	84
534588	CAT-12	84
534590	CAT-13	84
534591	CAT-14	84
534600	CAT-16	84
534571	CAT-18	84
534570	CAT-24	84
534561	CAT-4	84
534593	CAT-5	84
534595	CAT-6	84
534596	CAT-7	84
534598	CAT-8	84
534603	CRE-3-PR	86
534551	CRE-6-V	86
534509	CRV-1	83
534515	CRV-10	83
534513	CRV-11	83
534517	CRV-12	83
534518	CRV-13	83
534519	CRV-14	83
534516	CRV-15	83
534525	CRV-16	83
534510	CRV-17	83
534511	CRV-2	83
534512	CRV-4	83
534520	CRV-5	83
534521	CRV-6	83
534522	CRV-7	83
534523	CRV-8	83
534524	CRV-9	83
534607	CSC-1	83
534615	CSC-11	83
534622	CSC-12	83
534623	CSC-13	83
534621	CSC-16	83
534609	CSC-2	83
534612	CSC-4	83
534616	CSC-6	83
534617	CSC-7	83
534619	CSC-8	83

MANUFACTURER NUMERICAL INDEX

Item #	Mfg. #	Page #	Item #	Mfg. #	Page #	Item #	Mfg. #	Page #
530827*	40743	175	432396	47091	224	429551	58126	221
530829*	40744	175	432397	47092	224	381766	58322	224
530830*	40756	164	432398	47093	224	381767	58344	224
530832	40757	164	432399	47094	224	381768	58355	224
530807	40760	164	432400	47097	224	379801	61155	226
530814*	40790	172	379722	47106	222	379804	61157	226
530816*	40791	172	379724	47109	222	400246	61165	226
530818*	40793	172	379727	47110	222	400244	61167	226
530821*	40794	172	379726	47112	222	379809	61170	226
530822*	40799	175	379730	47113	222	379811	61172	226
530828*	40800	175	379732	47116	222	379814	61175	226
525104	40803	175	379734	47139	227	379815	61177	226
530831	40804	175	379738	47140	227	379816	61180	226
534897	40813	174	379740	47141	227	493180	61182	226
534899	40815	174	379741	47142	227	379819	62170	226
530833	40819	176	379742	47143	227	379822	62172	226
537552	40830	176	379744	47144	227	379824	62175	226
530823	40837	173	379745	47145	227	379826	62177	226
530817	40839	172	379747	47146	227	452046	64130	226
530839	40848	169	379748	47147	227	457846	64132	226
530834*	40849	175	453510	47159	227	450797	64134	226
530842	40850	174	453509	47161	227	452308	64136	226
534895	40858	174	379749	47309	222	457843	64138	226
399876	45682	213	379751	47312	222	457891	64403	225
368212	46003	86	379752	47316	222	457892	64404	225
368249	46005	86	380441	47406	137	457893	64405	225
428894	46050	110	380437	47422	137	457877	64406	225
432000	46060	111	380432	47428	137	457878	64407	225
379651	46205	86	425216	47488	237	458691	64408	225
371033	46210	131	425217	47490	236	379530	67020	231
371129	46212	131	379753	47573	137	445345	67228	232
371007	46310	85	379756	47575	137	457389	67312	231
428885	46320	110	379757	47578	137	537551	67315	231
458968	46569	119	487202	47700	216	379525	67409	231
380361	46570	129	405999	47713	213	537540	67411	231
446063	46590	119	379759	47932	242	485445	67509	231, 232
431510	46609	154	379761	47933	242	368325	67512	232
367965	46713	137	379762	47934	242	371054	67520	232
435272	46776	137	379764	47935	242	415384	67521	232
379655	46811	224	379768	47938	242	371030	67524	232
379656	46812	224	379769	47943	242	370984	67540	232
379657	46814	224	379771	47946	242	428257	67541	232
379658	46816	224	371107	48013	137	379827	67607	229
379659	46818	224	379773	48015	137	393091	67608	229
381759	46864	111	368243	48104	115	379833	67610	229
535294	46892	244	367991	48140	109	371052	67614	229
534708	46893	244	395460	48143	109	379835	67711	230
528757	46894	244	431497	49520	110	379838	68127	234
379664	46901	224	480714	49522	110	368044	71001	167
379666	46902	224	453137	49529	110	394573	72000	167
381691	46903	224	424429	51008	252	371120	72017	166
379667	46904	224	398070	51016	251	371055	72021	166
379668	46906	224	397638	51045	252	379840	72165	166
379669	46908	224	429528	52009	221	379845	75012	238
379671	46912	224	429543	52010	221	379849	75020	238
460082	46915	224	429530	52013	221	379851	75120	238
379672	46935	114	429536	52016	221	379853	75130	238
379673	46936	114	393099	52023	221	379857	75140	238
452049	46945	226	429544	52026	221	379859	75160	238
452050	46946	226	368251	52063	253	442303	75210	238
379674	46952	114	429539	52109	221	379865	75220	238
379678	46960	114	393095	52113	221	379867	75230	238
379679	46961	226	429541	52116	221	379869	75240	238
379680	46962	226	412496	52290	273	379873	75260	238
379681	46963	226	370863*	52293	273	368235	77200	238
437509	46970	219	379781	52641	273	379875	77250	238
379687	46973	226	393060	52643	276	368315	77400	238
379689	46975	226	368263	52644	276	379876	78150	237
379690	46976	226	370677	56507	229	379880	78154	237
379698	46981	226	381762	58011	224	387861	78160	237
379700	46983	226	379783	58022	224	379883	78164	237
379702	46985	226	381763	58033	224	379885	78180	237
432401	47002	224	379789	58044	224	379886	78184	237
432402	47003	224	381764	58055	224	379890	78200	237
432403	47004	224	381765	58066	224	379892	78204	237
432404	47005	224	429545	58110	221	380484	81180	138
432405	47006	224	429548	58123	221	380493	81190	138

MANUFACTURER NUMERICAL INDEX

Item #	Mfg. #	Page #	Item #	Mfg. #	Page #	Item #	Mfg. #	Page #
432415	90022	237	457899	6412335	225	437424	1112	106
432416	90023	237	457852	6412445	225	437426	1145	106
432418	90042	237	457856	6412655	225	437427	2801	105
432417	90043	237	457858	6412865	225	437429	2805	105
432419	90062	237	457847	6422230	225	437433	2812	105
432423	90222	237	457898	6422335	225	437435	2845	105
432424	90242	237	457851	6422445	225	437436	2901	104
432425	90243	237	457855	6422655	225	437438	2905	104
432439	90262	237	457857	6422865	225	437440	2907	104
432442	90322	237	370878	0644N	211	437453	2945	104
432443	90342	237	378480	1102R	282	437470	5101	106
432446	90362	237	460070	3908C	230	437473	5105	106
432449	90422	237	460071	3910C	230	437475	5106	106
432450	90442	237	460072	3911C	230	437476	5112	106
432454	90462	237	460074	3914C	230	437477	5145	106
432457	90622	237	378472	501N	214	437462	5501	104
432458	90642	237	376679	606N	212	437463	5505	104
432459	90662	237	515251	67412	231	437465	5507	104
432462	90942	237	537541	67413	231	437466	5512	104
525890	92070	146	537546	67417	231	437469	5545	104
432421	93100	237	537549	67418	231	437696	6601	105
432440	93200	237	537543	67424	231	437698	6605	105
432447	93300	237	415384	67521	231	437708	6612	105
432455	93400	237	535725	67533	231	437710	6645	105
432460	93600	237	428257	67541	231	437543	7201	106
432422	94100	237	448589	67561	231	437546	7204	106
432441	94200	237	402332	67581	231	437547	7205	106
432448	94300	237	445365	67691	231	437552	7206	106
432456	94400	237	535290	68183	243	437545	7207	106
432461	94600	237	535300	68184	243	437544	7212	106
379897	97111	278	472042	68224	232	437553	7224	106
376035	97112	278	535296	68296	242	437554	7401	106
370902	97120	277	530521	68298	219	437570	7404	106
370914	99765	237	368176	68350	219	437571	7405	106
368294	99785	237	524593	68351	242	437572	7406	106
367932	99850	110	527754	68352	242	437556	7407	106
444237	99860	110	535297	68357	236	437555	7412	106
396959	379008	212	535288	68361	236	437573	7443	106
432964	379009	212	538142	68362	236	437474	51054	106
370895	430712	232	535301	68369	236	437699	66051	105
379506	434112	231	449418	68391	236	437746	74149	114
379508	434212	231	537529	7341C	230	437748	74151	114
379510	434312	231	537531	7342C	230	437492	620527	108
379511	434412	231	537532	7344C	230	437494	660527	108
379513	434512	231	537535	7345C	230	437497	750527	108
379515	434812	231	537536	7347C	230	437498	760527	108
379571	448212	236	537537	7348C	230	437500	780527	108
368875	566445	229	537538	7350C	230	437501	790527	108
457894	4780910	222	537539	7351C	230	437756	0-U16	114
457897	4780911	223	388609	77110	231	437757	0-U18	114
460956	4780920	223	378485	9002P	235, 252	536045	801801	105
457895	4781210	222	413971	BCO-1	247	536047	801805	105
457896	4781610	222	387710	BCO-11	247	536049	801806	105
482548	4781620	223	535540	E4010	228	536054	801815	105
457880	4980010	225	535541	E4012	228	536056	801845	105
458183	4980110	225	535542	E4014	228	536057	802101	105
457859	4980120	225	497875	ES4008	228	536065	802105	105
457883	4980210	225	429166	N7007	228	536067	802106	105
457863	4980230	225	429170	N7008	228	536072	802115	105
457884	4980310	225	429171	N7010	228	536073	802145	105
457865	4980335	225	429172	N7012	228	437502	840529R	108
457885	4980410	225	429178	N7014	228	437454	PAC01	104
457867	4980445	225	379495	S4007	228	439790	PAC05	104
457887	4980610	225	379497	S4008	228	437675	PAC051	104
457868	4980655	225	535550	S4010	228	437455	PAC06	104
457869	4980865	225	535551	S4012	228	437456	PAC07	104
379898	5267010	273	535552	S4014	228	437457	PAC11	104
379902	5267110	273	379500	Z4007	228	437458	PAC12	104
379905	5267210	273	379502	Z4008	228	437460	PAC45	104
379908	5267410	273	535553	Z4010	228	437461	PAC451	104
379910	5267510	273	535554	Z4012	228	437732	UL-011	115
379912	5267611	273	535555	Z4014	228	437733	UL-012	115
379913	5267711	273				437734	UL-014	115
379966	5269510	273				437735	UL-015	115
379967	5271211	273				437739	UL-022	115
379968	5271511	273				437740	UL-027	115
457848	6412230	225				437742	UL-029	115
			437419	1101	106			
			437421	1105	106			
			437423	1107	106			

WALCO STAINLESS INC.

MANUFACTURER NUMERICAL INDEX

Item #	Mfg. #	Page #
437736	UL-125	115
437737	UL-126	115
437743	UL-7223	115
437744	UL-7225	115
437745	UL-7253	115
437505	WLB01	115
437506	WLB02	115
437507	WLB04	115
437729	WLB06	115

WARING

379413	6001C	156
379317	BB150	159
379320	BB150S	159
416580	BB180	159
484327	BB180S	159
383503	CAC21	159
414981	CB15	161
487374	CTS1000	168
379343	DMC20	157
434438	FP25C	163
379355	HGB150	161
395001*	JC4000	156
519631	MX1000XT	159
537851*	MX1000XTX	159
381409	WCG75	163
483645	WCO500	176
381410	WCT704	168
416578	WCT708-1	168
431458	WCT800	168
483640	WCT820	168
459658	WDF75RC	174
536252	WFP11S	162
484525	WFP14	163
537850	WFP14SC	162
459663*	WJX50	156
459654	WKS800	198
459659	WPG250	172
483643	WSB2W	162
432478	WSB33	162
460725	WSB40-3	162
431457	WSB60-3	162
473402	WSB70-3	162
483641	WSM7Q	163
448271	WW150	167
537849	WW200	167

WIN HOLT

483101	ADE1820B/KDA	178
501132	AL-1820B	177
510096	CR-162	178
486002	CR-162M	178
483241	DASQ-3-1220	180
483242	DASQ-4-1220	180
493204	NHPL-1836-ECO	178
483102	SRC-58/3Z	178
483095	SSWMS124/KD	180
483107	SSWMS125/KD	180
502495	WHPL-8GY	177, 277
483096	WSHS-1410-5-F	275

WINCO

504813	AAD-12	217
504814	AFP-10A	229
504815	AFP-10NS-H	229
504817	AFP-10XC-H	229
504818	AFP-12A	229
504819	AFP-12NS-H	229
504820	AFP-12XC-H	229
504821	AFP-14A	229
504822	AFP-14NS-H	229
504824	AFP-14XC-H	229
504825	AFP-8A	229
504827	AFP-8NS-H	229
504828	AFP-8XC-H	229
504957	ALB-15	233

504962	ALB-18	233
504964	ALB-24	233
504829	ALPC-100	233
504830	ALPC-20	233
504831	ALPC-24	233
504832	ALPC-32	233
504833	ALPC-40	233
504835	ALPC-50	233
504838	ALPC-60	233
504839	ALPC-80	233
505001	ALRK-20	178
504965	ALST-100	233
504966	ALST-20	233
504967	ALST-24	233
504968	ALST-32	233
504969	ALST-40	233
504970	ALST-50	233
504972	ALST-60	233
504973	ALST-80	233
504975	ALXP-1013	235, 252
507097	ALXP-1318	235, 252
504980	ALXP-1826	235, 252
504982	ALXP-2618H	235, 252
504984	APS-20	234
504840	ASP-1	233
504841	ASP-10	233
504842	ASP-10C	233
504843	ASP-1C	233
504844	ASP-2	233
504845	ASP-2C	233
504846	ASP-3	233
504847	ASP-3C	233
504848	ASP-4	233
506273	ASP-4C	233
504850	ASP-5	233
504851	ASP-5C	233
504985	ASSP-08	233
504854	ASSP-08C	233
504986	ASSP-14	233
504856	ASSP-14C	233
504987	ASSP-20	233
504857	ASSP-20C	233
504988	C-3080B	111
504990	C-6080	111
516749	CGS-38K	147
504991	CHH-101	145
504992	CHH-103	145
504993	CHH-104	145
504859	GP-1	215
507484	KC-301	210
504860	LC-01	137
504861	LC-03	137
504863	LED-10	147
504864	LED-11	147
504865	MDL-15	215
509289	MH-2	146
504866	OM-13	220
538938	PL-3	262
538939	PL-36C	262
505004	PMC-14K	146
505005	PMC-5K	146
505006	PMC-9K	146
505008	PMC-9U	146
505009	PMCD-9K	146
505010	PMCD-9U	146
505011	PMCT-9K	146
504880	PR-16	217
504891	PSG-10	220
504892	PSG-14	220
504893	PSG-16	220
504894	PSH-10	220
504895	PSH-14	220
504896	PSH-16	220
538169	RC-P300	177
538168	RC-S300	177
504961	RSB-6	272
504898	RSK-10	229

504899	RSK-12	229
504900	RSK-6	229
504902	SIZ-11	138
504903	SP7100C	241
504904	SP7102	241
504906	SP7104	241
504907	SP7106	241
504908	SP7200C	241
504909	SP7202	241
504910	SP7204	241
504911	SP7206	241
504912	SP7300C	241
504913	SP7302	241
504914	SP7304	241
504915	SP7306	241
504916	SP7400C	241
504917	SP7404	241
504919	SP7406	241
504920	SP7600C	241
504921	SP7602	241
504923	SP7604	241
504924	SP7606	241
504926	SP7900C	241
504928	SP7902	241
504929	SP7904	241
504930	SSFP-11NS	229
504932	SSFP-8NS	229
504933	SSFP-9	229
504934	SSFP-9NS	229
504936	SSSP-2	233
504938	SSSP-3	233
504939	SSSP-4	233
504940	SST-12	234
504941	SST-16	234
504942	SST-20	234
504943	SST-24	234
504944	SST-8	234
504945	SVM-8	219
504946	SWA-2	220
504947	SWA-9	220
504948	SWU-11	138
504997	TR-33W	145
504998	TR-34W	145
504949	TSY-1A	145
504999	UC-35G	277
505000	UC-35K	277
504950	WB-29S	154
504951	WB-4HV	154
504953	WC-5	154
504954	WPB-2C	137
504955	WPB-3C	137
504956	WPC-60	63
504958	WPCT-60C	63

WORLD TABLEWARE BY LIBBEY

531093	127-001	101
531092	127-002	101
531094	127-016	101
531095	127-021	101
531154	127-029	101
531139	127-030	101
531148	127-038	101
531122	127-7922	101
534442	129-001	103
534450	129-030	103
534445	129-7922	103
531161	130-001	102
531162	130-002	102
531164	130-003	102
534438	130-016	102
531165	130-021	102
531156	130-029	102
531140	130-030	102
531150	130-038	102
531277	130-5262	102

MANUFACTURER NUMERICAL INDEX

Item #	Mfg. #	Page #	Item #	Mfg. #	Page #	Item #	Mfg. #	Page #
531123	132-001	102	528056	657-038	103	413902	OAG-15-WW	88
531125	132-002	102	528057	657-5302	103	522394	OAG-8-WWW	88
531127	132-016	102	397596	840-110-004	73	397689	OSC-12	89
531129	132-021	102	397597	840-116-101	73	397691	OSC-15-H	89
531135	132-029	102	397599	840-125-002	73	397692	OSC-15H	89
531144	132-030	102	397600	840-215-005	73	397693	PWC-1	74
531145	132-0304	102	397602	840-310-020	73	397695	PWC-10	74
531158	132-038	102	397603	840-320-020	73	397697	PWC-11	74
531133	132-5262	102	397605	840-340-008	73	397698	PWC-12	74
531297	134-001	101	397606	840-345-007	73	397699	PWC-13	74
531288	134-002	101	397607	840-350-035	73	397700	PWC-14	74
531284	134-016	101	397608	840-360-009	73	397990	PWC-15	74
531141	134-030	101	397609	840-370-200	73	397701	PWC-16	74
531151	134-038	101	397610	840-405N-10	71	397702	PWC-18	74
531280	134-5262	101	397612*	840-405R-22	73	413835*	PWC-19	74
466579	135-001	101	397614	840-410N-11	71	397704	PWC-2	74
466580	135-016	101	397615	840-410R-23	73	397705	PWC-24	74
466581	135-021	101	397617	840-420N-12	71	397706	PWC-3	74
466582	135-030	101	397618	840-420R-24	73	397708	PWC-31	74
466583	135-5262	101	397621	840-425N-13	71	397709	PWC-32	74
398290	136-001	100	397622	840-425R-25	73	397710	PWC-34	74
531087	136-002	100	397623	840-430N-14	71	399817	PWC-39	74
531088	136-016	100	435274*	840-438R-10	73	397712	PWC-4	74
531089	136-021	100	397624	840-440N-15	71	487860*	PWC-40	74
531137	136-030	100	401566	840-445-R12	73	420900*	PWC-45	74
531147	136-038	100	397647	840-520N-17	71	399280	PWC-5	74
531090	136-5262	100	469908*	840-520N-9	71	410330	PWC-50	74
531299	138-001	102	522488*	840-520R-15	73	397714	PWC-6	74
531290	138-002	102	397649	840-520R-24	73	464487	PWC-60	74
531286	138-016	102	440321	840-530R-30	73	397729	PWC-7	74
531292	138-021	102	490558	CA-75	85	397731	PWC-8	74
531142	138-030	102	481625	CB-004	89	397733	PWC-9	74
531134	138-038	102	478916	CB-080	89	399751	RM-P-CP	85
534440	138-5262	102	492644	CM-12	85	399753	RM-P-WP	85
464430	141-001	103	397653	DSD-1	71	399753	RM-P-WP	85
464431	141-016	103	397654	DSD-10	71	464301	SL-10	72
507694	141-021	103	397655	DSD-11	71	467204*	SL-11	72
464432	141-030	103	397656	DSD-12	71	464298	SL-14	72
464433	141-5262	103	397657	DSD-13	71	464296	SL-20	72
489622	145-001	101	397658	DSD-14	71	464297	SL-21	72
489623	145-016	101	398954	DSD-15	71	461227	SL-22	72
489617	145-021	101	397659	DSD-16	71	482579	SL-23	72
489618	145-029	101	397660	DSD-17	71	488358	SL-40	72
489619	145-030	101	397661	DSD-2	71	464295	SL-6	72
489620	145-038	101	397662	DSD-4	71	469909	SL-7	72
489621	145-5262	101	397664	DSD-6	71	464293	SL-9	72
531294	148-001	103	397665	DSD-7	71	498940	SPH-716-W	87
534447	148-016	103	397666	DSD-8	71	397776	TM-8-W	85
531160	148-030	103	397668	DSD-9	71	397777	VIC-11	72
531159	148-038	103	457507	END-10	73	397778	VIC-13	72
531272	148-5262	103	457513	END-15	73	401735	VIC-14	72
531086	165-001	102	457520	END-18	73	397779	VIC-16	72
506520	165-016	102	457505	END-20	73	397783	VIC-3	72
502632	165-030	102	474976*	END-22	73	397789	VIC-38	72
470474	165-5262	102	457504	END-24	73	397791	VIC-4	72
531274	200-1492	109	457416*	END-26	73	398564	VIC-6	72
534698	200-1692	109	473717	END-3	73	400973	VIC-7	72
531282	200-1702	109	457514	END-4	73	397792	VIC-8	72
531276	201-2492	109	457510	END-6	73	400974	VIC-9	72
534699	201-2542	109	457509	END-7	73	397793	WEL-1	75
531267	201-2632	109	457519	END-9	73	397713	WEL-10	75
534700	201-2702	109	457537	ES-1000	111	397716	WEL-11	75
526749	651-001	103	520803	HS-12	89	397718	WEL-16	75
528036	651-002	103	487976	HS-18	89	397719	WEL-2	75
534431	651-003	103	397669	NR-1	74	400018*	WEL-3	75
528037	651-007	103	397671	NR-11	74	397720	WEL-4	75
528038	651-016	103	397672	NR-12	74	397721	WEL-5	75
528039	651-029	103	397673	NR-13	74	397722	WEL-6	75
528040	651-030	103	397674	NR-14	74	397724	WEL-7	75
534432	651-038	103	397675	NR-16	74	397725	WEL-8	75
535406	651-5302	103	397676	NR-2	74			
528050	657-001	103	397679	NR-5	74			
528051	657-002	103	397680	NR-6	74			
528052	657-016	103	397681	NR-7	74			
528053	657-021	103	397682	NR-8	74			
528054	657-029	103	398903	NR-9	74			
528055	657-030	103	397685	OAG-12-WW	88			

HACCP TIPS

HACCP Food Safety	181-182
Storing Refrigerated Food	196

BUYER'S GUIDE

Suggested Requirements For a 100 Seat Restaurant	348-351
---	---------

GENERAL TIPS

Abbreviations Common to the Foodservice Industry	177
Basic Knives & Their Uses	207
Buying Shelving	180
Care of Fryer Oil	174
Commercial Kitchen Lighting	301
Contents of Standard Cans	247
Cooler Temperature Guide	347
Cutlery Care	202
Flatware Corrosion, Tarnishing & Buildup	109
Food Equipment Tips	214
Glass Jars: How They Do & Don't Stack Up	136
Glassware Coding	52
Glassware Equivalency Chart	53-59
Guide to Steam Table Pans	237, 346
Kitchen Smallwares Guide for 100	222
Napkin Folding	125
Opal Dinnerware	80
Pizza Pans	258
Plastic Cleaning	121
Portion Control	244
Suggested China Care	75
Suggested Flatware Service for 100 People	109
Tabletop Lighting	125
Textile Tips	267
Use & Care of Aluminum	232
Wok Cooking	256

A

Adaptor Bar	238
Adaptor Plate	167, 237
Air Freshener & Dispenser	298
Airpot	131
Airpot Rack	131
Apparel	265-269
Apple Corer	215
Apple Divider	217
Appliance Cleaner	283
Apron	
Bib Apron	265, 267, 269
Bistro Apron	265
Dishwashing Apron	269
Four-Way Apron	265
Waist Apron	265, 267
Wet Area Apron	267, 269
Ashtray	31, 41, 50, 154
Au Gratin Dish	88, 137

B

Baby Changing Station	301
Baffle Filter	282
Bag, Shopping	307
Bagel Cutter	215
Bagel Toaster	168
Bake Pan	236
Bake Pan Liner	304

Baker/Casserole Dish	88
Baker's Rack	177, 178
Baker's Spatula	201, 204, 206
Bakery Supplies	248-252
Baking Mat	235, 252
Bamboo Steamer	256
Banana Split Dish	30
Bandage	193
Bar Blender	158-160
Bar Caddy/Organizer	150
Bar Juicer	123, 156
Bar Liner	148
Bar Mat	148, 284
Bar Mix Container/Dispenser	148
Bar Mop Towel	268
Bar Shaker	61, 152
Bar Sink Drain	155
Bar Spoon	152
Bar Strainer	152
Bar Supplies	61, 148-156, 268
Bar Towel	268
Bar Tray	143
Bar, Food	123
Barrier, Post & Belt	147
Basket	139, 140
Basket Liner	304
Basting Brush	248
Basting Cover, Grill	234
Basting Mop	248
Basting Spoon	226
Bath Tissue Dispenser	298, 299
Bathroom Cleaner	309, 310
Batter Dispenser	254, 255
Batter Dispenser Stand	254
Battery, Copper Top	303
Bean Masher	217
Beer Glass Cleaner	155
Beer Glass Sanitizer	155
Beer Mug	26, 27, 35, 36
Beer Sample Paddle/Holder	36
Beer Tap Plug	150
Bell, Table	146
Bench Brush	249
Beverage Carrier/Dispenser	122, 132
Beverage Dispenser	127, 128, 132
Beverage Server	129-131
Beverage Service Mat	148
Birthday Candle	125
Biscuit Cutter	249
Blender	
Bar Blender	158-160
Food Blender	157-161
Hand Blender	162
Blender Parts & Containers	158-160
Blender Repair Kit	158
Blood Clean-Up Kit	300
Bomb Cup	151
Booster Seat	145
Bottle Brush	279
Bottle Cap Catcher	150
Bottle Holder	150
Bottle Opener	150
Bottle Rack	150
Bouillon Strainer	218
Bowl	
Beehive Buffet Bowl	119

Buffet Bowl	91, 116, 119	Heater Proofer Cabinet	178
Glass Bowl	51	Pan Carrier Cabinet	123
Mixing Bowl	241, 242	Cake Pan	250, 251
Punch Bowl	116	Cake/Pie Cover	117
Salad Bowl	51, 91, 116, 119	Cake Ring	250
Soup Bowl, Onion	89	Cake Server	115, 201, 207
Box Cutter	295	Cake Stand	117
Brazier	232	Camcarrier®	122
Bread Basket	139	Camcart®	123
Bread Board	138	Can Liner	307
Broiler Brush	279	Can Opener	215, 246, 247
Broom	293	Can Opener Part	246, 247
Broom Handle	294	Can Punch	247
Brush – Cleaning		Can Rack	178
Broiler Brush	279	Candle	125, 126
Carafe Bottle Brush	279	Cap Catcher	150
Coffee Brush	279	Carafe	
Coffee Maker Brush	279	Beverage/Juice Carafe	62, 63
Cutting Board Brush	197, 279	Coffee Carafe	129, 130
Decanter Brush	279	Wine Carafe	31, 41, 62, 63
Deck Brush	294	Carafe Bottle Brush	279
Fryer Brush	279	Cart	
Glass Washer Brush	155	Bus Cart	277, 278
Grout Brush	295	Pan Carrier Cart, Heated	123
Grill Brush	279	Utility Cart	277, 278
Pizza Oven Brush	279	Cart Silverware Bin	278
Toilet Bowl Brush	296	Cart Trash Container	278
Urn Brush	279	Carving Station	114, 165
Wok Brush	256	Cash Register Roll	303
Brush – Cooking		Casserole Dish	87, 89
Basting Brush	248	Catering Carrier Chiller	122
Bench/Flour Brush	249	Catering Pan Carrier	122, 123
Flour Brush	249	Caution Sign	292
Pastry Brush	248	Chafer	110, 111, 302
Potato Brush	248	Chafer Fuel Holder	111
Vegetable Brush	248	Chafer Heater	111
Brush Handle	294	Chafer Pop-up Set	111
Bucket		Chafer Set	111, 302
Cleaning Bucket	295	Chafer Wire Stand	111
Mop Bucket/Wringer	291	Chafing Fuel	112, 302
Wine Bucket	153, 154	Champagne Bucket & Stand	154
Buffet Serving Piece		Char-Broiler	173
Buffet Bowl	91, 92, 116, 119	Charcoal Lava Rock	173
Buffet Tray	91, 92, 116	Check Holder	145, 146
Buffetware	114, 115	Check Rack	146
Buffet Stove/Range	113	Check, Guest	303
Bulb Warmer	165	Cheese Cutter	216
Bun Pan	235, 252	Cheese Grater	136
Bun Pan Grate	250	Cheese Plane	215
Bun Pan Liner	304	Cheese Shaker	136
Bun Pan Rack	177	Cheese Warmer/Melter	170
Burn Care Kit	193	Cheesecloth	269
Burner w/Stand	113	Cheesemelter Oven	169
Bus Box	276, 277	Chef's Clothing	
Bus Cart	277, 278	Apron	265, 267, 269
Butane Fuel	113	Chef's Coat	266
Butane Lighter	113, 126	Chef's Hat	268
Butane Stove	113	Chef's Pants	266
Butane Torch	113	Cook's Shirt	266
Butcher's String	249	Kitchen Cap	268
Butcher's Steel	201, 203, 209, 210	Chef's Torch	113
Butter Melter/Warmer	137, 170	Chemical	
Butter Spreader	217	Appliance Cleaner	283
C		Cleaner & Polish, S/S, Metal	308
Cabinet		Coffee Brewer Cleaning Tablet	128
Holding Cabinet	123	Degreaser	308

Dishwashing.....	310	Windsor.....	82
Disinfectant.....	309	China Cap Strainer.....	218
Floor Cleaner.....	310	Chopper.....	163, 213
Fryer Cleaner.....	308	Clam Knife.....	202
Furniture Polish.....	310	Cleaning Chemical.....	See Chemical
Glass Cleaner.....	309	Clean-up Kit, Blood Pathogen.....	300
Griddle Cleaner.....	283	Cleaver.....	206, 210, 256
Grill Cleaner.....	308	Clothing	
Insecticide.....	310	Apron.....	265, 267, 269
Metal Cleaner/Polish.....	308	Chef's Coat.....	266
Oven Cleaner.....	308, 309	Chef's Hat.....	268
Pan Detergent.....	310	Chef's Pants.....	266
Pot Detergent.....	310	Cook's Shirt.....	266
Toilet Bowl Cleaner.....	310	Kitchen Cap.....	268
Urinal Descaler.....	297	Cocktail Decanter.....	31
Urinal Toss Block.....	297	Cocktail Shaker.....	152
Chemical Container Pump.....	300	Coffee Brewer.....	128
Chemical Scoop.....	300	Coffee Brewer Cleaning Tablet.....	128
Chilling Paddle.....	190	Coffee Brewer Funnel.....	128
China		Coffee Decanter Brush.....	279
Appetizer.....	78	Coffee Decanter/Carafe.....	129, 130
Arcadia.....	65	Coffee Maker Brush.....	279
Argyle.....	84	Coffee Mug.....	28, 40, 85
Atlantic™.....	68	Coffee Server.....	130, 131
Cafe Royal®.....	75	Coffee Stirrer.....	305
California Scalloped.....	83	Coffee Urn.....	127
Cantina®.....	77	Coffee Urn Drip Tray.....	132
Caprice™.....	66	Coffee Warmer.....	128
Caravan Brown.....	83	Coffeemaker.....	127, 128
Cascade™.....	76	Colander.....	219, 239
Catalina.....	84	Colander for Food Pan.....	239
Ceramicor™.....	69	Compartment Tray.....	144
Classic.....	66	Concession Equipment	
Conservo™.....	66	Butter Warmer.....	170
Creamer.....	86	Cheese Melter.....	169
Daring.....	79	Hot Dog Cooker.....	169, 170
Desert Sand®.....	71	Hot Dog Bun Warmer.....	169
Endurance.....	73	Pizza Merchandiser.....	169
Espree.....	64, 65	Pizza Oven.....	168, 169
Intensity.....	79	Pop Corn Popper.....	170
Kingsmen White.....	74	Pretzel Merchandiser.....	169
Mugs, Coffee.....	28, 40, 85	Snack Merchandiser, Heated.....	170, 171
Opal Reception.....	78	Soup Merchandiser.....	170
Opal Restaurant White.....	80	Condiment Bin.....	255
Ovenware.....	87-89	Condiment Caddy/Dispenser.....	133, 149
Porcelain.....	65	Condiment Dispenser Ice Pack.....	149
Porcelana Narrow Rim.....	71	Condiment Pump.....	254
Porcelana Rolled Edge.....	73	Condiment Spoon.....	134
Princess White.....	74	Condiment Table Rack.....	133, 134
Quartet.....	67	Container, Food Storage.....	194-196
Ramekin.....	90	Container, Trash.....	285
Reflections™.....	76	Convection Oven.....	176
Rego® Dunes.....	70	Cooker/Warmer.....	166
Rego® Rolled Edge & Narrow Rim.....	70	Cookie Cutter.....	249
Rolled Edge.....	64	Cookie Sheet.....	252
Royal.....	82	Cookware (See Pot & Pan).....	228-234
Sausalito.....	82	Cooling/Icing Rack.....	250
Slate.....	72	Corkscrew.....	150
Slenda®.....	77	Cover	
Sol.....	67	Cake/Pie Cover.....	117
Sugar Packet Holder.....	86, 87	Deli Crock Cover.....	118
Tea Pot.....	85	Dome Steam Table Pan Cover.....	117
Tendency.....	79	Hottle Cover.....	130
Viceroy Ultima®.....	72	Pastry Tray Cover.....	117
Vista.....	81	Pot & Pan Cover.....	236-241
Wellington Ultima.....	75	Tray Cover.....	117

Cracker Basket.....	139
Cream Server.....	130, 131
Creamer.....	86, 131, 134
Crepe Brulee Dish.....	88, 89
Crisper Bin.....	194
Crock & Lid.....	118
Cruet, Oil & Vinegar.....	30, 41, 133
Crumber, Table.....	146
Cuber.....	212
Cup & Lid Dispenser.....	142
Cup Cake Pan.....	251
Cup Dishwasher Rack.....	270-273
Cut Resistant Glove.....	199
Cutlery	
Baker's Spatula.....	201, 204, 206
Boning Knife.....	200, 202, 203, 205, 207, 209, 210
Bread Knife.....	200-203, 205, 207, 209, 210
Butcher Knife.....	200, 203
Cake Server.....	201, 204, 207
Carving Fork.....	209
Cheese Knife.....	203
Chef's Knife.....	201-203, 205, 209, 210
Clam Knife.....	202
Cleaver.....	200, 210
Cook's Fork.....	201, 204, 207
Cook's Knife.....	208
Dough Cutter.....	201, 204, 206
Fillet Knife.....	200, 201, 203, 205
Garnishing Kit.....	209
Griddle Scraper.....	201, 204, 207, 208
Hamburger Trowel.....	207
Knife Set.....	203, 204, 209
Oyster Knife.....	202
Pancake Server.....	201, 204, 207
Paring Knife.....	200, 202, 205-207, 209, 210
Parisian Cutter.....	206
Pie/Cake Server.....	201, 204, 208
Pizza Cutter.....	201, 206, 208
Pizza Server.....	206
Pot Fork.....	201, 204
Poultry Knife.....	202
Produce Knife.....	203
Sandwich Knife.....	200, 205
Sandwich Spreader.....	201, 206, 208
Santoku Knife.....	200-202, 205, 210
Shears.....	201
Slicer.....	200, 203, 205, 207, 210
Spatula.....	201, 204, 206
Steel.....	201, 203, 209, 210
Turner.....	201, 204, 207
Utility Knife.....	201, 202, 205, 209, 210
Cutlery Bin.....	276
Cutlery Case.....	200, 204
Cutlery Cylinder.....	276
Cutlery Holder.....	199, 200, 204
Cutlery Set.....	204, 209
Cutting Board.....	138, 197
Cutting Board Brush.....	197, 279
Cutting Board Mat.....	197
Cutting Board Stand.....	197
Cutting Board, Bread.....	138

D

Decanter	
Cocktail Decanter.....	31
Coffee Decanter.....	129, 130
Wine Decanter/Carafe.....	31, 41, 62, 63, 154

Decanter Brush.....	279
Deck Brush.....	294
Deck Oven.....	176
Degreaser.....	308
Deli Crock.....	118
Deodorizer.....	297, 298
Dessert Dish.....	137, 138
Diaper Changing Station.....	301
Dicer.....	212
Dinnerware.....	64-93
Dipper.....	242
Dish Caddy.....	276
Dish Cloth.....	269
Dish Rack.....	270-273
Dish Rack Dolly.....	273
Disher.....	227
Dishwashing Detergent.....	310
Dishwasher Rack.....	270-273
Dishwashing Gloves & Apron.....	269
Disinfectant.....	309
Dispenser	
All Purpose Dispenser.....	255
Bar Mix Dispenser/Container.....	148
Batter Dispenser.....	254
Beverage Dispenser.....	127-132
Cup & Lid Dispenser.....	142
Condiment Dispenser/Container.....	149
Condiment Pump Dispenser.....	254
Dressing Dispenser.....	255
Ice Cream Cone Dispenser.....	142
Iced Tea Dispenser.....	128
Napkin Dispenser.....	141
Salad Dressing Dispenser.....	298
Soap Dispenser.....	298
Squeeze Dispenser.....	253
Straw Dispenser.....	141
Toilet Tissue Dispenser.....	298, 299
Toothpick Dispenser.....	141
Towel Dispenser.....	299
Whipped Cream Dispenser.....	158
Doily.....	306
Dolly	
Camcarrier® Dolly.....	122
Glass Rack Dolly.....	270-273
Trash Container Dolly.....	285
Door Stop.....	288
Double Boiler.....	230, 231
Dough Box.....	262
Dough Cutter	
Biscuit Cutter.....	249
Cutter/Scraper.....	201, 204, 206, 220, 249, 260
Doughnut Cutter.....	249
Roller/Docker.....	260
Wheel.....	261
Dough Retarding Pan.....	258
Dredge.....	243
Drink Dispenser.....	122, 132
Drink Dispenser/Carrier.....	122
Drink Mixer, Spindle.....	156, 157
Drinkware.....	See Glassware
Drip Tray.....	132
Drum Opener.....	247
Dunnage Rack.....	180
Dust Mop Frame.....	292
Dust Mop Handle.....	292
Dust Mop Head.....	292

- Dust Pan 292
Duster 292
- E**
- Egg Poacher 229
Egg Ring 229
Egg Slicer 217
Equipment Stand 175
Erasing Pad 281
Espresso Milk Frothing Pitcher 130
- F**
- Fajita Skillet 138
Fast Food Tray 143
Faucet 274, 275
Film/Foil Dispenser 304
Filter, Baffle 282
Filter, Coffee/Tea 305
Filter, Fryer 307
Finishing Oven 169
First Aid Kit 193
- Flatware
- Arbor Rose 95
 - Baguette 96
 - Barcelona™ 97
 - Barclay™ 106
 - Belmore™ 98
 - Bosa Nova™ 105
 - Cascade™ 102
 - Chateau 94
 - Colony 100
 - Concord™ 99
 - Coral 101
 - Corelli 96
 - Delta™ 98
 - Dominion 103, 106, 108
 - Dominion III™ 100
 - Econoline Steak Knife 108
 - Elite Steak Knife 108
 - Fanfare™ 105
 - Freedom 102
 - Goddess™ 105
 - Greystoke™ 96
 - Harbour 102
 - Laguna™ 99
 - Latham 104
 - Lexington™ 98
 - Linda 101
 - Marquette 95
 - Melinda III™ 99
 - Midland™ 97
 - Monterey™ 104
 - Needlepoint 95
 - New Rim 95
 - Old English™ 98
 - Orion 96
 - Pacific Rim™ 104
 - Poise™ 104
 - Prima™ 99
 - Reflections 94, 103
 - Regency 101, 107
 - Riva™ 103
 - Royal Bristol™ 106
 - Salem 102
 - Saville™ 105
 - Scroll 94
 - Shelley 107
 - Stanford™ 97
 - Unity 94
 - Village Common™ 97
 - Wellington 101
 - Windsor III 100
 - Windsor 103, 106, 108
- Flatware Basket 273
Flatware Bin 276
Flatware Cylinder 276
Flatware Dishwashing Rack 270-273
Flatware Retriever 272
Floor Buffing Pad 295
Floor Cleaner 310
Floor Dryer 288
Floor Machine, Orbitor 288
Floor Mat 284
Floor Matting Wash Rack 284
Floor Scrub/Strip Pad and Holder 295
Floor Squeegee 295
Floor Sweeper 286, 288
Flour Brush 249
Fluorescent Bulb 301
Foil 304
Foil & Film Dispenser 190, 304
Food Bar 123
Food Blender 159-161
Food Box 194
Food Chiller 190
Food Mill 218
Food Pan 118, 237-241, 304
Food Pan Carrier 122, 123
Food Pan Colander 239
Food Pan Cover 236-241
Food Pan Drain Shelf 240
Food Pan False Bottom 238, 240
Food Pan Grate 238, 239, 250
Food Pan Roll Cover 239
Food Processor 162, 163
Food Processor Petrol Gel 212
Food Rotation Label 191-194
Food Safety 189, 190
Food Safety Temperature 182
Food Storage Container 194-196
- Food Warmer
- Bulb Warmer 114, 165
 - Butter/Cheesemelter 137, 170
 - Food Warmer Candle 125
 - Carving Station 165
 - Cooker/Warmer 166, 167
 - Heat Lamp Warmer 114, 165
 - Hot Plate/Warmer 166
 - Soup Warmer 166, 167
 - Strip Warmer 114, 165
- Fork
- Carving 207, 209
 - Cook's 201, 204, 207
 - Meat 115
 - Pot 201, 204, 207, 220
- Fountainware 29
Fragrance, Room 298
Freezer Drain Box 195
Freezer Mitt 264
French Fry Cutter 213
French Fry Rack 255
French Fry Scoop 255
Frothing Pitcher 130
Frozen Drink Mixer 157
Fry Basket 234, 235

Fry Cutter.....	213
Fry Pan.....	228, 229
Fryer.....	174
Fryer Brush.....	279, 280
Fryer Cleaner/Boilout.....	308
Fuel	
Butane Fuel.....	113
Chafing Fuel.....	112
Fuel Holder, Chafer.....	111
Lamp Fuel.....	126
Funnel.....	155, 243
Furniture.....	145
Furniture Polish.....	310

G

Garlic Press.....	215
Garnish Dispenser.....	133, 149
Garnish Dispenser Ice Pack.....	149
Garnishing Set.....	199, 209
Garnishing Tool.....	199, 209, 215
Gas Connector Kit.....	173
Glass Bowl.....	51
Glass Cleaner.....	155, 309
Glass Filler.....	274
Glass Filler Repair Kit.....	274
Glass Keeper Storage Tray.....	62
Glass Plate.....	28, 29, 41, 50, 51
Glass Dishwashing Rack.....	270-273
Glass Rimmer.....	149
Glass Washer.....	155
Glass Washer Brush.....	155
Glasses, Safety.....	300
Glassware	
Arcade Bowls.....	51
Aristocrat.....	49
Artic.....	46
Artisan.....	49
Ashbury.....	34
Ashtray.....	41, 50
Atelier.....	7
Barbary.....	36
Barrels.....	31
Beacon Hill™.....	39
Beer Mugs.....	35, 36
Bell Soda.....	21
Beverage & Beer.....	25
Bouquet.....	29
Breckenridge™.....	38
Bristol Valley.....	9
Bulge-Top Pilsners.....	37
Cabernet.....	44-46
Capri.....	42
Carafes/Pitchers.....	41
Casablanca.....	48
Cascade.....	22
Catalina®.....	13
Cervoise.....	50
Chivalry®.....	13
Cin Cin.....	50
Citation.....	10, 11
Citation Gourmet™.....	11
Clarisse™.....	37
Concord.....	39
Cruet, Oil & Vinegar.....	41
Dakota.....	18
Dessert Dish.....	41
Dinnerware.....	41, 50

Domaine.....	10
Embassy®.....	4-6
Embassy Royale®.....	7
Endeavor™.....	18
Esquire.....	20
Estate.....	12
Everest.....	18, 19
Excalibur.....	42-44
Excellency™.....	32, 33
Flare Pilsners.....	24, 25
Fleur.....	51
Florentine™.....	33, 34
Footed Beers.....	25, 26
Footed Gibraltar®.....	4
Footed.....	21
Fountainware.....	29, 30, 41
Frosted Clear Lip.....	21
Gibraltar®.....	3, 4, 29
Glass Jar & Cover.....	40
Governor Clinton®.....	21
Grande Collection.....	17
Granite®.....	47
Harmony.....	28
Heavy Base.....	19, 39
Heavy Base Pilsners.....	24
Hourglass Pilsners.....	24
Impressions.....	20
International Style Beers.....	25
Inverness™.....	17, 18
Islande.....	47
Lexington.....	14
Marbeya.....	34
Michelangelo®.....	7, 8
Millesime.....	46
Mixing Glasses.....	38
Moderno.....	28
Mugs & Tankards.....	26, 27, 40
Napa Country.....	10
New Orleans.....	32
New York.....	40
Nob Hill®.....	20
Nonic.....	49
No-Nik.....	22
Paneled Tumblers.....	18
Perception.....	11, 12
Pilsners.....	37, 50
Pitchers & Decanters.....	31
Prism.....	49
Pub & Mixing.....	50
Reality™.....	39
Regency Heavy Base.....	39
Restaurant Basics®.....	22
Rigoletto.....	8
ROC.....	51
Room Tumbler.....	20, 48
Salt & Pepper Shaker.....	41
Seabreeze Dessert Plate.....	50
Service Accessories.....	30, 41
Shetland.....	48
Shot Glass.....	36, 50
Smoking Accessories.....	31
Soho.....	38
Solace™.....	37
Specialty Glassware.....	15, 16
Specialty Shots & Shooters.....	23, 24
Specialty Stemware.....	34

- Specialty Tumblers 21
 Stack Bowls 51
 Stackable Gibraltar® 4
 Stackables™ 38
 Stacking Ashtrays 50
 Storage Jars 40
 Straight Sided 21
 Straight Sided Shells 40
 Super Sham 20
 Super Stems 15
 Tartan® 38
 Teardrop 12
 Tumblers 20, 39
 Van Gogh 8
 Vina II™ 9
 Vina™ 8, 9
 Votives & Vase 30
 Warm Beverage 28
 Weinland 35
 Weiss 35
 Whiskey Service 22
 Winchester 14
 Glassware Equivalency Chart 52-59
 Glove 269, 306
 Glove, Butcher's Cut Resistant 199
 Grater 215
 Gravy/Sauce Boat 137
 Griddle 172, 173
 Griddle Basting Cover 234
 Griddle Brick & Holder 282
 Griddle Cleaning Tool 282, 283
 Griddle Scraper 201, 204, 207, 208
 Griddle Screen, Pad & Holder 282
 Grill Brick & Holder 282
 Grill Brush 279
 Grill Cleaner 308
 Grill Cover 234
 Grill Scraper 282
 Grinder 163
 Grocery Bag 307
 Grout Brush 295
 Guest Check 303
 Guest Check Holder/Rack 145, 146
- H**
 HACCP Info 181
 Hand Blender/Mixer 162
 Hand Sink 274
 Hand Truck 285
 Handle
 Mop Handle 289, 290
 Broom Handle 294
 Brush Handle 294
 Handle Sleeve, Pot/Pan 228, 263
 Hat 268
 Healthcare Supplies
 Bowl Lid 93
 Cup Lid 93
 Meal Delivery System 93
 Pellet, Dome, Underliner & Lifter 93
 Tumbler Lid 93
 Heat Lamp 114, 165
 Heat Lamp Bulb 301
 Heat Strip 165
 Heater/Proofer Cabinet 178
 High Chair 145
 Holding Cabinet 123
 Holloware 85, 86
 Hose & Nozzle 286
 Hostess Sign 147
 Hot Dog Bun Box/Warmer 169, 170
 Hot Dog Cooker 169, 170
 Hot Dog Tray 304
 Hot Food Table 171
 Hot Plate 166, 173
 Hottle Tea/Water Server 30, 130
- I**
 Ice Caddy 153
 Ice Chipper 152
 Ice Cream Cone Dispenser 142
 Ice Cream Dish 30, 41, 137
 Ice Cream Spade 227
 Ice Scoop 152, 153, 244, 300
 Ice Scoop Holder 153, 189
 Ice Sculpture 116
 Ice Tongs 115, 152
 Ice Tote 153, 189
 Iced Tea Dispenser 128
 Icing/Pan Grate 250
 Immersion Blender 162
 Induction Cooker 113
 Ingredient Bin 195
 Insecticide 310
 Inset Hinged Cover 236
 Inset Pan & Cover 236, 239
- J**
 Jar, Barrel 31, 40
 Jelly Jar 134
 Jigger 152
 Juicer 156
- K**
 Ketchup Station/Refiller 253
 Kettle, Soup 166
 Kettle Whip 223
 Knife Holder 198
 Knife Magnetic Storage Bar 200
 Knife Rack 199
 Knife Set 204, 209
 Knife Sharpener
 Butcher's Steel 201, 203, 209
 Electric, Heavy Duty Sharpener 198
 Handheld Sharpener 198
 Sharpening Stone 198, 199, 203
 Three-way Sharpener 198, 209
 Knife Sharpening Oil 198
- L**
 Label Dispenser 191-193
 Label Gun 193
 Label, Food Rotation 191-194
 Ladle
 Deep Ladle 115
 Fruit Ladle 116
 Kitchen Ladle 224, 225
 Punch Ladle 115, 116
 Salad Bar Ladle 120
 Soup Ladle 115
 Spout Ladle 115
 Lemon Squeezer 152
 Lettuce Chopper 214
 Light Bulb 301
 Lighter 113, 126
 Lime Squeezer 152

Liquor Pourer	151
Loaf Pan.....	251
Lobster Cracker	137
Lug Box.....	177, 277

M

Malt Cup.....	152
Mandolin	215
Marker, Waterproof for Message Board	147
Mat, Bar.....	148
Mat, Floor.....	284
Matting Washing Rack	284
Meal Delivery System.....	93
Measure	242
Measuring Cup	242, 243
Measuring Spoon	242
Meat Fork.....	115
Meat Grinder.....	175, 216
Meat Mallet	216
Meat Tenderizer.....	216
Meat Tongs	115
Melon Baller.....	206
Menu Cover.....	146
Menu Stand/Holder	146
Merchandiser	
Hot Food Merchandiser.....	171
Pizza Merchandiser	169
Popcorn Merchandiser	170
Pretzel Merchandiser.....	169
Snack Merchandiser.....	170, 171
Soup Merchandiser	170
Message Board	147
Metal Cleaner/Polish	308
Microwave.....	176
Mixer	163, 164
Mixer, Spindle Drink.....	156, 157
Mixing Bowl.....	241, 242
Mixing Paddle	223
Mop	
Basting Mop.....	248
Dust Mop.....	292
Floor Wet Mop	289, 290
Mophead	289, 290
Mop Bucket/Wringer Combo.....	291
Mop Handle.....	289, 290, 292
Oil/Sauce Mop	220
Sponge Mop	290
Toilet Bowl Mop.....	296
Muddler	151
Muffin Pan.....	251
Mug.....	26-28, 40, 85

N

Napkin.....	124
Napkin Dispenser	141
Nozzle for Faucet	274
Number Stand	146
Number, Table Reservation.....	146
Nut Cracker.....	137

O

Odor Neutralizer	297, 298
Oil & Vinegar Cruet/Bottle	133
Oil Filter	307
Onion Slicer	214
Onion Soup Crock	89
Opener, Bottle.....	150

Oven	
Baking/Warming	176
Convection Oven.....	176
Deck Oven	176
Finishing Oven.....	169
Microwave Oven.....	176
Pizza Oven.....	168, 169
Roaster Oven.....	166
Oven Cleaner.....	308, 309
Oven Mitt.....	264
Ovenware	87, 88
Overflow Pipe	155
Oyster Knife	202

P

Paddle, Chilling.....	190
Paddle, Mixing	223
Pail	
Cleaning Pail.....	153
Pail with Bail.....	195
Sanitizing Pail	189
Pail Opener.....	247
Pan	
Baking Pan.....	236
Bun Pan	252
Cake Pan	250, 251
Dough Retarding Pan.....	258
Food Pan	118, 237-241, 304
Fry Pan.....	228, 229
Inset Pan.....	236
Pie Pan.....	252
Pizza Pan.....	257
Roasting Pan	236
Sauce Pan	230-233
Sheet Pan	252
Steam Table Pan	237-240, 304
Pan Carrier.....	122, 123
Pan Colander.....	239
Pan Cool Handle Sleeve	263
Pan Cover Pot/Pan.....	230-233, 236-241
Pan Detergent.....	310
Pan Drain Shelf.....	240
Pan False Bottom.....	238, 240
Pan Grabber	263
Pan Grate.....	238, 239, 250
Pan Gripper	259
Pan Liner, Sheet	304
Pan Rack	178, 259
Pan Roll Cover.....	239
Pan Scrubber.....	280, 281
Pancake Batter Dispenser & Stand	254
Panini Sandwich Press.....	172
Pants, Chef	266
Paper Plate	305
Paper Towel Dispenser	299
Party Pick.....	305
Pasta Basket.....	234
Pastry Bag	250
Pastry Blender.....	249
Pastry Brush	248
Pastry Case	117
Pastry Server	114, 115
Pastry Tongs	114
Pastry Tray Cover.....	117
Peeler.....	215, 216
Pepper Mill.....	134
Pick, Party/Bar	305

Pie Knife.....	207
Pie Marker.....	252
Pie Pan.....	252
Pie Server.....	114, 115, 201, 204, 206-208, 261
Pilsner.....	13, 24
Piping Tip Set.....	250
Pitcher.....	31, 41, 62, 63, 128, 130, 137
Pizza Supplies	
Pizza Baking Disc.....	257
Pizza Box Support.....	262
Pizza Bubble Popper.....	259
Pizza Cutter.....	201, 203, 206, 260, 261
Pizza Delivery Bag.....	262
Pizza Display Case.....	169
Pizza Dough Box.....	262
Pizza Knife.....	260
Pizza Oven.....	168, 169
Pizza Oven Brush.....	279
Pizza Pan.....	257
Pizza Pan Rack.....	259
Pizza Peel.....	258
Pizza Screen.....	258
Pizza Screen Rack.....	259
Pizza Server.....	206
Pizza Stand.....	259
Placemat.....	306
Plastic Bar Drinkware.....	61
Plastic Dinnerware.....	90-93
Plastic Tumbler.....	59-61
Platter Basket, Fast Food.....	140
Platter, Sizzling.....	138
Plunger.....	296
Popcorn Popper.....	170
Pot	
Brazier.....	232
Double Boiler.....	230, 231
Sauce Pot.....	230, 231, 233
Stock Pot.....	230, 232-234
Pot Cool Handle Sleeve.....	263
Pot Cover.....	230-233, 236-241
Pot Detergent.....	310
Pot Fork.....	201, 204, 207, 220
Pot Gloves.....	269
Pot Holder.....	263
Pot Pie Dish.....	87
Pot Rack.....	271
Pot Scrubber.....	280, 281
Potato Brush.....	248
Potato Cutter.....	213
Potato Masher.....	217
Potato Press.....	217
Potato Ricer.....	217
Potato Scooper.....	211
Pourer.....	151
Pre-Rinse Unit.....	274
Pre-Rinse Unit Parts/Repair Kit.....	275
Pre-Rinse Wall Bracket.....	275
Pretzel Merchandiser.....	169
Probe Wipe, Thermocouple.....	183
Pulp Extractor.....	156
Pump, Condiment.....	253, 254
Pump, Plastic Jug.....	299
Punch Bowl.....	116
Punch Ladle.....	115, 116
Push Broom.....	294

R

Rack

Guest Check Rack.....	146
Syrup Dispenser Rack.....	133
Bun Pan Rack.....	177, 178
Can Rack.....	178
Condiment Table Rack.....	133, 134
Cruet Rack.....	41
Dishwasher Rack.....	270-273
Dunnage Rack.....	180
Ramekin.....	30, 87, 90, 91
Range, Portable.....	113
Rarebit.....	87-89
Register Roll.....	303
Relish Dish.....	30
Reserved Table Sign, Number & Stand.....	146
Restroom Sign.....	300
Rethermalizer.....	166
Rice Cooker.....	177
Roast Pan.....	236
Roaster Oven.....	166
Roaster Pan.....	236
Roller Docker.....	260
Rolling Pin.....	249

S

Safety Glasses.....	300
Salad Bar Accessories.....	114, 118-121
Salad Bar Utensil.....	114, 120, 121
Salad Bowl.....	51, 91, 116, 119
Salad Dressing Dispenser.....	255
Salad Plate.....	28, 29, 50, 51
Salad Spinner.....	214
Salad Tongs.....	114, 121
Salsa Dish.....	91
Salt & Pepper Refiller.....	136
Salt & Pepper Shaker.....	30, 41, 135
Sand Urn.....	285
Sandwich Pick.....	305
Sandwich Press/Grill.....	172
Sandwich Spreader.....	201-203, 206-208
Sandwich Wrap.....	304
Sanitary Napkin Receptacle.....	297
Sanitizing Pail.....	189
Sanitizing Tablet.....	155
Sauce/Gravy Boat.....	137
Sauce Cup.....	30, 137
Sauce Pan.....	230-233
Sauce Pot.....	230, 231, 233
Scale.....	244, 245, 246
School Tray.....	144
Scissors, Kitchen.....	199, 201
Scoop.....	152, 153, 189, 244, 300
Scoop Holder.....	189
Scouring Pad.....	280, 281
Scrap Block.....	272
Scraper.....	220, 221
Scrub Brush.....	280, 294
Scrubber.....	280-282
Scrubber Holder.....	282
Seafood Sauce Cup.....	30
Serrator.....	217
Server, Syrup.....	255
Shaker	
Cheese Shaker.....	136
Dredge.....	243

Salt & Pepper Shaker	41, 134, 135	Spreader	201-203, 206-208
Sharpener, Knife	198, 199, 201, 203, 209	Springform Pan	250, 251
Shears, Kitchen	199, 201	Squeegee	283, 295
Sheet Pan	235, 252	Squeeze Dispenser	253
Sheet Pan Liner	304	Stainless Steel Cleaner	308
Sheet Pan Mat	252	Stanchion, Crowd Control	147
Sheet Pan Rack	178	Steak Knife	108, 109
Shelf Liner	148	Steak Platter, Sizzling	138
Shelving	179	Steak Weight	220
Sherbet Dish	30, 30, 41, 137	Steam Table	171
Shirred Egg Dish	88	Steam Table Pan	237-240, 304
Shirt, Cooks	266	Steam Table Pan Colander	239
Shooter	23, 24, 151	Steam Table Pan Cover	236-241
Shortening Filter	307	Steam Table Pan False Bottom	238, 239
Shot Glass	24, 36, 50, 61	Steam Table Pan Grate	238, 239
Sieve	249	Steam Table Pan Guide	237
Sign		Steam Table Pan Roll Cover	239
Employees Must Wash Sign	300	Steamer	177
Employees Only Sign	300	Steel, Butchers	201, 203, 209, 210
Hostess Sign	147	Step Stool	285
Men Sign	300	Stock Pot	230, 232-234
No Pets	300	Stopwatch	188
No Smoking	300	Store 'N Pour Bar Mix Container	148
Open Sign	147	Stove, Portable	113
Pizza Sign	147	Strainer	218
Reserved	146	Straw Dispenser	141
Restrooms	300	Sugar Packet Holder	30, 86, 87
Shoes & Shirt Required	300	Sugar Pourer	136
Women Sign	300	Sundae Dish	29, 41
Silverware Bin for Cart	278	Supreme & Liner	29
Silverware Retriever	272	Sweep Handle	294
Sink	275	Sweeper	286, 288
Sink Gloves	269	Syrup Dispenser	133, 137
Sizzling Platter & Underliner	138	Syrup Dispenser Rack	133
Skewer	220	Syrup Pitcher	134
Skillet	229	Syrup/Creamer	86
Skillet Dish	89	T	
Skillet, Fajita Server	138	Table Candle	126
Skimmer	219	Table Condiment Rack	133, 134
Skirting	124	Table Crumber	146
Slicer Cleaner	190	Table Lamp	126
Slicer	175	Table Lamp Fuel	126
Smoking Receptacle	31, 41, 50, 154, 285	Table Level/Glide	144
Smoking Sign	300	Table Number & Stand	146
Soap Dispenser	298	Table Skirting	124
Soap Pad	281	Tablecloth	124
Soda Glass	29, 41	Tableware Retriever	272
Souffle	88	Taco Rail	234
Soup Bowl	89	Taco/Tostada Fry Basket	234, 235
Soup Kettle	166	Taper Candle	125
Soup Ladle	115	Tea Dispenser	128
Soup Merchandiser	170	Tea Gooseneck Server	85
Spaghetti Tongs	222	Tea Light Candle	125, 126
Spatula	201, 204, 206, 220, 221	Tea Pot	85
Speed Rail	150	Thermometer	
Spillage Pan	236	Candy Thermometer	184, 186, 188
Spindle Drink Mixer	156, 157	Deep Fry Thermometer	185
Sponge	280, 281	Dishwasher Thermometer	185, 190
Sponge Mop	290	Disposable Thermometer	183, 185, 190
Spoodle	225	Grill Thermometer	185, 186
Spoon		Heated Holding Thermometer	185, 186
Basting Spoon	226	Infrared Thermometer	183, 187
Condiment Spoon	134	Meat, Disposable Thermometer	190
Portion Control Spoon	225, 226	Milk/Beverage Thermometer	184
Serving Spoon	114, 115, 120	Oven Thermometer	184, 186, 187
Sprayer & Bottle	300	Pocket Thermometer	183-188

Refrigerated Equipment Thermometer	183-187	Urinal Toss Block	297
Thermocouple.....	185	Urn Brush.....	279
Thermometer Probe Wipe.....	183	Urn Drip Tray	132
Thermometer Sanitizer.....	183, 184	Urn, Coffee.....	127
Tiered Bin, Condiments/Straws	255	Urn, Sand.....	285
Timer	188	V	
Toaster	168	Vacuum Cleaner	287
Toilet Bowl Brush & Mop	296	Vacuum Cleaner Bag & Belt	287
Toilet Bowl Cleaner.....	310	Vacuum Pack Bag	174
Toilet Plunger	296	Vacuum Pack Machine.....	174
Toilet Seat Cover	297	Vase	30
Toilet Tissue Dispenser	298, 299	Vegetable Brush	248
Tomato Corer.....	215	Vegetable Cooker.....	234
Tomato Scooper	211	Vegetable Crisper	194
Tomato Slicer.....	211	Vegetable Peeler	216-217
Tongs		Vegetable Slicer.....	212
Color Coded Tongs.....	121, 223	Votive Holder	30
Ice Tongs.....	115, 152	W	
Kitchen Tongs	222	Waffle Maker.....	167
Meat Tongs	115	Wall Shelf.....	180
Pastry Tongs.....	114, 115	Warewashing	270-273
Pom Tongs.....	121, 222	Wastebasket	286
Salad Tongs	114, 121	Water Filter.....	128
Scalloped Utility Tongs	222, 223	Water Pitcher	63, 128
Serving Tongs.....	114, 115	Wax Paper	304
Spaghetti Tongs.....	222	Wedger	212
Utility Tongs.....	121, 222, 223	Welsh Rarebit	87-89
Tool Hanger	294	Wet Floor Sign	291, 292
Toothpick.....	305	Whip	223, 224
Toothpick Dispenser	141	Whipped Cream Charger	158
Torch, Chef.....	113	Whipped Cream Dispenser.....	158
Tortilla Server.....	138	Whiskey Glass.....	23, 24
Tortilla Warmer.....	138	Whiskey Pourer	151
Tostado/Taco Fry Basket.....	234	Wine Bucket.....	153, 154
Tote Box.....	276, 277	Wine Bucket Stand.....	153, 154
Towel.....	268, 269	Wine Cooler	153, 154
Towel Dispenser/Cabinet	299	Wine Decanter.....	31
Trash Can Liner.....	307	Wok	256
Trash Container for Cart.....	278	Wok Brush	256
Trash Container, Top & Dolly.....	285	Wok Ring	256
Tray		Wrap & Foil Dispenser	190
Bar Tray.....	143	Wrap, Food	304
Buffet Tray.....	91, 92, 114, 116	Write On Board.....	147
Compartment Tray.....	144	Y	
Fast Food Tray.....	143	Youth Chair	145
Healthcare Tray	93	Z	
Pastry Tray.....	116, 117	Zester	215
School Tray	144		
Serving Tray.....	114		
Tray Cover	117		
Tray Stand	144, 145		
Tumbler.....	59-61		
Turner			
Cake Turner	204, 207, 208		
Hamburger Turner	201, 204, 207, 208, 219		
Long Handle Turner.....	207		
Mini Turner	201, 204		
Pancake Turner	204, 207, 208		
Perforated Turner.....	115, 201, 204, 207, 219		
Slotted Turner	219		
Steak Turner	201		
U			
Urinal Deodorizer.....	297		
Urinal Descaler	297		
Urinal Floor Mat	296		
Urinal Screen.....	297		

**Published by CFI Marketing –
Jacksonville, FL 2011**

This catalog is made available to you by CFI Marketing and remains the property of CFI Marketing. No part of this catalog can be reproduced without the specific written consent of CFI Marketing. All rights reserved.

GUIDE TO STEAMTABLE PANS

Complete flexibility for steam table service is available through a wide range of sectional pans which includes... Full Size, 2/3 Size, 1/2 Size, 1/2 Long Size, 1/3 Size, 1/4 Size, 1/6 Size and 1/9 Size. All are made to fit both 19 7/8" x 11 7/8" or 20" x 12" openings. This extensive line makes countless combinations available for meeting specific individual requirements. All pans are seamless with smooth, rounded corners for easy cleaning and quick serving.

Size	Width (L to R)	Length (F to B)	Size	Width (L to R)	Length (F to B)
Full	12 3/4"	20 3/4"	1/3	12 3/4"	6 7/8"
1/2	12 3/4"	10 3/8"	1/6	6 1/4"	6 7/8"
1/4	6 3/8"	10 3/8"	1/9	4 1/4"	6 7/8"
2/3	12 3/4"	13 7/8"			

Standard depths are 2 1/2", 4" and 6". Adapter bars in 12" or 20" lengths are needed when your arrangement gives unsupported corners. A variety of lid sizes and types are available.

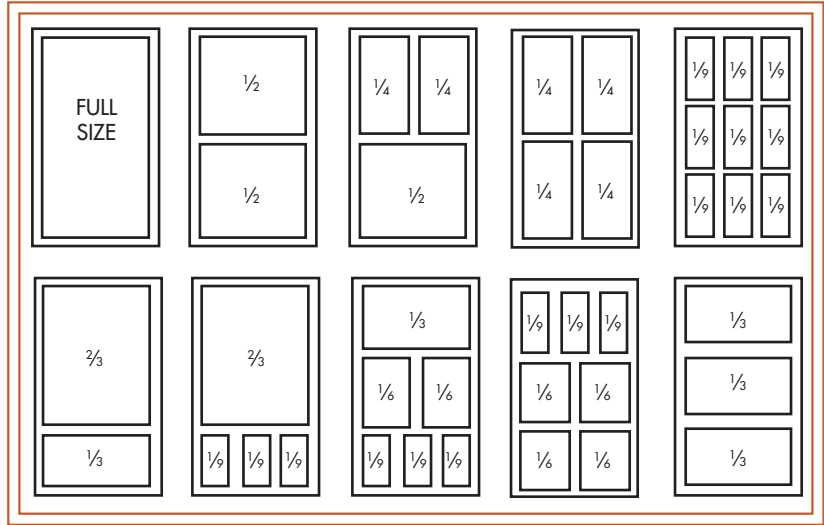

KITCHEN MEASUREMENT CONVERSION TABLE

Read down: 1/4 cupful = 1 fluid dram

Units	Fluid dram	Tea spoonful	Table spoonful	Fluid ounce	1/4 cupful	Gill (1/2 cupful)	Cupful	Liquid pint	Liquid quart	Milliliter	Liter
1 fluid dram	1	3/4	1/4	1/8	1/16	1/32	1/64	1/128	1/256	3.7	0.004
1 teaspoonful	1/3	1	1/3	1/6	1/12	1/24	1/48	1/96	1/192	4.9	0.005
1 tablespoonful	4	3	1	1/2	1/4	1/8	1/16	1/32	1/64	15	0.015
1 fluid ounce	8	6	2	1	1/2	1/4	1/8	1/16	1/32	30	0.030
1/4 cupful	16	12	4	2	1	1/2	1/4	1/8	1/16	59	0.059
1 gill (1/2 cupful)	32	24	8	4	2	1	1/2	1/4	1/8	118	0.118
1 cupful	64	48	16	8	4	2	1	1/2	1/4	237	0.237
1 liquid pint	128	96	32	16	8	4	2	1	1/2	473	0.473
1 liquid quart	256	192	64	32	16	8	4	2	1	946	0.946

SOUP-SAUCE LADLES

SIZE

1 oz 2 oz 4 oz 6 oz 8 oz

EQUIVALENT

1/8 cup 1/4 cup 1/2 cup 3/4 cup 1 cup

DISHER CAPACITY CHART

Color	Disher Size	Bowl Dia	Fluid Oz*	Wt Oz*	Patties/Lb †	Scoops/Gal ††	Equivalent
White	6	3"	4.66	4.86	3	16	2/3 Cup
Gray	8	2 3/4"	3.64	3.80	3 1/2	22	1/2 Cup
Ivory	10	2 5/8"	3.19	3.33	4	24	5/8 Cup
Green	12	2 1/2"	2.78	2.90	5	26	1/3 Cup
Blue	16	2 1/4"	2.07	2.16	6-8	35	1/4 Cup
Yellow	20	2 1/8"	1.77	1.84	9-10	42	3+ Tbsp
Red	24	2"	1.49	1.56	11-12	51	2 2/3 Tbsp
Black	30	1 3/4"	1.03	1.07	13-14	62	2+ Tbsp
Orchid	40	1 1/2"	0.68	0.70	15-16	70	1 1/2 Tbsp

* Water Capacity † Hamburger Patties †† Ice Cream Scoop

32 DEGREES IDEAL

Store in back of cooler

ITEM	TEMP. °F	STORAGE
Apples*	31°-32°	Avoid excess movement. Do not rinse.
Broccoli	32°-35°	Store in covered box with drain shelf
Cabbage	32°-35°	Leave wrapper leaves on. Store covered.
Cantaloupe*	38°-42°	Ripen at room temperature.
Carrots	32°-35°	Do not wash until ready to serve.
Cauliflower	32°-35°	Store in original shipping crate, single layers. Store only briefly.
Celery	32°-35°	Keep covered and sprinkle with water.
Corn	32°-34°	Store in original cartons and stack for good air flow.
Grapes*	32°-40°	Store in original cartons. Air circulation causes shriveling. Store only briefly.
Lettuce	32°-35°	Store tightly with drain shelf or colander
Mushrooms*	34°-40°	Put in cooler immediately. Keep dry.
Oranges* (FL)	32°-35°	Need good air circulation. Use dunnage rack.
Peaches	32°	Store at 65°-70°F until ripened.
Pears*	32°-35°	Store at 60°-65°F until ripened.
Radishes	32°	Rinse, remove tops, and drain before storing in covered containers.
Strawberries	32°-35°	Store in original carton. Do not wash or trim before storing. Store only briefly.

45-55 DEGREES IDEAL

Store in warmest part of cooler or coolest section of kitchen.

ITEM	TEMP. °F	STORAGE
Avocados*	40°-45°	Handle gently. Ripen at room temperature.
Cucumbers	45°-50°	Do not wash or sprinkle with water.
Lemons*	45°-50°	Absorb odors easily.
Onions	45°-50°	Keep cool, dry, and ventilated.
Oranges*(CA)	45°-50°	Proper rotation will maintain good fruit.
Peppers	45°-50°	Very susceptible to chill damage.
Pineapple	45°-50°	Won't ripen after harvest. Handle gently.
Squash	40°-55°	Soft shell cooler than hard shell.

55-65 DEGREES IDEAL

Store in coolest part of kitchen. Do not refrigerate.

ITEM	TEMP. °F	STORAGE
Bananas*	56°-60°	Open lid to avoid too quick ripening.
Potatoes	60°-70°	Store in dark area. Cooler temperatures cause accumulation of sugar.
Tomatoes*	55°-65°	Keep out of direct sunlight. Stack palettes to accelerate ripening.
Watermelons*	50°-60°	Store green side up. Cut pieces should be stored in the cooler.

COOLER TEMPERATURE RANGES

STORE OUTSIDE COOLER

Potatoes	Tomatoes
Bananas	Onions
Lemons	Limes

COOLER

FRONT 40° - 45°

Melons	Eggplant
Citrus	Avocados
Cantaloupe	Red Potatoes
Pineapple	Peppers
Green Beans	Summer Squash
Cucumbers	

MIDDLE 35° - 39°

Squash	Herbs
Zucchini	Pears
Sprouts	Parsley
Green Onions	

BACK 33° - 35°

Artichokes	Apples
Asparagus	Apricots
Broccoli	Blueberries
Carrots	Cabbage
Cauliflower	Corn
Celery	Kiwi
Cherries	Leaf Lettuce
Grapes	Mushrooms
Peaches	Strawberries
Radishes	

WHAT IS ETHYLENE GAS?

Items marked with an asterisk (*) produce ethylene gas, an active plant hormone required for the ripening process. While this is good in certain quantities, some produce can be damaged by ethylene gas exposure, especially leafy vegetables. Be sure to arrange your produce carefully.

SUGGESTED REQUIREMENTS FOR A 100-SEAT RESTAURANT†

For additional suggested seating requirements visit www.nafem.org/information-resources/smallwaresrequirements.aspx

Quantity	Item Description	Quantity	Item Description
GLASSWARE			
_____ 12 dz	5 oz juice	_____ 2 ea	Cocktail strainer
_____ 12 dz	12 oz iced tea	_____ 2 ea	Stainless steel ice scoop
_____ 20 dz	10 oz water goblet	_____ 2 ea	Jumbo can tapper
_____ 12 dz	6 oz sherbet	_____ 2 ea	Bottle cap lifter
_____ 12 dz	5½ oz flute	_____ 1 set	Salt & pepper shaker
_____ 10 dz	Sugar packet holder	_____ 1 ea	Wine opener
_____ 3 dz	Salt & pepper shaker	_____ 1 ea	Muddler
_____ 2 dz	Ashtray	_____ 1 ea	Zester
DINNERWARE			
_____ 20 dz	Dinner plate	_____ 2 ea	Condiment caddy
_____ 20 dz	Salad plate	_____ 2 ea	Bar caddy
_____ 10 dz	Platter	_____ 1 set	Drink mix system with back up gallons, pints & quarts
_____ 9 dz	Soup/salad bowl	_____ 2 ea	10" stainless bar spoon
_____ 10 dz	Bouillon	_____ 1 ea	Glass rimmer
_____ 20 dz	Fruit	_____ 12 ea	Ashtray
_____ 8 dz	Coffee/tea cup	_____ 3 ea	Bar mat
_____ 8 dz	Coffee/tea cup saucer	_____ 2 ea	Service mat
_____ 8 dz	18 oz nappie	_____ 6 ea	Tip tray
_____ 20 dz	Bread and butter	_____ 6 ea	Wine cooler & stand
_____ 10 dz	5 oz ramekin	_____ 12 ea	Waiter's corkscrew
_____ 5 dz	12 oz rarebit	BAR GLASSES	
FLATWARE			
SPOONS			
_____ 30 dz	Teaspoon	_____ 3 dz	Wine
_____ 15 dz	Dessert	_____ 1 dz	Carafe
_____ 2 dz	Tablespoon	_____ 12 dz	Beer
_____ 15 dz	Iced tea	_____ 1 dz	Pitcher
_____ 15 dz	Bouillon	_____ 6 dz	Rocks
_____	Demitasse **	_____ 4 dz	Double rocks
FORKS			
_____ 15 dz	Salad/dessert	_____ 12 dz	Collins
_____ 30 dz	Dinner	_____ 4 dz	Martini
_____ 12 dz	Cocktail	_____ 2 dz	Irish coffee
KNIVES			
_____ 20 dz	Dinner knife	_____ 3 dz	Sour
_____ 15 dz	Utility/dessert knife	_____ 2 dz	Champagne
_____ 15 dz	B&B Knife or butter spreader	ENTRANCE LOBBY	
_____	Steak Knife **	_____ 1 ea	Sand urn
_____	Fish Knife **	_____ 1 ea	Menu board
Note: **Accessory items to be considered separately, depending upon type of service and menu.			
BAR SERVICE			
_____ 2 ea	8" x 12" lemon board	_____ 1 ea	Toothpick dispenser
_____ 2 ea	Paring knife	_____ 1 ea	Mint tray
_____ 1 ea	Drink mixer	_____ 60 ea	Menu cover
_____ 2 ea	Cocktail shaker	TABLETOP ACCESSORIES	
_____ 6 ea	Mixing glass	_____ 84 ea	Salt & pepper shaker
_____ 24 ea Ashtray			
_____ 60 ea Bread basket			
_____ 12 ea 12 oz S/S or china creamer			
_____ 36 ea Sugar pack holder			
_____ 36 ea Table tent			
_____ 12 ea Oil & vinegar set			
_____ 36 ea Bud vase			
_____ 36 ea Table lamp			
_____ 36 ea Napkin dispenser			

SUGGESTED REQUIREMENTS FOR A 100-SEAT RESTAURANT†

For additional suggested seating requirements visit www.nafem.org/information-resources/smallwaresrequirements.aspx

Quantity	Item Description	Quantity	Item Description
BUFFET			
HOT TABLE			
_____ 3 ea	20½" adapter bar	_____ 2 ea	2 element coffee warmer
_____ 6 ea	12½" adapter bar	_____ 2 ea	Decaf coffee decanter
_____ 6 ea	Insert pan full 2½" deep	_____ 2 ea	Regular coffee decanter
_____ 4 ea	Insert pan full 4" deep	_____ 4 ea	64 oz Coffee pitcher
_____ 2 ea	Insert pan full 2½" deep, perforated	_____ 1 ea	Iced tea urn
_____ 4 ea	Insert pan half 2½" deep	_____ 4 ea	Iced tea pitcher w/ice guard
_____ 4 ea	Insert pan half 4" deep	_____ 4 ea	Water pitcher w/ice guard
_____ 1 ea	Insert pan half 2½" deep, perforated	_____ 2 ea	Gel filled refreezing crock for non dairy creamers
_____ 6 ea	Insert pan one third 2½" deep	_____ 2 ea	Gel filled refreezing crock for lemon wedges w/lid and 6" ice tong
_____ 4 ea	Insert pan one third 4" deep	_____ 2 ea	12 ounce stainless steel ice scoop
_____ 4 ea	Insert cover full w/notch	_____ 6 ea	14" rubber coated nonslip beverage tray
_____ 6 ea	Insert cover half w/notch	_____ 8 ea	22" x 27" oval rubber coated non-slip waiter's tray
_____ 6 ea	Insert cover one third w/notch	_____ 12 ea	Chrome tray stand w/rubber feet
_____ 4 ea	8 quart vegetable inset w/cover	_____ 1 ea	12" x 14" stainless steel dessert tray
_____ 2 ea	8 oz food portioner, solid	_____ 1 ea	6 hole flatware dispenser w/cylinders
_____ 2 ea	8 oz food portioner, perforated	_____ 1 ea	Silver bin
_____ 2 ea	4 oz food portioner, solid	_____ 6 ea	2 way booster seat
_____ 2 ea	4 oz food portioner, perforated	_____ 6 ea	High chair
_____ 1 ea	Thumb activated disher #8	_____ 12 ea	Tip tray
_____ 1 ea	Thumb activated disher #12	_____ 12 ea	Check minder
_____ 4 ea	13" spoon, solid	_____ 12 ea	Crumb tray w/crumber
_____ 4 ea	13" spoon, perforated	FOOD PREPARATION	
_____ 2 ea	13" spoon, slotted	SALAD PREPARATION	
_____ 2 ea	12" tongs	_____ 2 ea	Apron
_____ 1 ea	2 bulb heat lamp	_____ 2 ea	16 qt aluminum colander
_____ 1 ea	Insert pan 2½" deep w/pan grate	_____ 2 ea	18" x 24" x ½" Cutting board (green)
_____ 1 ea	4 ounce ladle	_____ 1 ea	10" cook's knife
_____ 1 ea	8 ounce ladle	_____ 3 ea	Utility knife
_____ 60 ea	2½ ounce S/S oyster cocktail cup	_____ 3 ea	Paring knife
BUFFET WARE			
STAINLESS			
_____ 1 ea	15" spoon, solid	_____ 4 ea	8 qt stainless steel bowl
_____ 1 ea	15" spoon, perforated	_____ 2 ea	13 qt stainless steel bowl
_____ 1 ea	15" spoon, slotted	_____ 1 ea	Bucket opener
_____ 3 ea	13" spoon, solid	_____ 4 ea	Large blade spatula
_____ 3 ea	13" spoon, perforated	_____ 1 ea	Stainless box grater
_____ 1 ea	13" spoon, slotted	_____ 4 ea	Vegetable peeler
LADLES			
_____ 2 ea	2 ounce	_____ 1 ea	Parer/corer
_____ 4 ea	4 ounce	_____ 1 ea	Egg slicer
_____ 2 ea	6 ounce	_____ 1 ea	Egg divider
_____ 4 ea	8 ounce	_____ 1 ea	Lemon/tomato wedger
_____ 2 ea	12 ounce	_____ 1 ea	Melon baller
TONGS			
_____ 2 ea	16" spring tongs	_____ 1 ea	Apple divider
_____ 4 ea	12" spring tongs	_____ 2 ea	Vegetable brush
_____ 4 ea	9" spring tongs	_____ 1 ea	Commercial food processor
MEAT, POULTRY, FISH PREPARATION			
_____ 1 ea	18" x 24" x 1" cutting board (red)	_____ 1 ea	Table mount can opener
_____ 1 ea	18" x 24" x 1" cutting board (blue)		
_____ 1 ea	18" x 24" x 1" cutting board (yellow)		
_____ 1 ea	Meat slicer, electric		

†Suggested quantities are only a guide. Your quantities may vary based on your operational needs.

SUGGESTED REQUIREMENTS FOR A 100-SEAT RESTAURANT†

For additional suggested seating requirements visit www.nafem.org/information-resources/smallwaresrequirements.aspx

Quantity	Item Description	Quantity	Item Description
MEAT, POULTRY, FISH PREPARATION CONTINUED			
_____	1 ea 2 lb x 1/8 oz platform scale, fixed dial		
_____	1 ea 2 lb rotating dial scale		
_____	1 ea Film dispenser		
_____	1 ea Foil dispenser		
_____	2 ea Bowl scraper, large blade		
_____	4 ea 8 qt stainless steel mixing bowl		
_____	4 ea 6 qt stainless steel mixing bowl		
_____	1 ea 4 qt stainless steel mixing bowl		
_____	2 ea 10" cook's knife		
_____	2 ea 8" utility knife		
_____	1 ea 10" bread knife		
_____	1 ea 6" boning knife		
_____	1 ea 7" cleaver		
_____	1 ea Butcher steel		
_____	1 ea Stainless knife rack		
BAKE PREPARATION			
_____	3 sets Measuring spoon		
_____	1 set Dry measure, alum. (1/2 qt, 1 qt, 2 qt, 4 qt)		
_____	1 set Liquid measure, alum. (1/2 qt, 1 qt, 2 qt, 4 qt)		
_____	1 ea 1 cup measure		
_____	1 ea 24 ounce aluminum scoop		
_____	1 ea 84 ounce aluminum scoop		
_____	1 ea Stainless steel rotary sifter		
_____	1 ea 14" aluminum sieve		
_____	2 ea Dough scraper		
_____	1 ea 18" maple rolling pin		
_____	1 ea Biscuit cutter		
_____	2 ea Large blade spatula		
_____	2 ea 2 1/2" pastry brush		
_____	2 ea Spring form pan		
_____	4 ea 10" x 1 1/2" cake pan		
_____	12 ea 9" pie pan		
_____	1 ea 7 cut pie marker		
_____	6 ea 24 cup muffin pan		
_____	24 ea 18" x 26" x 1" sheet pan		
_____	1 ea Sheet pan rack w/casters		
_____	2 ea 24" oven mitts		
_____	9 ea 18" x 26" x 3" dough box		
_____	1 ea Dough box transport dolly		
COOKING			
STOCK POTS			
_____	2 ea 40 qt stock pot w/cover		
_____	2 ea 32 qt stock pot w/cover		
_____	3 ea 20 qt stock pot w/cover		
SAUCE POTS			
_____	2 ea 14 qt sauce pot w/cover		
_____	2 ea 10 qt sauce pot w/cover		
BRAZING PANS			
_____	1 ea 18 qt brazier		
SAUCE PANS			
_____	3 ea 8 qt sauce pan		
_____	2 ea 5 qt sauce pan		
_____	2 ea 3 qt sauce pan		
_____	2 ea 2 qt sauce pan		
_____	2 ea 1 qt sauce pan		
FRY PANS			
_____	2 ea 14" aluminum fry pan		
_____	6 ea 12" aluminum fry pan		
_____	12 ea 10" aluminum fry pan		
_____	4 ea 8" aluminum fry pan		
DOUBLE BOILER			
_____	1 ea Large aluminum double boiler (17-20 qt)		
_____	1 ea Medium aluminum double boiler (10-15 qt)		
FRYER STATION			
_____	1 ea Culinary fry basket 1/4" mesh		
_____	1 ea 5 x 6" fine mesh skimmer		
_____	1 ea 16" tongs		
_____	1 ea 2 bulb heat lamp		
_____	1 ea Insert pan full 2 1/2" deep w/pan grate		
_____	1 ea Seasoning dredge		
_____	1 ea Fryer thermometer 50° - 550°		
_____	1 pr Grease proof oven mitt		
_____	1 ea Grease filter cone		
_____	1 cs Grease filter		
GRILL STATION			
_____	3 ea 16" tongs		
_____	1 ea 4" x 8" blade large turner		
_____	1 ea 2 3/4" x 8" blade medium turner		
_____	1 ea Grill brush		
_____	1 pr Oven mitt, flame retardant		
_____	2 ea Sauce mop		
_____	1 ea Insert pan one fourth 4" deep (for butter)		
_____	1 ea 21" S/S meat fork w/hook handle		
_____	2 ea Steak weight 9 1/2" x 5 3/4" - 3 lb iron		
_____	2 ea Toast/bacon weight 11 x 9" - 2 lb aluminum		
GRIDDLE STATION			
_____	1 ea 4" x 8" blade large turner		
_____	1 ea 2 3/4" x 8" square end blade turner		
_____	1 ea Grill scraper		
_____	1 ea Steak weight 9 1/2" x 5 3/4" - 3 lb iron		
_____	1 ea Toast/bacon weight 11 x 9" - 2 lb aluminum		
_____	1 ea Batter/oil dispenser		
_____	1 ea Grill brick holder		
_____	1 cs Grill brick		

†Suggested quantities are only a guide. Your quantities may vary based on your operational needs.

SUGGESTED REQUIREMENTS FOR A 100-SEAT RESTAURANT†

For additional suggested seating requirements visit www.nafem.org/information-resources/smallwaresrequirements.aspx

Quantity	Item Description	Quantity	Item Description
GRIDDLE STATION CONTINUED			
_____ 1 ea	Butter wheel	_____ 2 ea	36" dunnage rack
_____ 2 ea	Stainless steel seasoning dredge	_____ 2 ea	36 gallon ingredient bin w/slide cover
_____ 1 ea	Griddle thermometer	_____ 6 ea	Polycarbonate food box, 18" x 26" x 15"
STRAINERS			
_____ 1 ea	10" china cap medium mesh	_____ 6 ea	Polycarbonate food box, 18" x 26" x 9"
_____ 1 ea	8" fine mesh	_____ 6 ea	Polycarbonate food box, 12" x 18 x 9"
_____ 2 ea	8" double medium mesh	_____ 6 ea	8 qt round storage container w/lid
_____ 1 ea	10" double medium mesh	BUS STATION/WAREWASHING	
_____ 1 ea	14" reinforced double medium mesh	_____ 2 ea	3 tier bus cart
_____ 1 ea	8" dia bouillon strainer	_____ 12 ea	7" tall bus tub
_____ 1 ea	6" Perforated stainless skimmer	_____ 2 ea	Manual carpet sweeper
_____ 1 ea	Culinary fry basket, 1/4" mesh	_____ 1 ea	Lobby dust pan w/toy broom
THERMOMETERS			
_____ 2 ea	0° - 220° pocket test 6" calibratable stem	_____ 2 ea	Rubber coated apron
_____ 2 ea	50° - 550° pocket test 6" calibratable stem	_____ 3 pr	Insulated gloves
_____ 1 ea	50° - 550° kettle thermometer with side clip	_____ 1 ea	Scrap block
As needed	Candy thermometer	_____ 15 ea	36 compartment glass rack
As needed	Oven thermometer	_____ 5 ea	Plate/tray rack
As needed	Refrigerator thermometer	_____ 5 ea	Multipurpose rack
STORAGE			
GENERAL STORAGE			
_____ 1 ea	200 lb receiving scale	_____ 4 ea	Flat rack
_____ 1 ea	Box knife	_____ 1 ea	Rack dolly
_____ 2 ea	36" dunnage rack	_____ 24 ea	Poly cylinder
COLD STORAGE			
_____ 2 ea	36" dunnage rack	_____ 1 ea	Max. hold dishwasher thermometer
_____ 12 ea	Polycarbonate food box, 18" x 26" x 15"	_____ 2 pr	Insulated rubber glove
_____ 6 ea	Drain trays for food box, 18" x 26"	_____ 1 ea	20" pot brush
_____ 12 ea	Polycarbonate food box, 12" x 18" x 9"	_____ 2 ea	8" pot brush
_____ 6 ea	Polycarbonate food box, 12" x 18" x 6"	_____ 2 ea	General pan brush
_____ 6 ea	8 qt round storage container w/lid	_____ 1 ea	Triple glass brush
_____ 12 ea	3.5 qt round storage container w/lid	_____ 12 ea	Stainless metal sponge
_____ 12 ea	2 qt round storage container w/lid	_____ 12 ea	Green pad
ICE STORAGE/TRANSPORTATION			
_____ 1 ea	125 lb ice caddy w/casters	GENERAL CLEANING SUPPLY	
_____ 1 ea	84 ounce plastic scoop	_____ 4 ea	Hand & nail brush
_____ 1 ea	Ice transport bucket	_____ 2 ea	Hi-lo brush w/squeegee
MEAT STORAGE			
_____ 12 ea	Polycarbonate food box, 18" x 26" x 9"	_____ 1 ea	Drain brush
_____ 6 ea	Drain tray for food box, 18" x 26"	_____ 1 ea	Steam kettle brush
_____ 6 ea	Polycarbonate food box, 12" x 18" x 6"	_____ 2 ea	Coffee decanter brush
DRY STORAGE			
_____ 1 ea	Butter wheel	_____ 1 ea	Bake pan lip brush
_____ 2 ea	Stainless steel seasoning dredge	_____ 2 ea	Coffee urn brush
_____ 1 ea	Griddle thermometer	_____ 1 ea	Stack oven brush
STRAINERS			
_____ 1 ea	10" china cap medium mesh	_____ 4 ea	Heavy duty hand brush
_____ 1 ea	8" fine mesh	_____ 12 ea	16 ounce spray bottle
_____ 2 ea	8" double medium mesh	_____ 144 ea	Hand towel
_____ 1 ea	10" double medium mesh	_____ 2 ea	Mop bucket & wringer
_____ 1 ea	14" reinforced double medium mesh	_____ 2 ea	Mop
_____ 1 ea	8" dia bouillon strainer	_____ 2 ea	Wet floor sign
_____ 1 ea	6" Perforated stainless skimmer	_____ 1 ea	Counter brush
_____ 1 ea	Culinary fry basket, 1/4" mesh	_____ 2 ea	Floor broom
THERMOMETERS			
_____ 2 ea	0° - 220° pocket test 6" calibratable stem	_____ 12 ea	28 gallon gray trash can w/lid
_____ 2 ea	50° - 550° pocket test 6" calibratable stem	_____ 4 ea	Dolly for 28 gallon trash can
_____ 1 ea	50° - 550° kettle thermometer with side clip	_____ 4 ea	Rectangular trash can
As needed	Candy thermometer		
As needed	Oven thermometer		
As needed	Refrigerator thermometer		

†Suggested quantities are only a guide. Your quantities may vary based on your operational needs.

3M.....www.3m.com
 AJM Packaging Corp.....www.ajmpack.com
 Allied Metal Spinning Corp.....www.alliedmetalusa.com
 Anchor Hocking.....www.anchorhocking.com
 APW Wyott.....www.apwwyott.com
 Arden-Benhar Mills.....www.ardencompanies.com
 Bar Maid.....**NEW**.....www.barmaidwashers.com
 Blaze.....www.blazeproducts.com
 Bloomfield/Carrier.....www.wellsbloomfield.com
 Boyd Products.....www.boydproducts.com
 Bunn-O-Matic.....www.bunnomatic.com
 Cactus Mat.....www.cactusmat.com
 Cambro.....www.cambro.com
 Cardinal.....**NEW**.....www.cardinalglass.com
 Carlisle.....www.carlislefsp.com
 Chef Master.....www.chef-master.com
 Chef Revival.....www.chefrevival.com
 Continental.....www.continentalcommercialproducts.com
 Cooper-Atkins.....www.cooperinstrument.com
 Crewware.....www.crewware.com
 Daymark Safety Systems.....www.daymark.biz
 Dexter Russell.....www.dexter-russell.com
 Disco.....www.continentalcommercialproducts.com
 Discovery Products Corp.....www.discoveryproducts.com
 Edlund Company Inc.....www.edlundco.com
 Focus FS/Regalware.....www.focusfoodservice.com
 Forschner/Victorinox.....www.swissarmy.com/
 G.E.T. Enterprises, Inc.....**NEW**.....www.get-melamine.com
 Goldmax Industries, Inc.....www.goldmax.com
 Hall China.....www.hallchina.com
 Hamilton Beach.....www.hamiltonbeach.com
 Handgards.....www.handgards.com
 Handi-foil of America Inc.....www.handi-foil.com
 Handy Wacks.....www.handywacks.com

Havells /Sli.....www.havells-usa.com
 Jaccard.....www.jaccard.com
 Johnson Diversey.....www.jdbrands.com
 Libbey Inc.....www.libbey.com
 Marko by Carlisle.....www.marko.com
 Mundial.....www.mundialusa.com
 National Checking.....www.nationalchecking.com
 Nemco Food Equipment.....www.nemcofoodequip.com
 O'Cedar.....www.ocedarcommercial.com
 Oneida Ltd.....www.oneida.com
 Oreck Commercial.....www.oreckcommercial.com
 Procter and Gamble.....www.pgbrands.com
 Reckitt Benckiser.....www.reckittprofessional.com
 San Jamar.....www.sanjamar.com
 Serving Solutions.....www.servingsolutions.com
 Smith-Lee.....www.hoffmaster.com
 Spectrum Plastics, Inc.....www.spectrumbags.com
 Syracuse China.....www.libbey.com
 T&S Brass.....www.tsbrass.com
 Tablecraft.....www.tablecraft.com
 Taylor.....www.taylorusa.com
 The Sterno Group.....www.thesternogroup.com
 Tolco.....www.tolcocorp.com
 Traex.....www.libbey.com
 Update.....www.update-international.com
 Vertex.....**NEW**.....www.vertexchina.com
 Vita-Mix Corp.....www.vita-mix.com/foodservice
 Vollrath Co. LLC.....www.vollrathco.com
 Walco Stainless.....www.walcostainless.com
 Waring.....www.waringproducts.com
 Winco.....www.wincous.com
 Win-Holt Equipment Group.....www.winholt.com
 World Tableware.....www.libbey.com